

**THE LIGHTING BIBLE® 14**

 **DELTA LIGHT®**

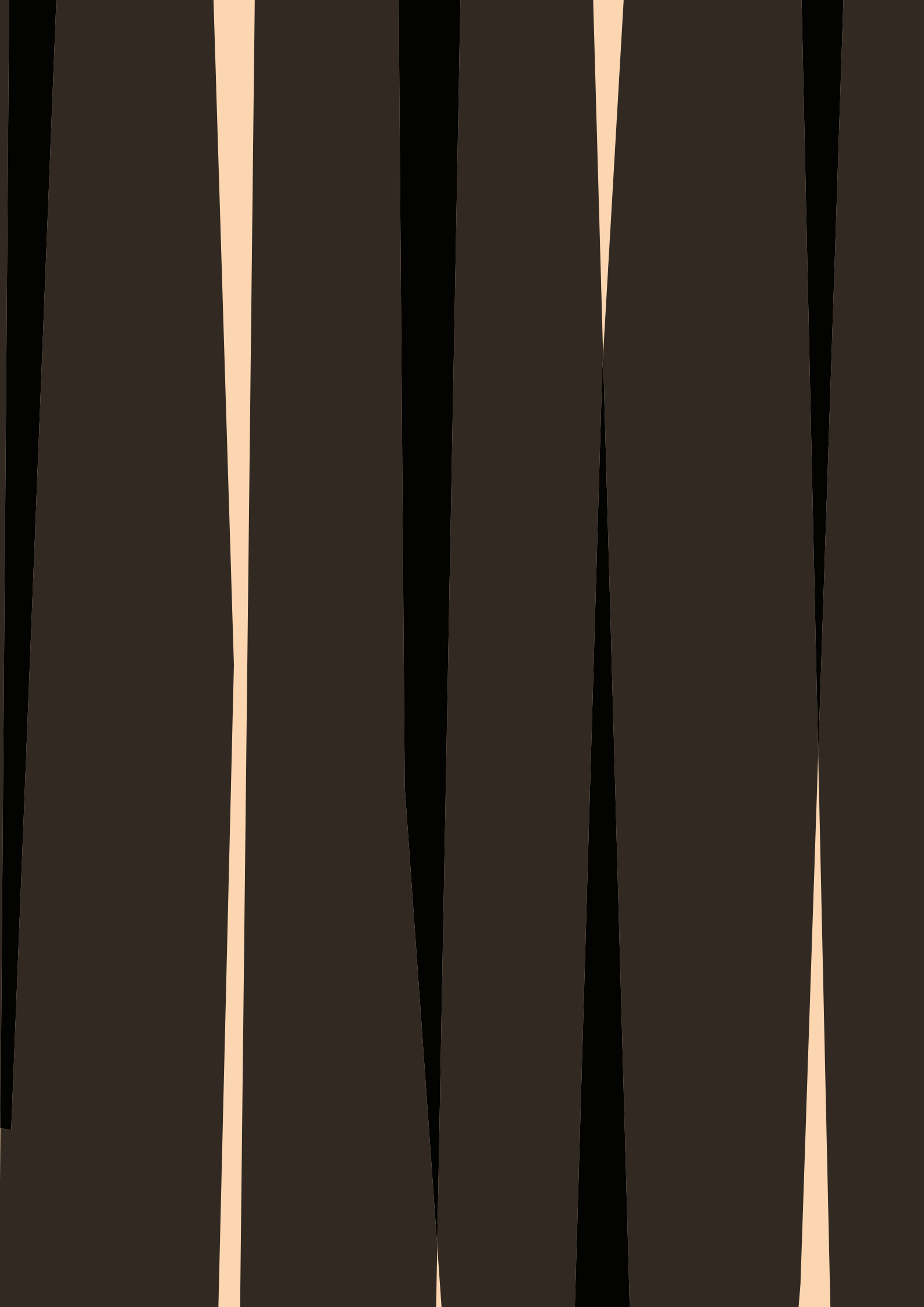

**WELCOME**

TO OUR WORLD.



# IMAGINE

**The Lighting Bible 14 – IMAGINE**, invites you on a journey of inspiration.

A world of wonder to explore new ideas and an escape into enlightenment.

Abundantly illustrated with breathtaking photography of architectural realisations from across the globe, The Lighting Bible 14 – Imagine, represents our craft, where we dream up a world of light.

You will find plenty of information about our collection of architectural lighting solutions throughout these pages. Are you looking for in-depth technical product details?

Extensive product information can be found throughout our website. [deltalight.com](http://deltalight.com) offers you complete, up to date product information at your fingertips.

Head over to [deltalight.ca/14](http://deltalight.ca/14) - [deltalight.us/14](http://deltalight.us/14) to request your copy today.

**PURE  
LIGHTING  
PLEASURE.**

 DELTALIGHT®

Purity is key in our latest edition of  
The Lighting Bible. Deep in the core of our  
DNA is the mission for Pure Lighting Pleasure.

The Lighting Bible 14 brings you a collection  
of pure lighting experiences with a language  
of its own to enhance the human experience  
of architecture and nature. Our luminaires offer  
the building blocks for unique creations of  
brightness, atmosphere, and emotion.

Sophistication in technology and purity in  
design unite in our collection. We offer  
lighting that pushes the boundaries of  
technology and engineering whilst bringing  
a feeling of comfort, elegance, excitement  
and purity. Explore our complete collection  
of lighting solutions and experience pure  
lighting pleasure.



# WE MAKE LIGHT

that makes you see.  
Light that makes you look.  
Light that animates the world,  
around you.

**PAUL AMELOOT**



Jan, Paul & Peter Ameloot





### **WE MAKE LIGHT**

We develop lighting solutions to improve people's quality of life. We offer our lighting expertise to architects, interior designers and lighting designers, to help them realise their vision and create a lighting scenography that integrates into the architecture. Using the right lighting, in the right way, enhances and complements architectural concepts.

We strive to be the very best in everything we do. With our extensive experience in product development, manufacturing, and design since 1989, we approach the future with ambition and confidence. We continuously invest in people, new markets, production technologies and our infrastructure - to improve our service capabilities, expand our R&D department, test facilities and laboratory, increase the level of warehouse automation and expand the House of Light training centre. As a family business, we are happy to share our passion, creativity, and dedication. Our aim is to inspire people all over the world. As a family, we have a personal stake in making your project a success.

### **PAUL AMELOOT**

Entrepreneur Visionary Designer

Paul Ameloot created Delta Light in 1989 in the Belgian city of Roeselare, realising his dream to design and manufacture architectural lighting. The local success story soon went global, with the participation in international events from the get-go. Today Delta Light is active on all continents, while still honouring our local roots. "I started out designing and developing all products myself. Even though today we have a team of 35 engineers, I still contribute my vision and ideas. Because once a player, it's hard to become a fan, sitting on the bench and watching the game. My dream really came true, not to forget, together with my wife Katrien. Our sons, Peter and Jan, continue to make that dream grow."



**WE  
ARE  
DELTA  
LIGHT**



# IN-HOUSE DESIGN

The lighting industry is constantly evolving, providing both challenge and opportunity. It fascinates us to keep on bringing **new designs and lighting solutions** to the market. You could consider it a passion to continuously surprise and inspire people with new lighting languages.

An essential attribute in Delta Light's creative process is the extensive in-house design, development, testing, engineering, and manufacturing of all products. This enables us to achieve our short idea-to-market philosophy, resulting in extensive new collections being launched on a regular basis.

Our **in-house design team** crafts cutting-edge lighting solutions, that combine an architectural design language, a minimalist approach, and a boldness that challenges the boundaries of technology. In-house design is the foundation of our product portfolio, but we also love to collaborate with **architects and designers**, from different industries to create and innovate.

Delta Light's extensive design and R&D teams are constantly discovering future trends, both in terms of design and use of materials, whilst remaining focused on **the power of imagination**. Its creative statement is supported by the opinion of expert panels, resulting in prestigious awards for our collection of products, including IF Design Award, Good Design Award, Red Dot Design Award plus many more..

We are focused on the detail. The looks, how a fixture moves, how it can be specified and installed, the ease of enjoying the light and so much more. With a surprising visual simplicity, our products are the result of extensive research and testing, fusing advanced technology with timeless design and sustainable materials.

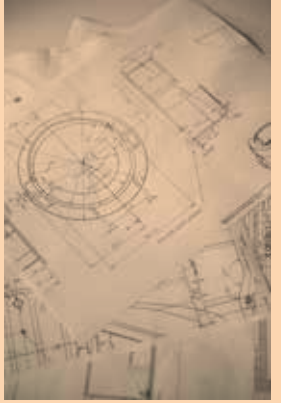



#### CONTINUOUS RESEARCH & INNOVATION

Delta Light has been at the forefront of lighting technology for over 30 years now, and we continue to push boundaries, both in interior and exterior lighting. Our investment in R&D, production and innovation aims to deliver outstanding luminaires, blending contemporary design with high-quality materials, advanced engineering, the very best performance and a long lifespan.

# RESEARCH & DEVELOPMENT



#### CUTTING-EDGE LED TECHNOLOGY

As luminaire designers and manufacturers, we always strive to create the best possible thermal conditions in the luminaire, to ensure the LEDs operate at their optimum. From the design of the LED circuit boards and heat sink, to the selection of materials, to the assembly process and installation techniques... everything is engineered to reach optimal life expectancy and maximum efficiency.

By partnering with the best LED suppliers in the world, we ensure a consistent LED selection with color uniformity across all product ranges. A minimum of MacAdam Step 2 is standard throughout our collection, whilst many of our new collection LEDs offer MacAdam Step 1.

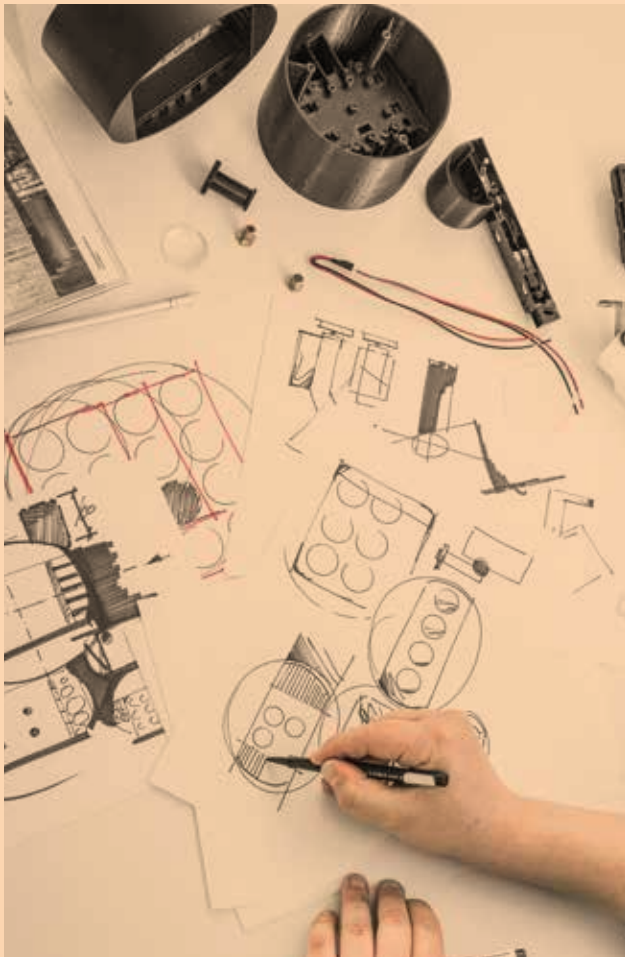



#### **CERTIFIED LABORATORY TESTING**

Product quality and safety testing within our Delta Light laboratory conform to the International Electrotechnical Commission standards. The close cooperation and CTF stage 3 acceptance with our certifying partners SGS-CEBEC and INTERTEK leads to CE, ENEC and CB certifications for European and IEC member countries [www.members.iecee.org/](http://www.members.iecee.org/)

Our laboratory also covers the certification of products for the North American market by being certified as a level 4 satellite laboratory for INTERTEK.

This allows us to efficiently obtain the cETLus listing for our standard North American product range and provide exceptional service for even the most demanding customer specific solutions. [www.intertek.com/directories/etl-listed-mark/](http://www.intertek.com/directories/etl-listed-mark/)





### ADVANCED OPTICS

Delta Light's team of engineers and optic experts are on a continuous quest to match the company's credo for design with energy-efficiency and optimal quality of light. Delta Light's collection is ready to meet the needs of today's architecture, interior and landscape design, and to illuminate with impact.

We offer different precision light distributions to fulfil various requirements, with high uniformity, for demanding applications. CAD-engineered and precision manufactured lenses deliver a tightly controlled light distribution. The variety of optics, beams and other features enable designers to meet the various illumination needs.

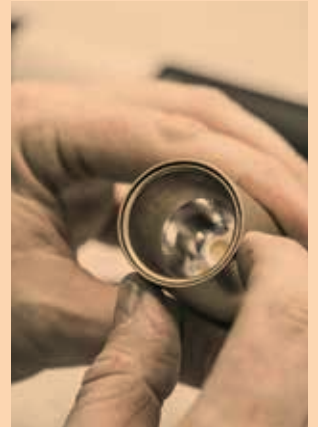

### STATE OF THE ART DEVELOPMENT TECHNIQUES

An important feature in Delta Light's creative process is the use of state-of-the-art development techniques. The intensive use of 3D printing, early stage FMEA (Failure Mode and Effect analysis), goniophotometer measurement and an in-house third party recognised lab (SMT/CTF/satellite data acceptance) result in a fast, efficient and 'first time right' development process. As such, it is an essential attribute in the company's short idea-to-market philosophy.

Throughout the entire production process Delta Light distinguishes itself by handling **the strictest quality parameters**, to ensure products and services are designed and produced to exceed customer requirements. Every step in the production process has a routine quality procedure, covering both product quality and testing. Every single product that leaves Delta Light, has been inspected and tested thoroughly, resulting in minimal returns and maximum efficiency.







#### **HIGH-QUALITY**

Delta Light maintains the highest standards in everything we do – including in the choice of materials, the technology and the coating process. Many of our product ranges feature special coating on critical parts (e.g. screws, bolts, latches etc), combined with high-quality alloy and specialist paint.

To avoid the problem of oxidation and corrosion of outdoor products, Delta Light uses a prime selection of aluminium alloys with a low content in copper. The protection by anodizing treatment, on all suitable components including die-cast aluminium ones, improves the resistance against corrosion. The titanium-based conversion layer offers a further protective layer for protection prior to the final polyester painting.

We apply extensive pre-painting surface treatments for maximum protection against corrosion, such as acid washing to clean the surface, rinsing with demineralized water to remove residue, and the application of a chemical conversion treatment to protect against rusting.

Our polyester powder color coating is based on saturated polyester resins, electrostatically applied and oven cured at 200°, guaranteeing high resistance to atmospheric ageing and UV light exposure. Extra resistant surface paint is guaranteed by filiform corrosion testing with an exposition of over 1500h.

All coating procedures are followed by daily careful testing. Strict controls are constantly maintained over the parameters of every step in the process, such as purity, pH, chemical concentrations, temperature, etc. This ensures the best achievable substrate penetration and uniformity of the conversion coat, thereby ensuring optimum corrosion resistance and powder-coat adhesion.





Architect warchitekten

Architect ANARCHITECT



Interior Design Omar Abdelghafour - Light Space Design / Concept Black For Green Scape



Architect Mallol Arquitectos / Lighting By Led Life Panama



Architect Studio2 Architects

Architectural Project Dino Krizmanić, Leonid Zuban (Urbis) / Lighting Design Dean Skira (Skira)

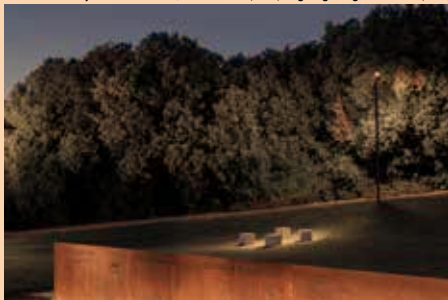

Architect VK Architects & Engineers



# GLOBAL

Since our foundation in 1989 we have developed from a small Belgian company to become a global business, offering lighting solutions and services in 120 countries worldwide.

In addition to the Belgian headquarters we have Delta Light branch offices and partners on all continents and in key design capitals, from Miami to Bogota, Amsterdam to Dubai, Saint-Petersburg to Hong Kong, New York to Milan, Toronto to London and many more. Our goal is to support the international projects personally and locally.

Delta Light caters for some of the world's most well-known brands and architects, providing sophisticated and value add lighting solutions to **residential, office, hospitality, retail, landscaping, showroom, and public projects**. From small to super large scale, Delta Light has the product range, experience, and knowledge to meet the functional and aesthetic needs of your projects.

Each project requires a customised approach, and as such Delta Light recognises this with an exceptional package of services and design tools. Our global team works with all stakeholders involved to achieve the best possible results.

Starting with initial concept lighting support to the installation process and project follow-up, and everything in between. Be it for technical or application questions, performance and energy saving studies, custom designs, and made-to-measure solutions, rendering or graphics, or any other lighting support needs... Delta Light provides a one-stop-shopping solution for your projects.

Architect Arias Serna Saravia



# SUSTAINABILITY

We recognise that our business activities are associated with responsibility for ecological awareness and health and sustainability, and as such we treat these issues as a priority.

Our quest for sustainability at Delta Light is translated in continuously striving to make our products and operations more efficient, durable and environmentally friendly. With each new collection, come new technological developments, evolutions in recyclability, and in efficiency of material use, production and transportation. These efforts have seen us win awards such as Lighting For Good Awards in 2019 and 2020.

Today we can say our production operates on a self-powered renewable energy model. Our headquarters in Belgium are equipped with solar panels that provide enough solar energy to cover the energy need of our entire production line and of the office site.

Recycling and production waste management is a key theme that is reflected in our production processes, such as our handling of aluminium scrap. Many of our luminaires are created from aluminium profiles. We optimise the usage of these profiles; however, waste is inevitable. As aluminium is 100% recyclable, all aluminium waste is collected for recycling.

At our Belgian headquarters and at our global offices we take pride in providing a healthy, safe, and balanced environment for all employees. Our efforts in sustainability and wellbeing as an employer and manufacturer have earned us a 2019 Silver Medal by the independent monitor Ecovadis.



**THINGS  
TO SEE.**



**MULTINOVA**  
**MULTI-APPLICABLE**

Multinova has something familiar and something fresh at the same time. As a disc of light, Nova refers to the Supernova range, as both families share similarities in looks and ways of installation. But Multinova is slimmer and has some additional features to make it multi-applicable, hence Multi in the name.

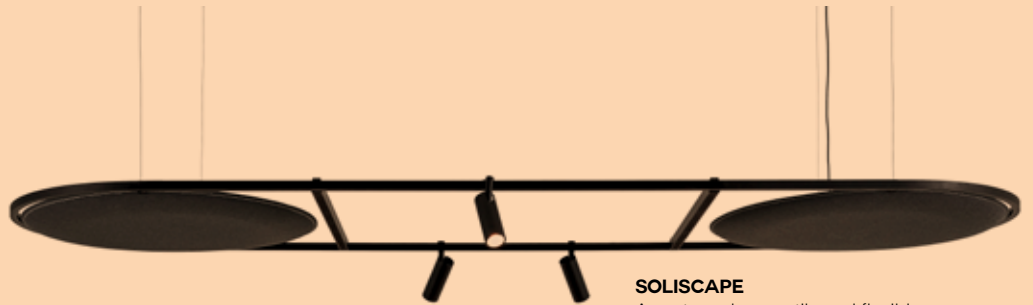

**SOLISCAPE**

An extremely versatile and flexible system, specifically designed to create human-centric environments. Developed together with **UNStudio**, Soliscape combines lighting, acoustics and IOT into an aesthetically appealing solution. Soliscape presents a toolbox with flexible components to architects and designers, to create unique constellations in human-centric environments.

**HALOSCAN,**  
**DESIGN FOLLOWS OPTICS**

Designed around its flat optics, Haloscan combines ultra-minimalistic looks with a pleasurable light effect. With its different finishing colors, multiple beam angles and various installation options, Haloscan is perfect for creative compositions throughout an entire project.

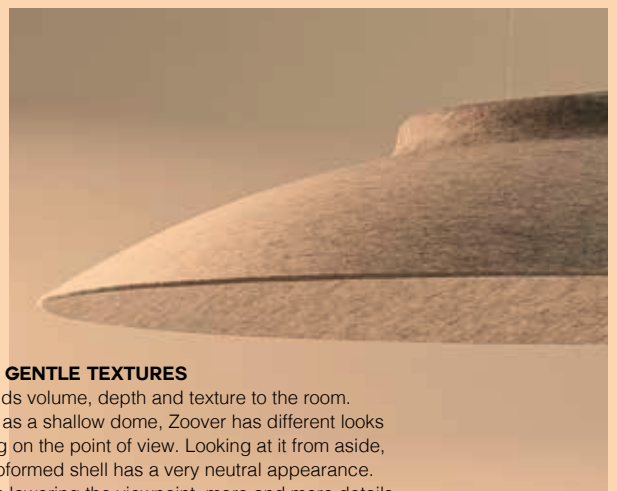

**ZOOVER, GENTLE TEXTURES**

Zoover adds volume, depth and texture to the room. Designed as a shallow dome, Zoover has different looks depending on the point of view. Looking at it from aside, the thermoformed shell has a very neutral appearance. Only when lowering the viewpoint, more and more details catch the eye: a performant light grazing the inner dome.



#### A NEW TAKE ON SPY

In our continuous search for better user comfort with more precise optics and better light control, the complete Spy range has been upgraded. The result? Fresh shapes and additional finishing colors, better light comfort through hybrid optics, improved LED color consistency and new perspectives with Tunable White and Soft Dim.



#### VISUAL COMFORT FOR OFFICES

The Lighting Bible 14 offers a whopping new array of technical architectural office lighting. Each with its own set of technological advantages and unique design language. While Inform focuses on Melanopic Light Technology (MLT), Conform by Dean Skira is equipped with Natural Light Technology (NLT). Both technologies are developed in-house and are focused on human wellbeing, to boost and support the human circadian rhythm.



#### NEXT GENERATION

This Bible is not only filled with novelties, some longstanding Delta Light classics got upgraded too. Fresh designs, a more modern look, better CRI, new or improved optics, ... ready to shine on in the coming years. Have a look at the redesigned Kix, our upgraded Spy family, Minigrid and Deep Ringo extensions, the rebirth of Backspace and Walker, and more.



#### CONNECTED SURFACES

First introduced in 2003, Connect was based on 2 fluorescent tubes facing opposite directions to graze light on 2 right-angled surfaces. Today, Connect balances on the edge between wall and ceiling or wall and wall, as you like.





#### **INVISIBLE YET TANGIBLE**

Impressed by his extensive expertise and passion during the design of the Polesano, we decided to go on our next adventure with lighting designer Dean Skira. Together with Dean we take you on a journey to the ultimate minimalism, introducing Nime.



#### **5 YEAR WARRANTY**

At Delta Light we have full confidence in the quality of our products. All of our products are designed and manufactured according to the highest standards, using nothing but the best parts and technology. As a proof of our commitment we offer a 5-year LED warranty, starting as from the date of delivery of the product to the authorised distributor of Delta Light NV. Read about the details and conditions on the Delta Light website.

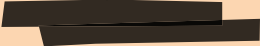

#### **LIGHT QUALITY OUTDOOR**

Delta Light's team of engineers and optic experts is on a continuous quest to match the company's credo for design with an optimal quality of light. With the new Frax we have taken our fascination for the perfect beam outside. Clean-cut light distribution to boost your outdoor experience.

#### **TECHNOLOGY EMBRACED**

Color consistency has always been a point of attention within the Delta Light product range. Up till now we have been using SDCM 2 - the best available – but in this Lighting Bible we introduce COB LEDs with SDCM 1, together with COB LEDs in Tunable White or Soft Dim. Lots of new solutions within both existing and new families.

DALI is one of the most frequently used dimming systems for projects no matter what scale. As leading company in lighting and member of DiiA, we embrace new technologies and a transition

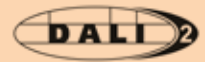

to DALI-2 is a logical next step. As such, all DALI dimmable luminaires and remote drivers in this edition of the Lighting Bible are DALI-2 compliant.

New installation facilities are available in our exterior products by offering 24V-DC solutions. Beloved families like Kix and Logic now come with a 24V-DC convertor included, making it possible to put a save 24V-DC line throughout the garden and connect the luminaires in parallel.

**DESIGN  
COLLABS**

Throughout our history we've focused on creating lighting solutions that can enhance any building or setting. For some of these collections we have collaborated with external designers, opening up new exciting adventures in lighting.

Merging the vision and concepts of these leading architects and designers with our in-house R&D and production expertise, exemplifies how Delta Light, hand-in-hand with them, continues to step into the future.

# UNStudio

## SOLISCAPE

UNStudio, founded in 1988 by Ben van Berkel and Caroline Bos, specialises in creating ground-breaking architecture and design at all scales, from bridges to public buildings, offices, residences, exhibitions, products and urban masterplans. With over 120 completed projects in Asia, Europe and North America, the studio continues to expand its global presence with recent commissions in the United Arab Emirates, China, South Korea, Italy, Germany and the United States, amongst other countries. The name UNStudio stands for United Network Studio and refers to the collaborative nature of the practice.

*"As what we design today is normally built in three to five years' time, we're used to working with the future in mind. However, the future is changing faster than ever before. Even the most accurate predictions can be made redundant by a sudden advance in technology. To ensure we don't contribute to a waste of materials and investment that is no longer sustainable or appropriate in today's world, we develop strategies that not only anticipate the future, but possible changes to that future as well."*

UNStudio and Delta Light have joined forces to endeavour to improve the wellbeing of people in our rapidly changing work environments, where human health and the war on talent have become a primary focus of employers. Together we developed SOLISCAPE, a lighting system that facilitates, responds, and contributes to solving these complex challenges. An extremely versatile and flexible lighting toolbox specifically designed to create human-centric environments.



**BEN VAN BERKEL**

Professor AA Dipl. (Hons), (F)RIBA, Hon. FAIA  
Founder / Principal Architect UNStudio  
Founder UNSense

In 2018 Ben van Berkel founded UNSense, an Arch Tech company that designs and integrates human-centric tech solutions for the built environment. Ben van Berkel has lectured and taught at many architectural schools around the world.

From 2011 to 2018 he held the Kenzo Tange Visiting Professor's Chair at Harvard University Graduate School of Design, where he led a studio on health and architecture. In 2017, Ben van Berkel also gave a TEDx presentation about health and architecture. In addition, he is a member of the Taskforce Team/Advisory Board Construction Industry for the Dutch Ministry of Economic Affairs.



# DEAN SKIRA

## **NIME - CONFORM**

Dean Skira is the founder of Skira, an award-winning practice based in Pula (Croatia) with projects also in the EU, Middle East, Russia, Canada, and the United Kingdom. For the past 30 years, he is building and creating mostly with intangible forms while working with investors, architects, and designers to create meaningful lighting experiences.



## **NIME**

The absence in its presence  
The presence in its absence

With a miniature aperture of only 3/8" - 10mm, Nime focuses on what is important and puts it in the spotlight. It is not about Nime, it is about what Nime can do. The combination of its focusable beam angle together with its adjustability allows for a multitude of application possibilities, while maintaining a uniform, minimalistic look and feel throughout the project.

## **CONFORM**

Comforting for the human eye, showing vibrant colors, and boosting human activity.

Its elegant design with multiple color combinations, its specific sun mimicking spectrum, its low UGR, its well-balanced down-up ratio... Conform is designed around the light. It not only perfectly embraces the light source, but it reinforces it in multiple aspects. Conform uses Delta Light's Natural Light Technology (NLT), state of the art LEDs with a spectrum that very closely matches that of the sun.

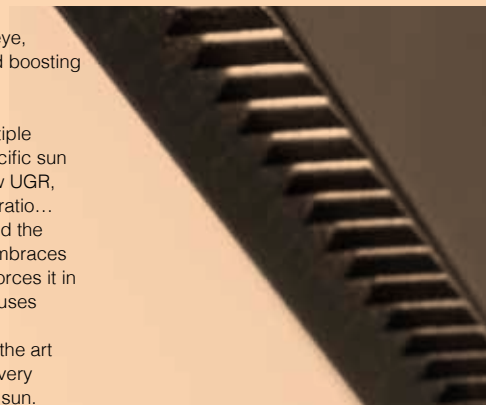

# OMA

## XY180

OMA is an international practice founded by Rem Koolhaas, operating within the traditional boundaries of architecture and urbanism. AMO, a research and design studio, applies architectural thinking to domains beyond. XY180 is a 3-piece collection of luminaires designed by OMA. The collection was born from a fascination with point, line and surface, key characters in the discourse of architecture. The collection uses precise geometric proportions. The base elements, which include a tube light and a spotlight, can be combined with a hinge, to generate countless light conditions, both essential and complex.

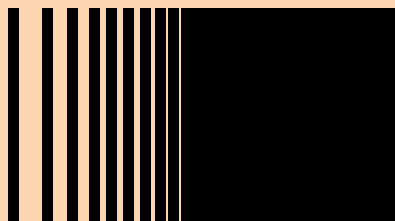

# NITEO LIGHTING

## NEEDLE

Niteo Lighting is a Seattle based lighting design practice, founded by Jason Edling & Key Anderson, utilizing their previous +25 years of project experience. Niteo aims to engage clients in an intimate, technically savvy, dialogue that allows project stakeholders to collectively contribute to the design process. Their impressive portfolio contains museums to hospitality, retail, residential, landscape and art installations. Niteo and Delta Light collaborated on the design of the Needle, an elegant and playful luminaire cleverly peeking around, throwing a light wherever needed.





**CHAPTER  
INDEX**



# 328 – 437

## PROFILES

SPLITLINE M20 / SPLITLINE M52 / SHIFTLINE M26L / MATRIX /  
SHIFTLINE M26H / SHIFTLINE M35R / SHIFTLINE M44 /  
SHIFTLINE 19 / SPLIT-IT / TAGLINE / CONNECT / DOT.COM WALLWASH /  
FEMTOLINE 25 / FEMTOLINE 35 WG / FEMTOLINE 35 / FEMTOLINE 45 /  
ONE-AND-ONLY / BORDERLINE / MICROLINE TR / MICROLINE 40/60 /  
STREAMLINER / SHELFLINE

# 2 – 253

## INTERIOR CEILING

NIME / IMAX / ENTERO / SNEAK-R / CARREE /  
REO / ARTUUR / DEEP RINGO / PARTOU / GRID / MULTINOVA /  
SUPERNOVA XS / SUPERNOVA FLAT / SUPERNOVA / XY180 /  
PUNK / HEDRA / VIZIR / NEEDLE / BOXY / DOT.COM / DOT.COM WALLWASH /  
HALOSCAN / TWEETER / ODRON / BOWIE / PION / SPY / SUPER-OH! SLIM /  
SUPER-OH! / SUPER-OH! XS / SUPERLOOP SBL / SUPERLOOP PLUS /  
SUPERLOOP MDL / SOLISCAPE / LASS-OH! / INFORM SQ / INFORM R /  
CONFORM / ONE-AND-ONLY / STREAMLINER / GIBBO / MILES /  
SOIREE / ZOOVER

# 438 – 467

## EXTERIOR CEILING

REO X / DEEP RINGO X / CARREE X / BOXY

# 254 – 307

## INTERIOR WALL

LOGIC W / TAGLINE / INLET / LEDS C / HELI / MONTUR / FORTY-5 /  
ORBIT / TOPIX / VISION / TIGA / BACKSPACE II / WALKER II

# 468 – 509

## EXTERIOR WALL

LOGIC W / LEDS C / LEDS GO / HELI X / TOPIX /  
WALKER II / TIGA / MOMBA / MONO II / MONTUR /

# 308 – 327

## TRACK

FRAGMA / MULTINOVA / SUPERNOVA XS

# 510 – 567

## EXTERIOR FLOOR

LOGIC / LOGIC F / LEDS C / LEDS GO / KIX / FRAX /  
MONTUR / WALKER II / MONOPOL /  
SPYKER / BAZIL





INTERIOR

# CEILING

# RECESSED

NEW

**NIME**

P 12



**IMAX II**

P 20

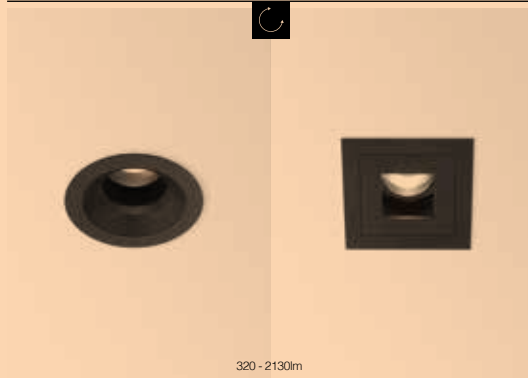

320 - 2130lm



NEW

**ENTERO**

P 30



390 - 4580lm



3 SIZES

**SNEAK-R**

P 34



1630lm



**CARREE**

P 40



810 - 1130lm



NEW

**REO**

P 48

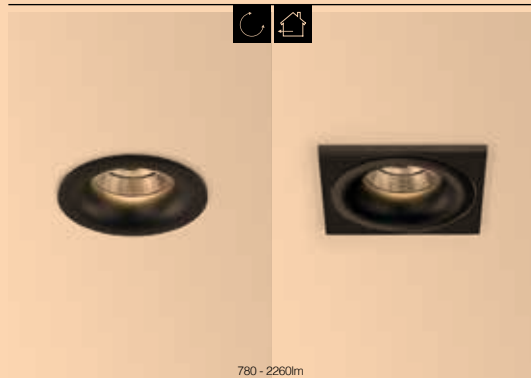

780 - 2260lm



3 SIZES



**NEW**  
**ARTUUR**  
P 58

**PRO**



790 - 1090lm

**NEW**  
**DEEP RINGO**  
P 66



780 - 1130lm

● ●  
2 SIZES

**NEW**  
**PARTOU**  
P 74



780 - 1080lm

● ●  
2 SIZES

# RECESSED & SURFACE

## GRID

P 78

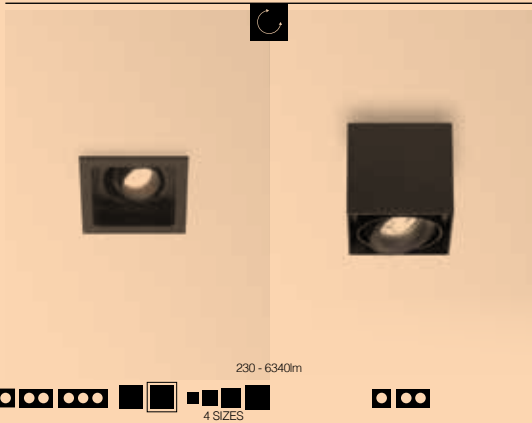

NEW

## MULTINOVA

P 88

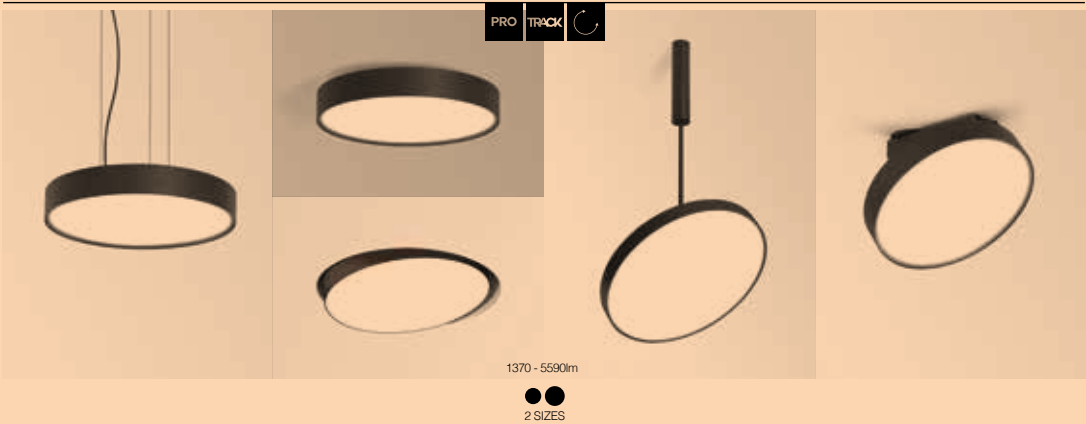

## SUPERNOVA XS

P 94

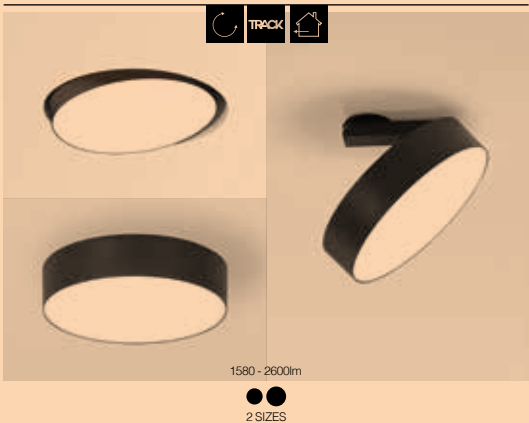

## SUPERNOVA / FLAT

P 96



### DOT.COM

P 140

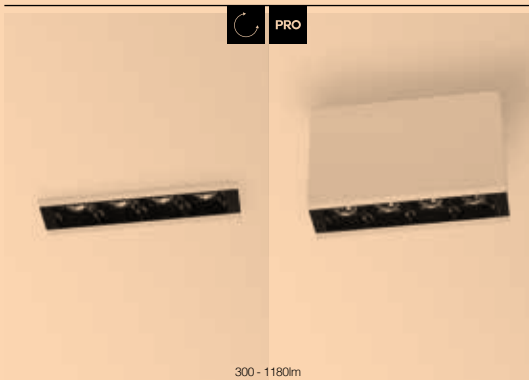

3 SIZES

300 - 1180lm

### DOT.COM WALLWASH

P 142

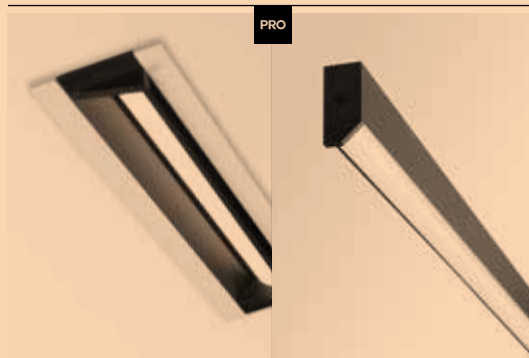

1000 - 3000lm

4 LENGTHS

NEW

### HALOSCAN

P 150



300 - 1180lm

### TWEETER

P 156

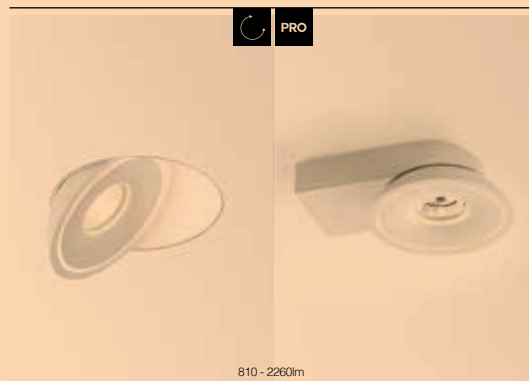

810 - 2260lm



NEW

### ODRON

P 162



NEW

### BOWIE

P 164



NEW

### PION

P 166



# RECESSED & SURFACE

**NEW**  
**SPY**  
P 172



**SPY FOCUS**  
P 178

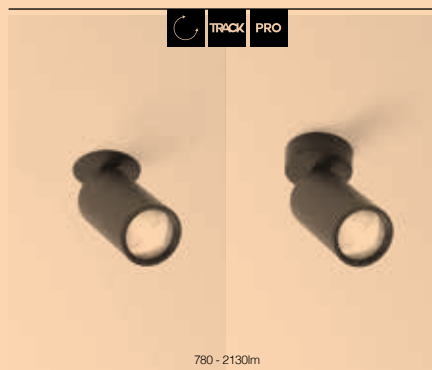

**NEW**  
**SUPER-OH!**  
P 182





# SURFACE

INTERIOR CEILING

**NEW**  
**MULTINOVA**  
 P 122

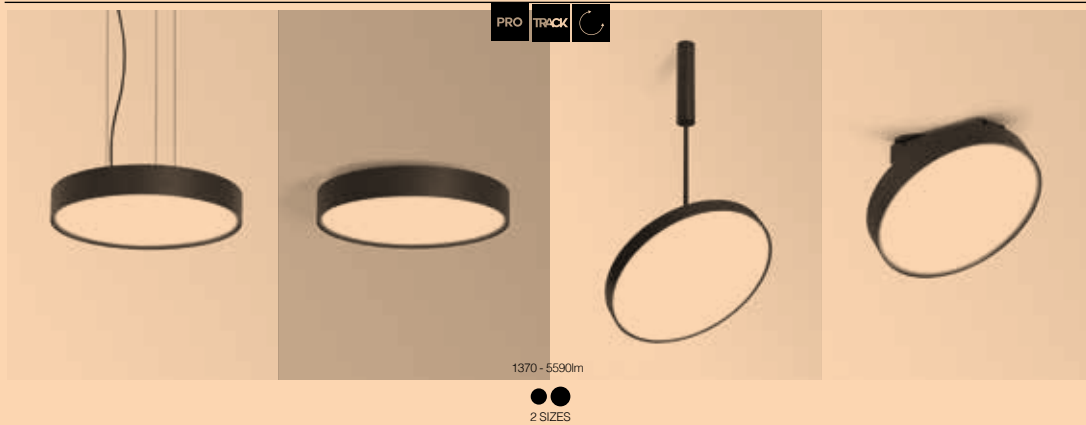

**XY180**  
 P 60



**PUNK**  
 P 114



**HEDRA WIZIR**  
 P 120



**NEEDLE**  
 P 128



**BOXY**  
 P 132



LUMEN OUTPUT mentioned as indicative reach.

# SURFACE

NEW

## SUPERLOOP

P 140



2800 - 33000lm

10 SIZES

NEW

## SOLISCAPE

P 142



NEW

## INFORM

P 222

PRO

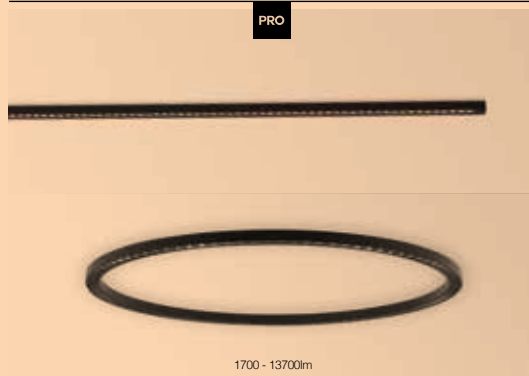

1700 - 13700lm

3 LENGTHS

## LASS-OH!

P 280

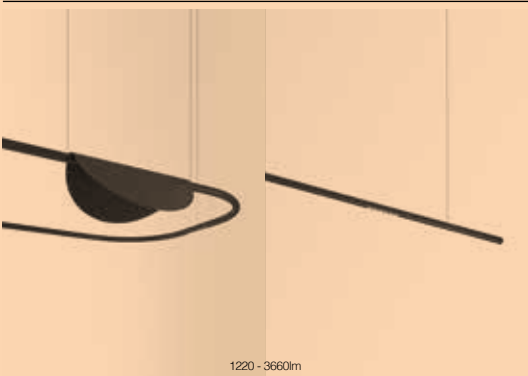

1220 - 3660lm

NEW

## CONFORM

P 228



3900 - 7700lm

3 LENGTHS

## ONE-AND-ONLY

P 232

PRO



6100 - 9900lm

2 LENGTHS

## GIBBO

P 236

PRO



810lm

### MILES

P 240



### SOIREE

P 244



NEW

### ZOOVER

P 250





# NIME

PATENTED

**THE ABSCENCE IN ITS PRESENCE,  
THE PRESENCE IN ITS ABSCENCE.**

The black hole reflects no light, but the light of Nime finds its way out.  
The tangible part disappears inside its heart, and the intangible part  
illuminates the object.

## **THE FIFTH FORM OF LIGHT**

The first form of light is  
in the source.

The second is  
the invisible form of light itself.

The third is the form of the object revealed  
by light before it touches it,  
the fourth is the form of the shadow.

And the fifth is the form of the consequence  
that comprises all the previous four forms, as  
well as the way we feel and experience the  
space considering the four forms.

Design by **DEAN SKIRA** & Delta Light

## **CHOOSE YOUR APPLICATION**

New Construction

## **CHOOSE YOUR CONTROL**

0-10V / Lutron Eco / Lutron 2-Wire

[www.deltalight.us/nime](http://www.deltalight.us/nime)

[www.deltalight.ca/nime](http://www.deltalight.ca/nime)



Better not underestimate Nime,  
as the aperture of only 3/8" / 10mm is only the façade that  
hides away a host of possibilities to control your beam.  
Within the same opening and thanks to an ingenious set  
of custom optics, Nime allows you to focus the beam from  
20° up to 40° and offers rotation up to 355° and tilting up  
to 30°, without changing its looks. With this magic trick,  
Nime lets you:  
Emphasize objects on vertical and horizontal surfaces,  
without visual appearance of the fitting or its source

Light up small to large objects,  
even when they are not aligned with the luminaire.

Perfectly address the light where  
it is needed, even in slope ceilings.

Create equal circles of light from  
both low and higher ceilings.



#### DEAN SKIRA

is the founder of **SKIRA**,  
an award-winning practice  
based in Pula (Croatia).

Dean is travelling in light and  
walking through shadows.  
What started as design work  
with tangible forms, over the  
past 30 years, developed  
into building and creating  
with the intangible and the  
ephemeral.

"At **SKIRA** we refer to  
light as to an intangible but  
powerful building material.  
We create architectural  
lighting and product design  
to suit our projects. By  
understanding light as an  
infinite voyager, we have  
developed skills to capture  
its journey."



**INVISIBLE, YET TANGIBLE.**

The effect is there, but where does it come from? With a miniature aperture of only 3/8" - 10mm, Nime focuses on what is important and puts it in the spotlight. It's not about Nime, it's about what Nime can do.

The combination of its focusable beam angle together with its adjustability allows for a multitude of application possibilities, while maintaining a uniform look and feel throughout the project.











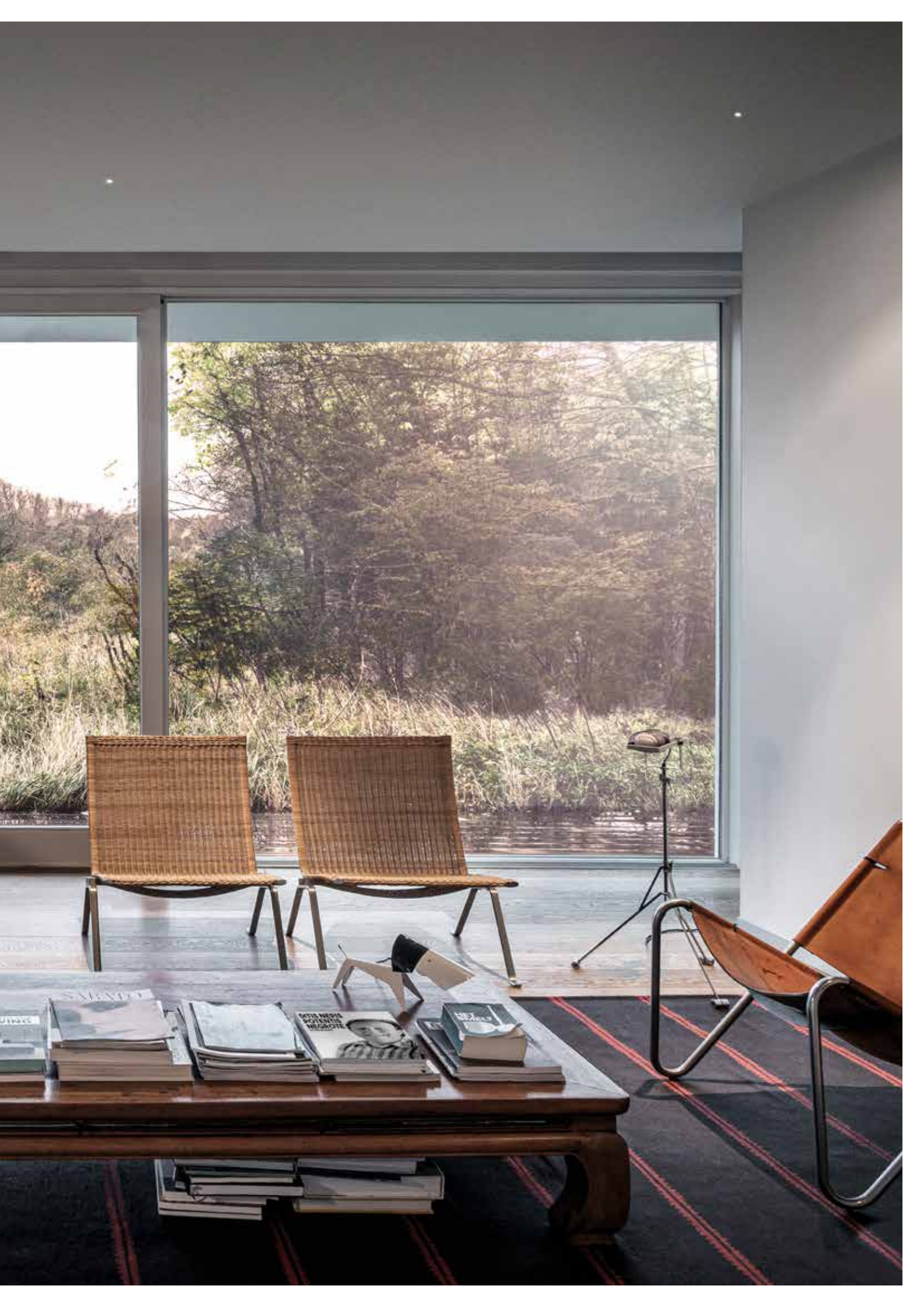



# iMAX

Where the initial evolution in LED and optics focused on better output, smaller chips and longer lifetime, the second evolution is again shifting to user comfort with more precise optics and better light control.

As the purpose of the iMax II family is to provide the best visual comfort to the user - thanks to its recessed LED engine - this range is perfect to build further on this evolution: improved efficiency, improved beam angles and the possibility to combine all versions as they use uniform LED engines.

The iMax II range combines premium LED engines with precise optics, delivering high performance, maximum efficacy and high quality illumination. iMax II is using lenses out of plexiglass HW55, a material able to withstand high temperatures and allowing lumen packages up to 2000lm. Next to the high output, the lenses allow for a perfect control of the beam angle and a high uniformity on the light emitting surface, which results in reduced glare. Furthermore, if a different beam angle is required, the lenses can easily be interchanged.

The round versions with trim within the range are available with a clear glass, offering IP54. This enables you to continue minimalism and uniformity throughout bathrooms, wellness areas and other indoor damp locations.

iMax II fits in The Soft Ceiling concept from Delta Light, as it focuses on minimal appearance, giving focus to the light instead of the fixture. As such, the collection fuses Delta Light's aspirations for design sophistication and attention to detail, with precise engineering and premium materials, resulting in minimal fixtures with maximum impact. The interchangeable tubes and color finishes allow you to apply luminaires that disappear into the background.

[www.deltalight.us/imax](http://www.deltalight.us/imax)  
[www.deltalight.ca/imax](http://www.deltalight.ca/imax)

**FAMILY OVERVIEW**

**CHOOSE YOUR FINISH**



Black / White



Colored tube in Black / Gold Matt / White

**CHOOSE YOUR INSTALLATION**

Trim / Trimless

**CHOOSE YOUR SHAPE**



Round / Square

**CHOOSE YOUR POWER**

Low Power 6,1W – 780lm / 9W – 1080lm  
 Mid Power 11,7W – 1520lm / 17,1W – 2130lm  
 (UGR<19)

**CHOOSE YOUR COLOR TEMPERATURE**

2700K / 3000K / 3500K / Soft Dim

**CHOOSE YOUR OPTICS**

Low Power 12° / 20° / 33°  
 Mid Power 18° / 26° / 39°

**CHOOSE YOUR APPLICATION**

New Construction  
 Remodel

**CHOOSE YOUR CONTROL**

0-10V / Phase Dimming /  
 Lutron Eco / Lutron 2-Wire

**CHOOSE YOUR ACCESSORY**

Honeycomb / Glass SBL / Linear Spread Lens /  
 Softening Lens / Spread Lens

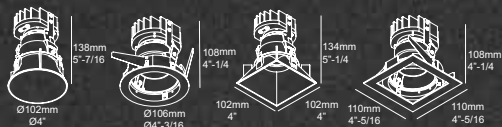

iMax II makes use of hw55 acrylic polymer lenses to obtain its optical characteristics. The lenses not only allow to control the light in the desired way, the specific copolymer material is high heat resistant and therefore higher lumen packages can be reached.

### HIGH EFFICIENCY

Apart from the high light transmission of the lens for optimum efficiency, its specific construction creates a focal point that is not inside the luminaire, but at the height of the opening in the ceiling. In this way, every single ray of light produced by the LED engine is being directed through the lens towards the opening of the iMax II luminaire. This reduces the spill light inside the luminaire and increases its efficiency.

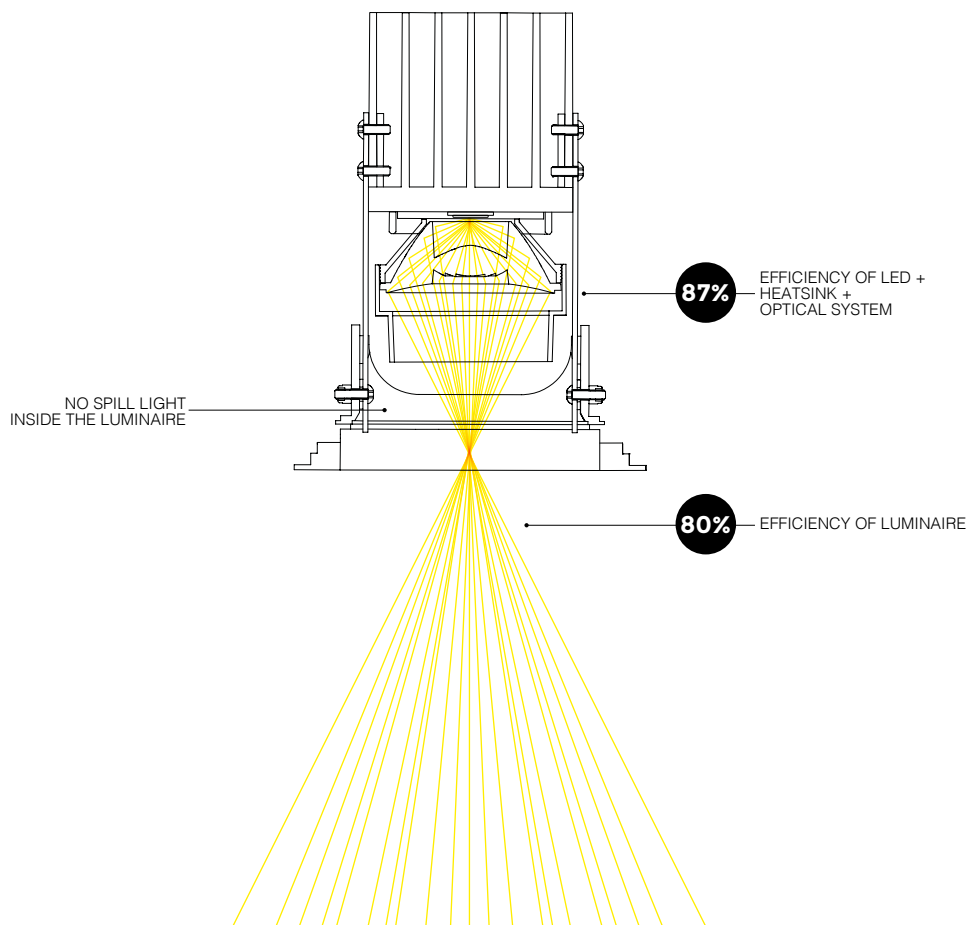

To offer even more flexibility and design freedom to the lighting designer, a range of light refining accessories is available to alter the light effect to the specific needs of the setting. A honeycomb to further minimize the direct glare from the light source, a sandblasted glass to create a diffuse general light effect and 3 specific lenses to either create a more oval or a wider light distribution or to smoothen the edges and create a softer transition.

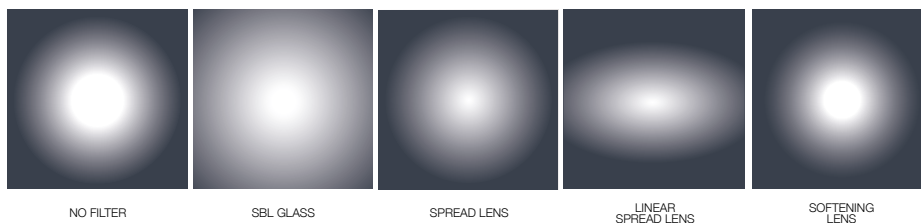



**ADJUSTABLE WITH TRIM**

A versatile accent lighting solution to emphasize individual objects or architectural elements. The tilt mechanism allows the luminaire to be angled with precision up to 30°, allowing for optimum beam alignment. As a result, the light is emitted exactly where you want it. With iMax II Adjustable, the hole in the ceiling is being covered by the trim on the luminaire. It comes as a round or square solution with finishing in white or black and topped off with a colorful tube in white, black or gold.



**ADJUSTABLE TRIMLESS**

A super smooth finish combines ultimate minimalism with maximum eye comfort. This version comes with a trimless mounting kit enabling quick and precise installation and finishing. The interchangeable black, white or gold insert allows you to match the fixture with its surroundings. iMax II Adjustable Trimless is available in a round and square finish.

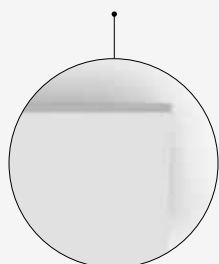



ARCHITECTS DTR STUDIO / LIGHTING DESIGN BIG ARCHITECTURAL LIGHTING / PHOTOGRAPHY CRIS BELTRÁN





ARCHITECT PAOLO COSSU ARCHITECTS / LOCAL ARCHITECT GIULIANA BARILLI



ARCHITECTS DTR STUDIO / LIGHTING DESIGN BIG ARCHITECTURAL LIGHTING / PHOTOGRAPHY CRIS BELTRÁN



ARCHITECT ESTUDIO MORFO / PHOTO LUIS FERNANDO RAMOS



ARCHITECTS KIBA BRAZ ARCHITECTS AND URBAN PLANNERS / LIGHTING DESIGN RAMA MENDELSON





# What if there is only one?

## **One for All.**

Entero is a set of lighting tools enabling architects and designers to create discrete but diverse lighting schemes, using only one luminaire type throughout the entire project.

Any project. Retail, residential, public, hospitality, art...

Any need. Any size. Anywhere.

It is the most complete family, created to excel in any environment.

## **Inside / Outside.**

Entero is engineered to perfection, both for interior and exterior applications. It enables architects and designers to achieve style continuity throughout the entire project, applying the same clean sightlines and minimal appearance to damp locations, outside ceilings and cantilevers.

## **Intense Energy.**

Entero was designed as an answer to the energy of creation. Crafted to add value to spaces and experiences, bringing intensity to lighting schemes. A fusion of power and elegance, comfort and precision. One single range of luminaires to illuminate with power or for atmosphere, from low and high.

[www.deltalight.us/entero](http://www.deltalight.us/entero)

[www.deltalight.ca/entero](http://www.deltalight.ca/entero)

**FAMILY OVERVIEW**

**CHOOSE YOUR FINISH**



Black / Gold Colored / White

**CHOOSE YOUR INSTALLATION**

Trim / Trimless  
Adjustable

**CHOOSE YOUR SHAPE**



Round / Square  
Small / Medium / Large

**CHOOSE YOUR POWER**

Small 3,9W up to 12,4W – 390 up to 1470lm  
Medium 3,9W up to 25W – 390 up to 2810lm  
Large 3,9W up to 36,5W – 390 up to 4580lm

**CHOOSE YOUR OPTICS**

Small 10° / 20° / 45° / Wallwash  
Medium 10° / 18° / 30° / 45° / Wallwash  
Large 10° / 18° / 30° / 45°

**CHOOSE YOUR APPLICATION**

New Construction  
Remodel

**CHOOSE YOUR CONTROL**

0-10V / Phase Dimming /  
Lutron Eco

**CHOOSE YOUR COLOR TEMPERATURE**

2700K / 3000K / 3500K / Soft Dim / Tunable White

**CHOOSE YOUR ACCESSORY**

Honeycomb / Glass SBL / Linear Spread Lens /  
Softening Lens / Spread Lens



Ø84mm  
Ø3'-5/16

93mm  
4'-10/16



Ø100mm  
Ø3'-15/16

122mm  
4'-13/16



Ø122mm  
Ø4'-13/16

150mm  
5'-15/16



84mm  
3'-5/16

93mm  
4'-10/16

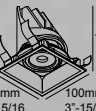

100mm  
3'-15/16

122mm  
4'-13/16

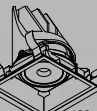

122mm  
4'-13/16

150mm  
5'-15/16

# Interior

Find the other members of this family **EXTERIOR CEILING**









# SNEAK-R

A wallwash light effect can upgrade any project, adding sophistication and emphasizing detail in interior design. Sneak-R is a top-notch wallwash range in Delta Light's collection, allowing the user to create depth in a room via an evenly illuminated wall. With Sneak-R you can reduce the contrast between a well-lit workspace and its environment, or it gives your artwork the perfect light it deserves.

Engineered to perfection, the Sneak-R combines a slightly curved cover with a lens, resulting in an evenly lit wall, from floor to ceiling. Thanks to the design harmony between led and lens, Sneak-R can be kept very compact and does not attract any attention to the luminaire. The cover design reduces the angle of the mechanical cut-off, resulting in a minimum of glare and a maximum of visual comfort.

[www.deltalight.us/sneak-r](http://www.deltalight.us/sneak-r)  
[www.deltalight.ca/sneak-r](http://www.deltalight.ca/sneak-r)



## FAMILY OVERVIEW

### CHOOSE YOUR FINISH



Silver Grey / White

### CHOOSE YOUR INSTALLATION

Trimless / Trim

### POWER

11,3W – 1630lm

### CHOOSE YOUR COLOR TEMPERATURE

2700K / 3000K / 3500K

### CHOOSE YOUR APPLICATION

New Construction  
Remodel

### CHOOSE YOUR CONTROL

0-10V / Phase Dimming /  
Lutron Eco / Lutron 2-Wire

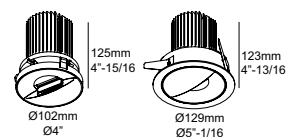



ARCHITECTS DTR STUDIO - LIGHTING DESIGN - BIG ARCHITECTURAL LIGHTING - PHOTO CRIS BELTRAN





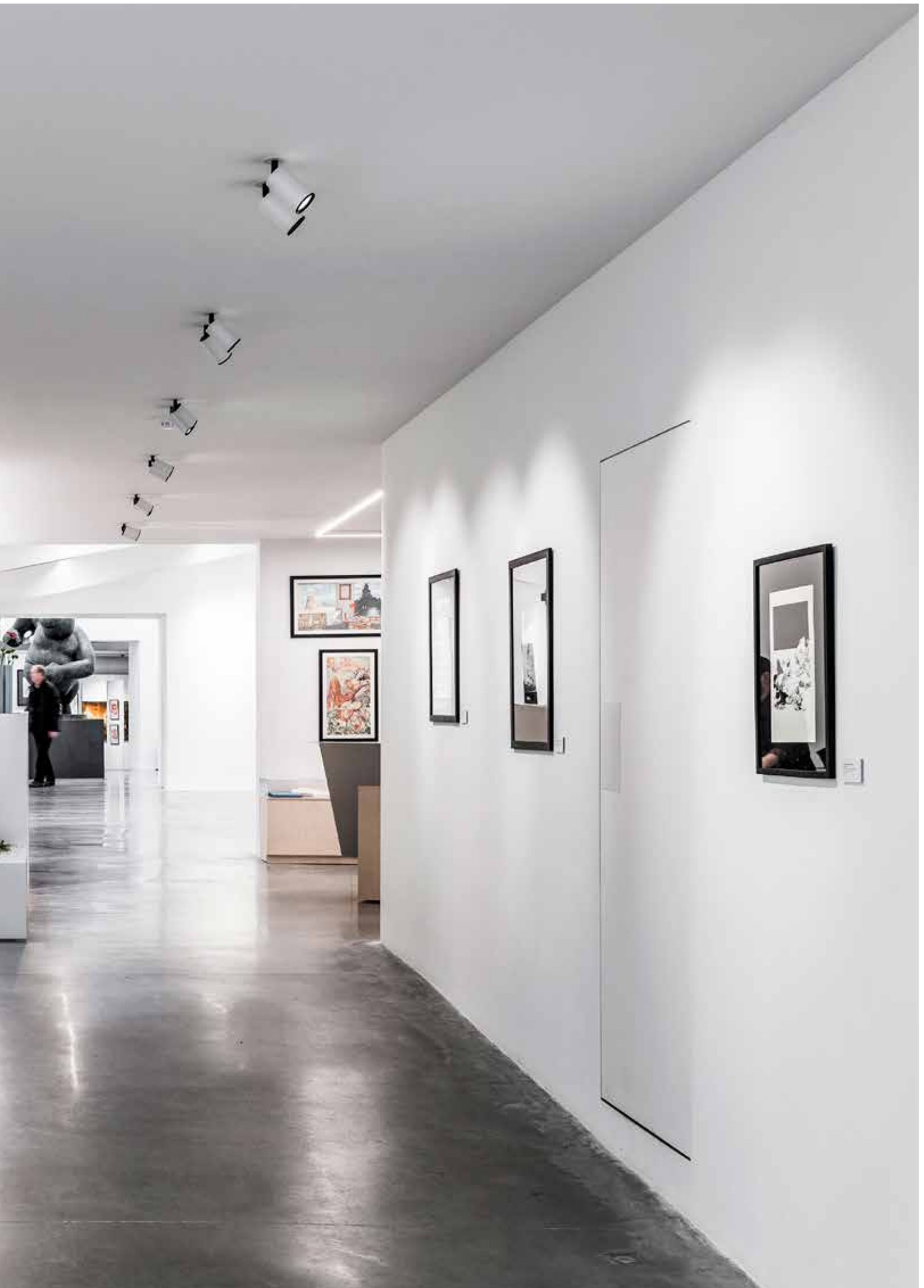

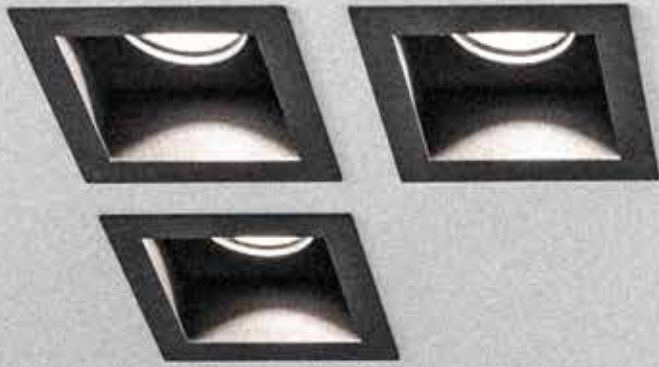

# CARREE

## FAMILY

The Carree range is Delta Light's answer for easy-to-install, timeless and functional recessed spots, as it has been a Delta Light classic for many years. This family of square recessed luminaires offers refined solutions for LED or halogen, either with or without trim. The straight lines in the design make a contemporary spot out of Carree, not only useful in modern architecture but also in many other applications.

Carree can be used throughout the entire project, as it also includes IP44 solutions for bathrooms and even IP65 luminaires for outdoor use.

[www.deltalight.us/carree](http://www.deltalight.us/carree)  
[www.deltalight.ca/carree](http://www.deltalight.ca/carree)





**FAMILY OVERVIEW**

**CHOOSE YOUR FINISH**



Alu Grey / Black / White



Black-Gold Matt / White-Black combination

**CHOOSE YOUR INSTALLATION**

Trimless / Trim

Indoor / Outdoor

**CHOOSE YOUR POWER**

10,4W up to 15W - 1075 up to 1446lm

**OPTICS**

33°

**CHOOSE YOUR APPLICATION**

New Construction

Remodel

**CHOOSE YOUR CONTROL**

0-10V / Phase Dimming /

Lutron Eco

**CHOOSE YOUR COLOR TEMPERATURE**

2700K / 3000K / 3500K / Soft Dim

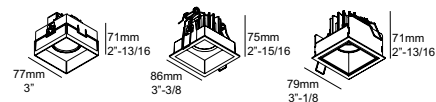





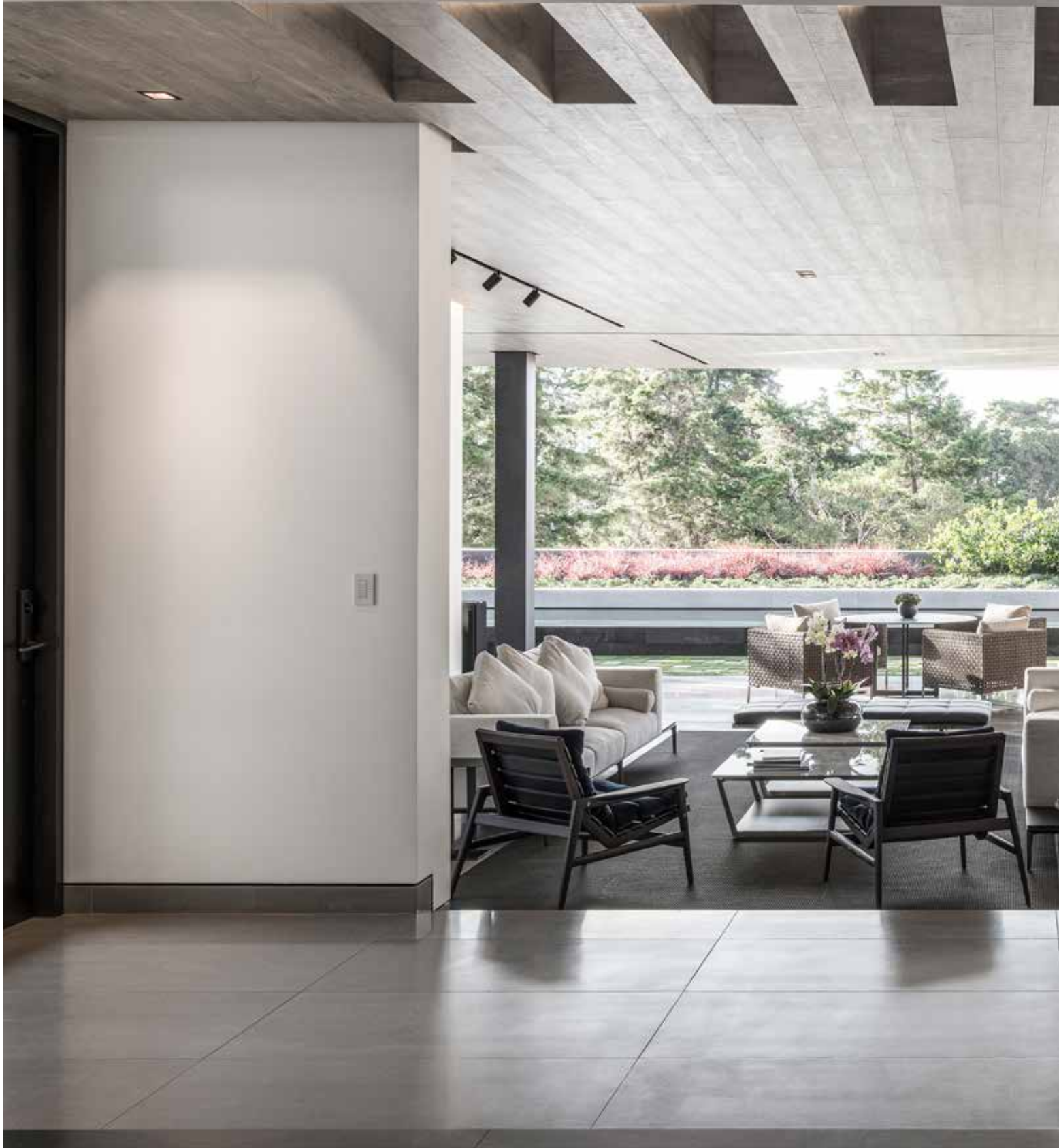

ARCHITECT ALFREDO SARAVIA - AS ARQUITECTURA



ARCHITECTS GOVAERT & VANHOUTTE



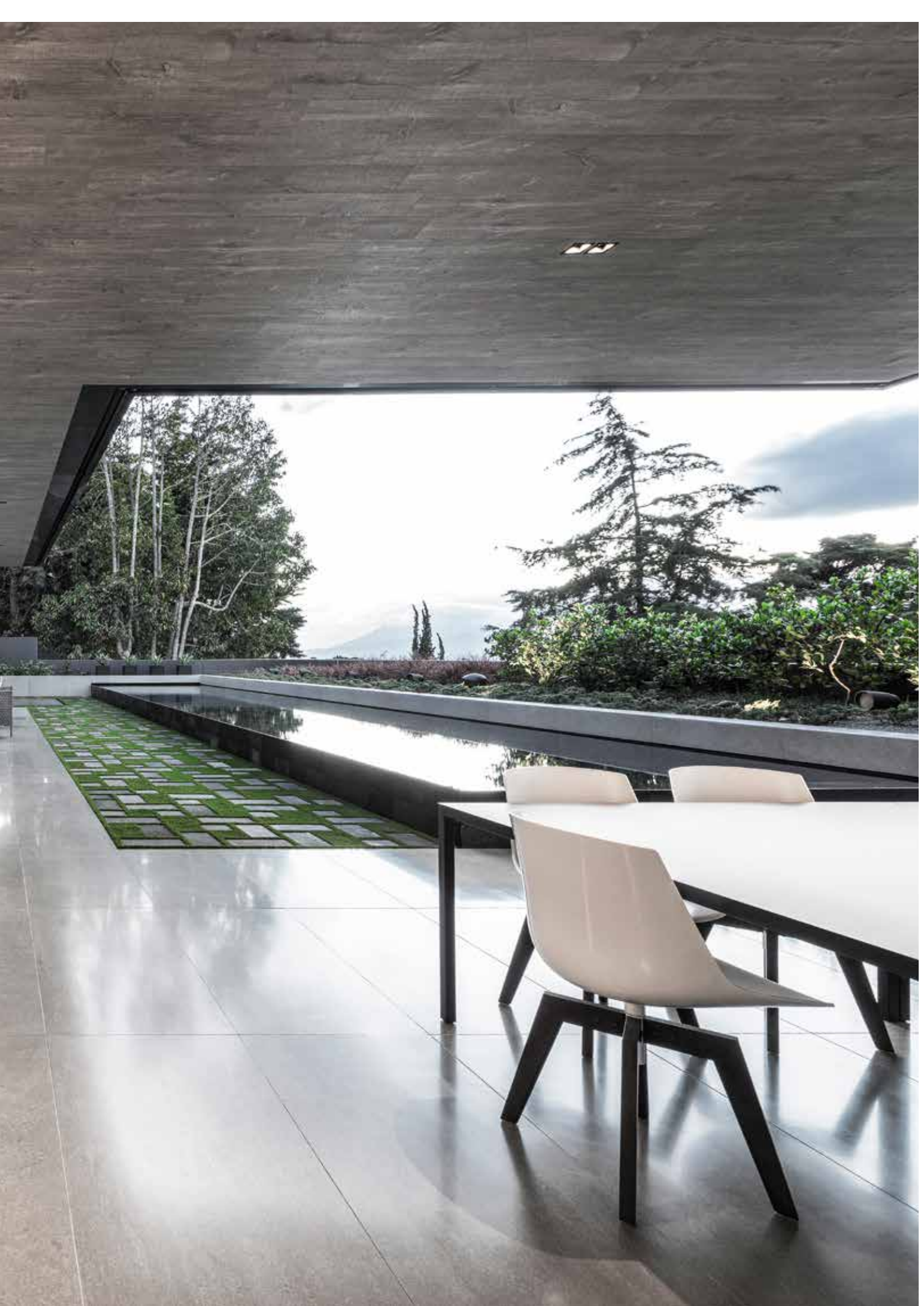



# REO

## FAMILY

The Reo collection is more than one product, it is a family which offers a solution for many lighting demands, from residential to hotel, restaurant to retail and much more. In line with this philosophy, Reo comes in single and double fixtures, round or square, orientable or fixed, in multiple finishing colors, for both indoor and outdoor use.

The design of these recessed conical spots delivers a hardly visible transition from the intense light to the ceiling, resulting in a halo-like effect, ideal to give the space an extra dimension.

### **MINI REO**

Mini Reo offers a multitude of lighting solutions, as it combines multiple beam angles in both non-adjustable and adjustable luminaires. Spot, Medium or Flood can be combined to fit the specific needs of the project.

### **REO**

Similar to Mini Reo, Reo offers adjustable and non-adjustable downlights in multiple beam angles. With an output up to 15W, Reo can easily be integrated into hospitality and residential projects, especially when using the Soft Dim version which creates a warm and cosy atmosphere when dimming down the luminaire. Reo comes in a round and square design. Within the round design one can opt for a smooth finishing of the inner cone or choose the ribbed version that reduces the glare thanks to its cascading transition from light source to ceiling.

[www.deltalight.us/reo](http://www.deltalight.us/reo)  
[www.deltalight.ca/reo](http://www.deltalight.ca/reo)



**INTERIOR CEILING**

Find the other members of this family **EXTERIOR CEILING**





**FAMILY OVERVIEW**

**CHOOSE YOUR FINISH**



Black / Flemish Bronze / Flemish Gold / White

**CHOOSE YOUR SHAPE & SIZE**



Mini Reo / Fix or adjustable

Reo / Fix or adjustable

Reo Square / Adjustable / Single or double

**CHOOSE YOUR POWER**

Mini

6W - 560lm

Reo

10,4W up to 15W - 1075 up to 1446lm

**CHOOSE YOUR COLOR TEMPERATURE**

2700K / 3000K / 3500K / Soft Dim

**CHOOSE YOUR IP-RATING**

IP20 / IP44

**CHOOSE YOUR OPTICS**

Mini

18° / 25° / 37°

Reo

33° / 50°

**CHOOSE YOUR APPLICATION**

Mini

New Construction  
Remote Power Supply

Reo

New Construction  
Remodel

**CHOOSE YOUR CONTROL**

0-10V / Phase Dimming /  
Lutron Eco / Lutron 2-Wire

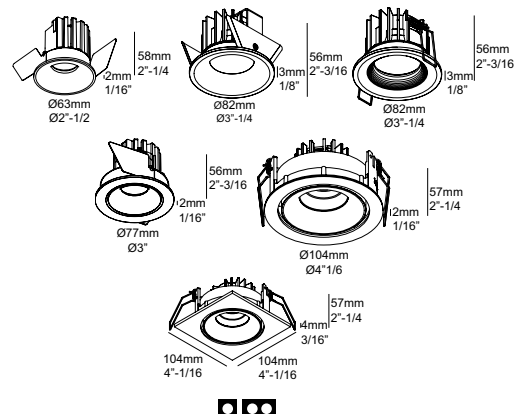

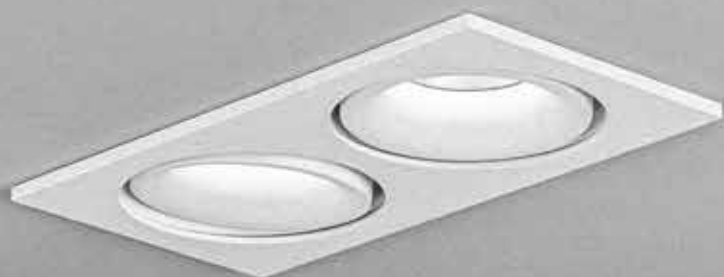

















# ARTUUR

Everything about Artuur catches the eye, be it its design, its optical compartment or its small protrusion when installed into the ceiling. Artuur comes as a downlight with sloping edges towards the center, both round and square. The design twist is in the asymmetrical square version, easily deceiving the eye but inspiring you to present creative layouts.

Another design element is the sophisticated lens on top of the deeply placed LED. While offering an outstanding quality of light, its remarkable aesthetics wow you, even when Artuur is not turned on.

Additionally, Artuur can combine pleasant general lighting with uniform wall washing, as a secondary LED module softly throws its light on vertical surfaces.

When installed into the ceiling, Artuur adds depth into the room owing to its gentle protruding ring. Small enough to be noticed, big enough to make a difference. Put the complete luminaire into a recessing kit and Artuur goes from protruding to trimless, refinement at best!

[www.deltalight.us/artuur](http://www.deltalight.us/artuur)  
[www.deltalight.ca/artuur](http://www.deltalight.ca/artuur)

**FAMILY OVERVIEW**

**CHOOSE YOUR FINISH**



Black / Gold Colored / White

**CHOOSE YOUR INSTALLATION**

With trim / Trimless

**CHOOSE YOUR SHAPE**

Round / Square

**CHOOSE YOUR LIGHT EFFECT**

General light  
General & Wallwash light

**POWER**

8,6W – 1090lm

**CHOOSE YOUR COLOR TEMPERATURE**

2700K / 3000K / 3500K / Soft Dim

**CHOOSE YOUR OPTICS**

30° / 60° / Linear spread

**CHOOSE YOUR APPLICATION**

New Construction  
Remodel

**CHOOSE YOUR CONTROL**

0-10V / Phase Dimming / Lutron Eco

IP20

IP44

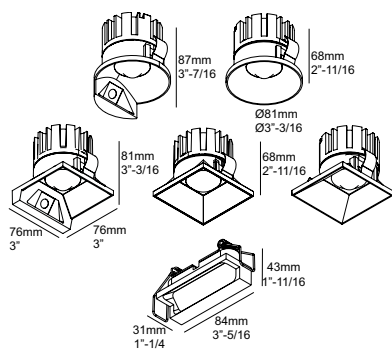



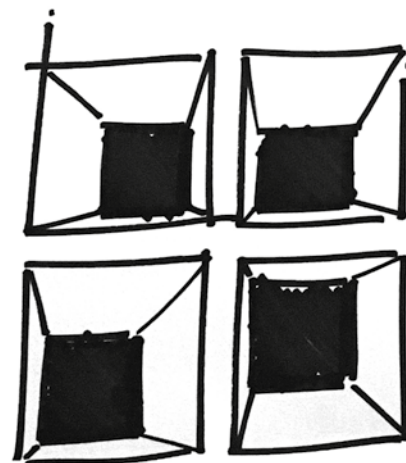
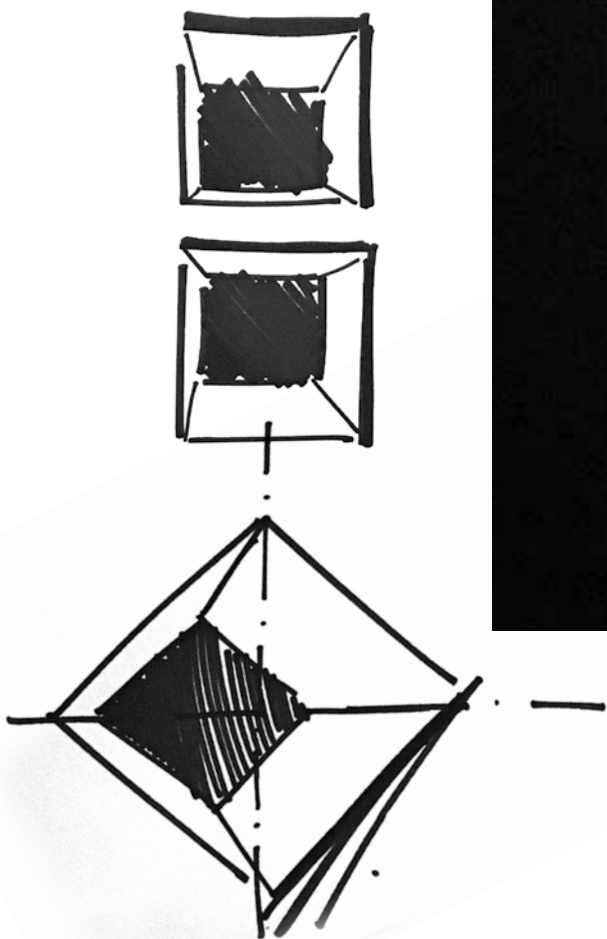









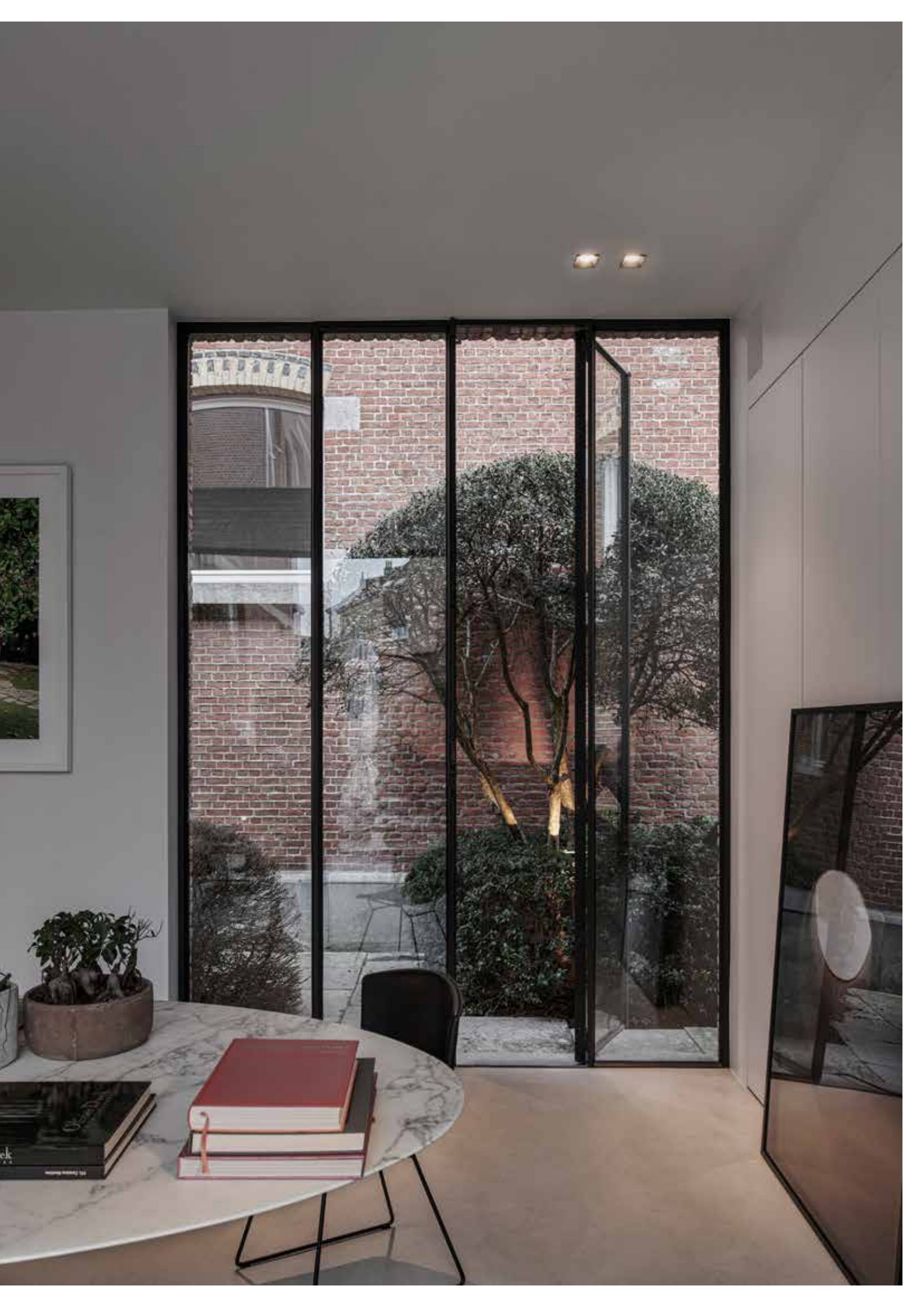

# DEEP RINGO FAMILY

The conical shaped design of the Deep Ringo fixtures and its deeper placed LED source make sure that glare is reduced to a minimum when Deep Ringo is installed in the ceiling. The small trim gives a refined touch to this elegant luminaire.

Available in 3 sizes, with trim or trimless, fix or adjustable, a range of beam angles and multiple finishing colors, Deep Ringo is an easy-to-use downlight throughout the project. Its golden or bronze finish is perfect to add a sniff of luxury to the room.

## **MINI DEEP RINGO**

Mini Deep Ringo is playful, as it comes in a multitude of finishing colors, has 3 different beam angles to choose from and can be fix or adjustable. A range of possibilities in a slender design.

## **DEEP RINGO**

Deep Ringo is the most elaborate of the family, offering LED and halogen solutions, for use in both dry and wet areas. Similar as the Reo family, Deep Ringo also offers a ribbed version that reduces the glare thanks to its cascading transition from light source to ceiling.

[www.deltalight.us/deep-ringo](http://www.deltalight.us/deep-ringo)  
[www.deltalight.ca/deep-ringo](http://www.deltalight.ca/deep-ringo)



INTERIOR CEILING

Find the other members of this family **EXTERIOR CEILING**





**FAMILY OVERVIEW**

**CHOOSE YOUR FINISH**



Black / Flemish Bronze /  
Flemish Gold / Gold Colored / White

**CHOOSE YOUR SIZE & FINISH**

Mini Deep Ringo / Fix & Adjustable

Deep Ringo / Fix & Adjustable  
/ Trim & Trimless

**CHOOSE YOUR POWER**

Mini Deep Ringo  
9W - 1080lm

Deep Ringo  
10,4W up to 15W - 1075 up to 1446lm

**CHOOSE YOUR COLOR TEMPERATURE**

2700K / 3000K / 3500K / Soft Dim

**CHOOSE YOUR OPTICS**

Mini Deep Ringo / 18° / 25° / 37°  
Deep Ringo / 33°

**CHOOSE YOUR APPLICATION**

Mini Deep Ringo  
New Construction  
Remote Power Supply

Deep Ringo  
New Construction  
Remodel

**CHOOSE YOUR CONTROL**

0-10V / Phase Dimming / Lutron Eco / Lutron 2-Wire

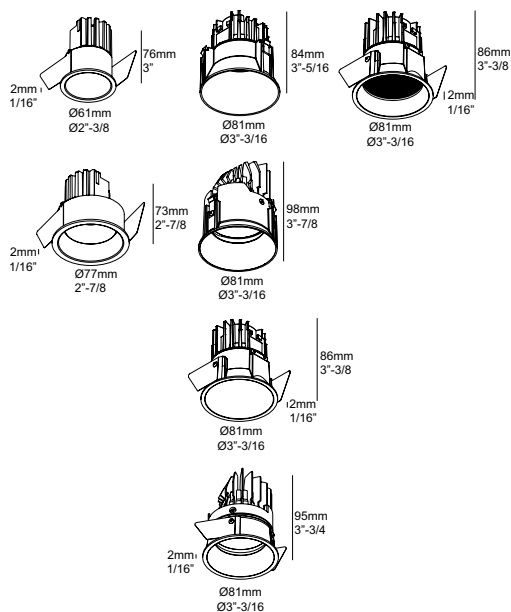





INTERIOR DESIGN MAISTER / PHOTOGRAPHY BERT DEMASURE



INTERIOR DESIGN LICUA DESIGN - LIGHTING DESIGN BIG ARCHITECTURAL LIGHTING - PHOTO JUANAN BARROS









Partou fits in everywhere.

# PARTOU

Partou? Oui oui! The Partou family has countless application possibilities, as it combines round and square shapes, fix and adjustable luminaires and offers an IP44 protection rate from below. Easy to fit in everywhere – partout in French -, from residential to hospitality, from dining room to bathroom.

[www.deltalight.us/partou](http://www.deltalight.us/partou)  
[www.deltalight.ca/partou](http://www.deltalight.ca/partou)

**ADAPTIVE DESIGN**

The clever design of Partou offers a multitude of finishing options on 1 and the same LED module. Complete your LED module with the cover you want: round or square, small or bigger, white or black.



**FAMILY OVERVIEW**

**CHOOSE YOUR FINISH**



Black / White

**CHOOSE YOUR SHAPE & SIZE**



Mini Partou

Partou

Fix or adjustable

Partou Square

**POWER**

9W - 1080lm

**CHOOSE YOUR COLOR TEMPERATURE**

2700K / 3000K / 3500K

**CHOOSE YOUR OPTICS**

18° / 25° / 37°

**CHOOSE YOUR APPLICATION**

New Construction

Remodel

**CHOOSE YOUR CONTROL**

0-10V / Phase Dimming / Lutron Eco

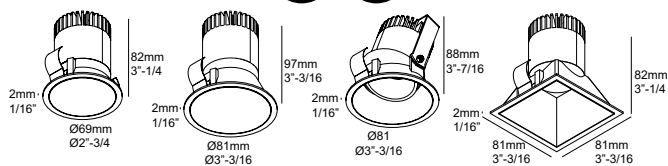





# GRID

The Grid product family is a longstanding classic in the collection. First as halogen and discharge solutions, later as LED downlight and afterwards updated to the Snap-In principle, a smart and easy way of separating the mounting frame from the LED module, with comfortable installation as a result. This grid range is all about flexibility, as the single or double light units can be directed any way you want.

## **MICROGRID IN**

Microgrid In completes the Snap-In range as it uses a similar principle of dividing the light unit into a mounting frame and a light module that can be snapped into the frame after installation. Microgrid comes in single, double and triple set-ups with trim.

A visor is available to further reduce the impact of the intense light coming from the miniature light source, shielding the light source from directly looking into.

## **MINIGRID IN ZB**

The ZB principle stands for clean lines and minimalist design. These luminaires can be built into a cove in the ceiling or an optional box can be used as easy installation frame.

## **SNAP/IN**

The Snap-In principle equals modularity and flexibility at its best, it grants the opportunity to the lighting designer to use his creativity: combine single and double units, use multiple beam angles or play with color. All to use as surface mounted luminaire or as recessed spotlights, both with or without trim.

Dividing a luminaire into multiple modular parts not only creates uniformity within one family, it also facilitates the installation by giving the opportunity to the installer to place the frame in advance. No need to worry for the lighting modules in further finishing of the room, as the modules can be clicked into the frame afterwards.

## **GRID IN**

The classic from the range offering AR-111 solution for halogen.









FAMILY OVERVIEW

**MICROGRID SNAP-IN**

**CHOOSE YOUR FINISH**



**CHOOSE YOUR SHAPE**



**INSTALLATION**

Recessed  
With trim

**POWER**

3,9W – 520lm

**CHOOSE YOUR COLOR TEMPERATURE**

2700K / 3000K / 3500K

**CHOOSE YOUR OPTICS**

15° / 30°

**CHOOSE YOUR APPLICATION**

New Construction  
Remote Power Supply

**CHOOSE YOUR CONTROL**

0-10V / Phase Dimming /  
Lutron Eco

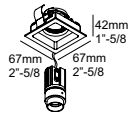

**MINIGRID SNAP-IN  
MINIGRID 67 SNAP-IN**

**CHOOSE YOUR FINISH**



**CHOOSE YOUR SHAPE**



**CHOOSE YOUR INSTALLATION**

Recessed  
With trim / Trimless

Surface mounted

**CHOOSE YOUR POWER**

8W up to 23,2W -  
980lm up to 3170lm

**CHOOSE YOUR COLOR TEMPERATURE**

2700K / 3000K / 3500K / Soft Dim

**CHOOSE YOUR OPTICS**

Minigrid  
6° / 18° / 25° / 33° / 37° / 50°

Minigrid HP  
20° / 37° / 50°

**CHOOSE YOUR APPLICATION**

New Construction

**CHOOSE YOUR CONTROL**

0-10V / Phase Dimming /  
Lutron Eco

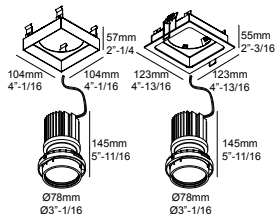
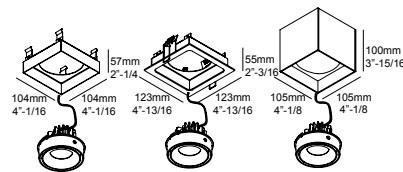
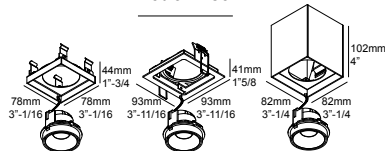

**MINIGRID ZB**

**CHOOSE YOUR FINISH**



**CHOOSE YOUR SHAPE**



**INSTALLATION**

Recessed  
Trimless

**POWER**

7,1W – 810lm

**CHOOSE YOUR COLOR TEMPERATURE**

2700K / 3000K / 3500K

**OPTICS**

33°

**CHOOSE YOUR APPLICATION**

New Construction

**CHOOSE YOUR CONTROL**

0-10V

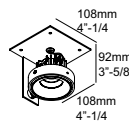

**GRID**

**CHOOSE YOUR FINISH**

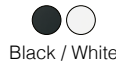

**CHOOSE YOUR SHAPE**



**INSTALLATION**

Recessed  
Trimless

**LIGHT SOURCE**

G53

**CHOOSE YOUR APPLICATION**

New Construction

**CHOOSE YOUR CONTROL**

Phase Dimming

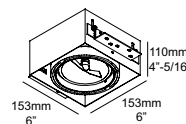

[www.deltalight.us/microgrid](http://www.deltalight.us/microgrid)  
[www.deltalight.ca/microgrid](http://www.deltalight.ca/microgrid)

[www.deltalight.us/minigrid](http://www.deltalight.us/minigrid)  
[www.deltalight.ca/minigrid](http://www.deltalight.ca/minigrid)

[www.deltalight.us/minigrid](http://www.deltalight.us/minigrid)  
[www.deltalight.ca/minigrid](http://www.deltalight.ca/minigrid)

[www.deltalight.us/grid](http://www.deltalight.us/grid)  
[www.deltalight.ca/grid](http://www.deltalight.ca/grid)





ate 1



Exit



Exit



ERIBO / INTERIEURBURO PEDRO VERHUE





WWW.ABCPROJECTS.BE



ARCHITECTS GOVAERT & VANHOUTTE

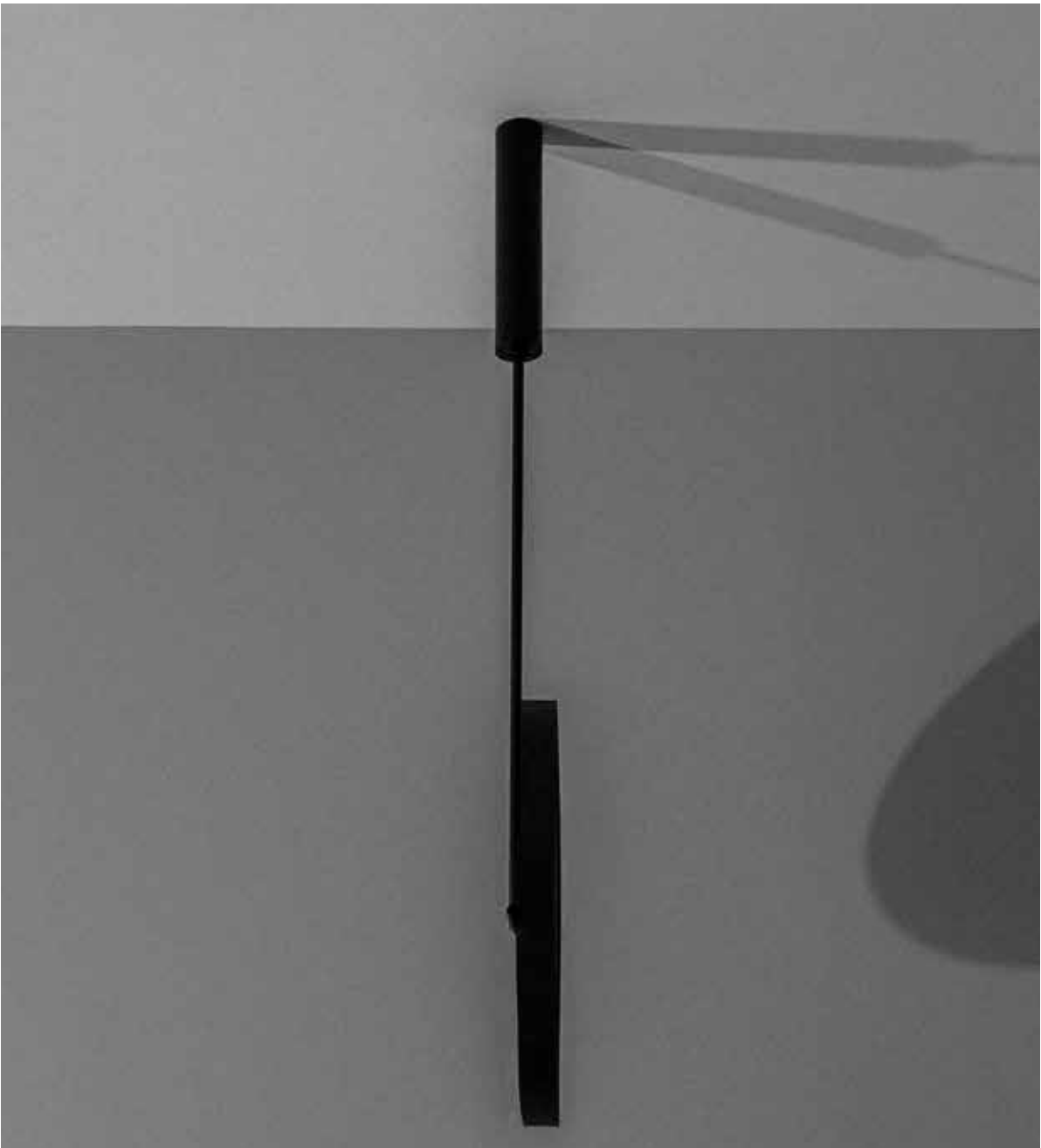

# MULTINOVA

## FAMILY

Multinova has something familiar and something fresh at the same time. As a disc of light, Nova refers to the Supernova range, as both families share similarities in looks and ways of installation. But Multinova has some additional features to make it multi-applicable, hence Multi in the name.

With 2 different diameters, a down and down-up version and a limited height of only 2"-3/4 - 69mm, Multinova is perfect to use in different ways. Its small dimensions fit in any residential or hospitality project, as a track mounted luminaire it suits any retail environment and with a prismatic sheet for reduced glare it even adapts in office settings. Moreover, Multinova can be used on our Magnetic profiles for general lighting.

Multinova comes in our standard black or white and can also be finished in the warmer Gold Colored to enrich its surroundings. To top it off – next to a sandblasted or prismatic optic – one can opt for a smoked sheet at the front for a more decorative touch. When turned on the disc is fully lit, when turned off a deep dark arises, ideal in combination with a Gold Colored Multinova.

[www.deltalight.us/multinova](http://www.deltalight.us/multinova)  
[www.deltalight.ca/multinova](http://www.deltalight.ca/multinova)





**FAMILY OVERVIEW**

**CHOOSE YOUR FINISH**



Black / Gold Colored / White

**CHOOSE YOUR INSTALLATION**

Recessed

Surface mounted

Fix / Pivot

Suspended

Fix / Pivot

Cable / Rod

**CHOOSE YOUR LIGHT EFFECT**

Down / Down-Up

**CHOOSE YOUR SIZE & POWER**

Ø11"-13/16 - 300mm

Down 9,4W up to 14,8W – 1370 up to 2150lm

Down-Up 12,1W up to 18,8W– 1760 up to 2730lm

Ø21"-5/8 - 550mm

Down 33,2W – 4820lm

Down-Up 38,5W – 5590lm

**CHOOSE YOUR COLOR TEMPERATURE**

3000K / 3500K / Soft Dim / Tunable White

**CHOOSE YOUR OPTICS**

Sandblasted / Prismatic (UGR<19) / Smoke

**CHOOSE YOUR CONTROL**

Non Dim / 0-10V / DALI Dim / Lutron Eco

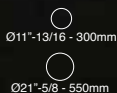

Ø60mm  
Ø2"-3/8

302mm  
11"-7/8

Ø15mm  
Ø9/16"

400mm  
15"-3/4

47mm  
1"-7/8

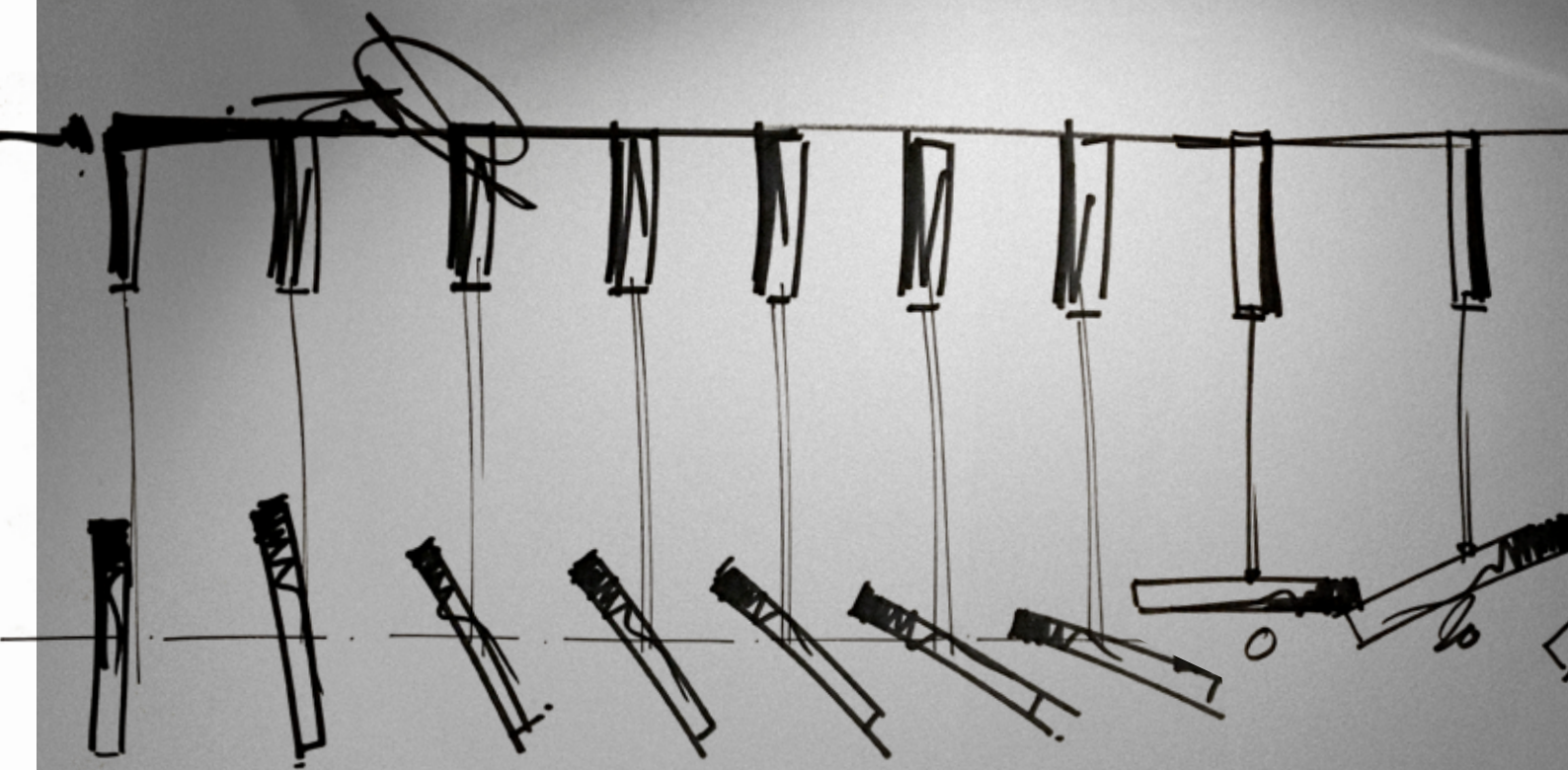
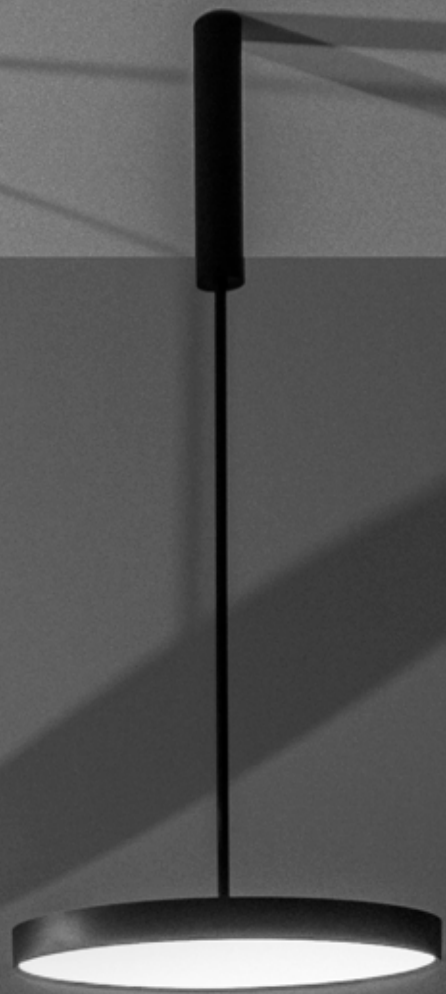
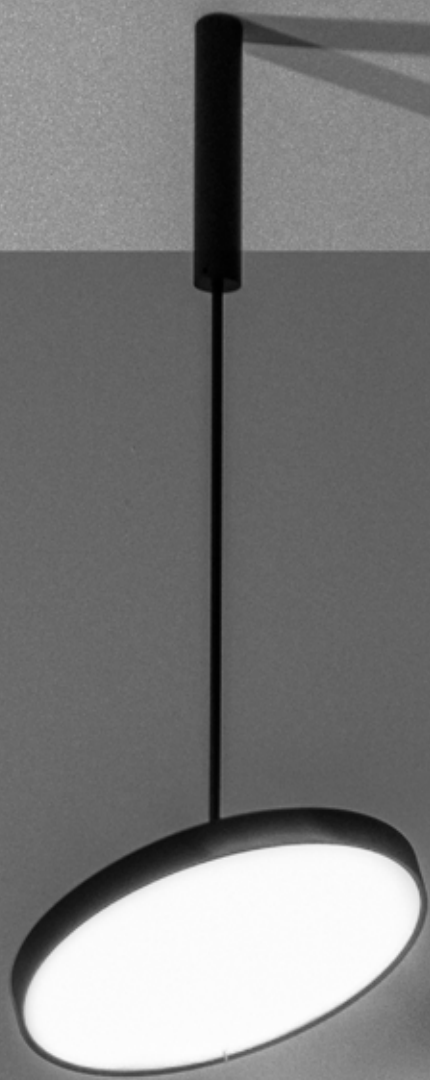

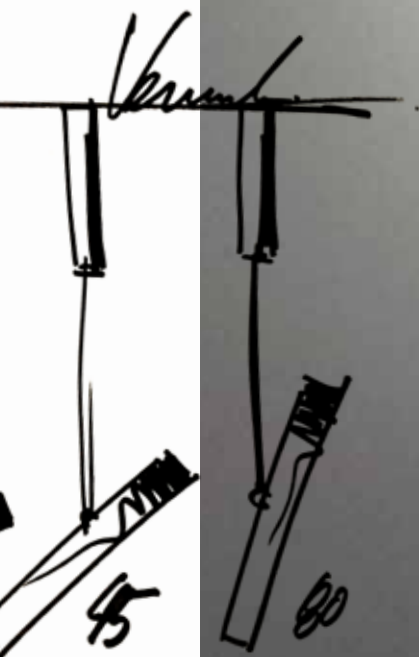

**FLIP ME, I'M MADE FOR IT**

Apart from the recessed, surface mounted and track version, there are two ways to suspend Multinova. Suspended by cables Multinova faces straight downwards, but as a rod suspension Multinova can be tilted up to 90° to face vertical surfaces as well. As such, one single suspension can dress up any room while a cluster of these serve to create frisky light settings.





STUDIO DIDEA

interior  
innovation  
award  
Winner



reddot design award  
winner

GOOD  
DESIGN  
award

—AWARD—  
DESIGN PLUS  
light+building



# SUPERNOVA

## FAMILY

Supernova is an extensive range of pure geometrically formed lighting fixtures that guarantee powerful illumination and atmosphere. The range comes in different diameters and application possibilities.

Supernova features in-house developed printed circuit boards specifically engineered to provide a uniform illumination of the polycarbonate. Small to large, recessed to suspended, for general lighting to office applications, the Supernova range features all you need.



**SUPERNOVA XS**

With its 10" - 26cm or 13" - 33cm diameter, the Supernova XS (Extra Small) can be considered to be the baby in the range when it comes to size, but not when it comes to performance and skills. It only needs 2"-3/8" - 6cm of height to hide away an intense cluster of powerleds in its perfectly curved aluminium body.

Following its big brother, the recessed Supernova XS is distinguished thanks to its remarkable tilted application when installed into the ceiling, a particular way of changing a simple round downlight into a playful eye-catcher.

[www.deltalight.us/supernova-xs](http://www.deltalight.us/supernova-xs)  
[www.deltalight.ca/supernova-xs](http://www.deltalight.ca/supernova-xs)

**SUPERNOVA XS**

**CHOOSE YOUR FINISH**



Black / White

**CHOOSE YOUR INSTALLATION**

Recessed  
 Surface mounted

**CHOOSE YOUR SIZE & POWER**

Diam. 10" 1/4 - 260mm / 13" - 330mm  
 12W up to 22W - 1050lm up to 2600lm

**COLOR TEMPERATURE**

3000K

**CHOOSE YOUR CONTROL**

0-10V Dim / Phase Dimming

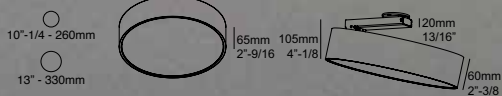



**SUPERNOVA FLAT**

The evolution in LED allowed for a more minimalistic design, visible within Supernova Flat. It combines the Supernova characteristics with a more subtle housing, creating a neat and modern look. Combined with a prismatic cover, Supernova Flat offers a lighting solution suitable for office and school application as its UGR remains below 19. Available for direct or direct-indirect lighting or with a soft uplight accent in Supernova Flat Smooth Up.

[www.deltalight.us/supernova-flat](http://www.deltalight.us/supernova-flat)  
[www.deltalight.ca/supernova-flat](http://www.deltalight.ca/supernova-flat)



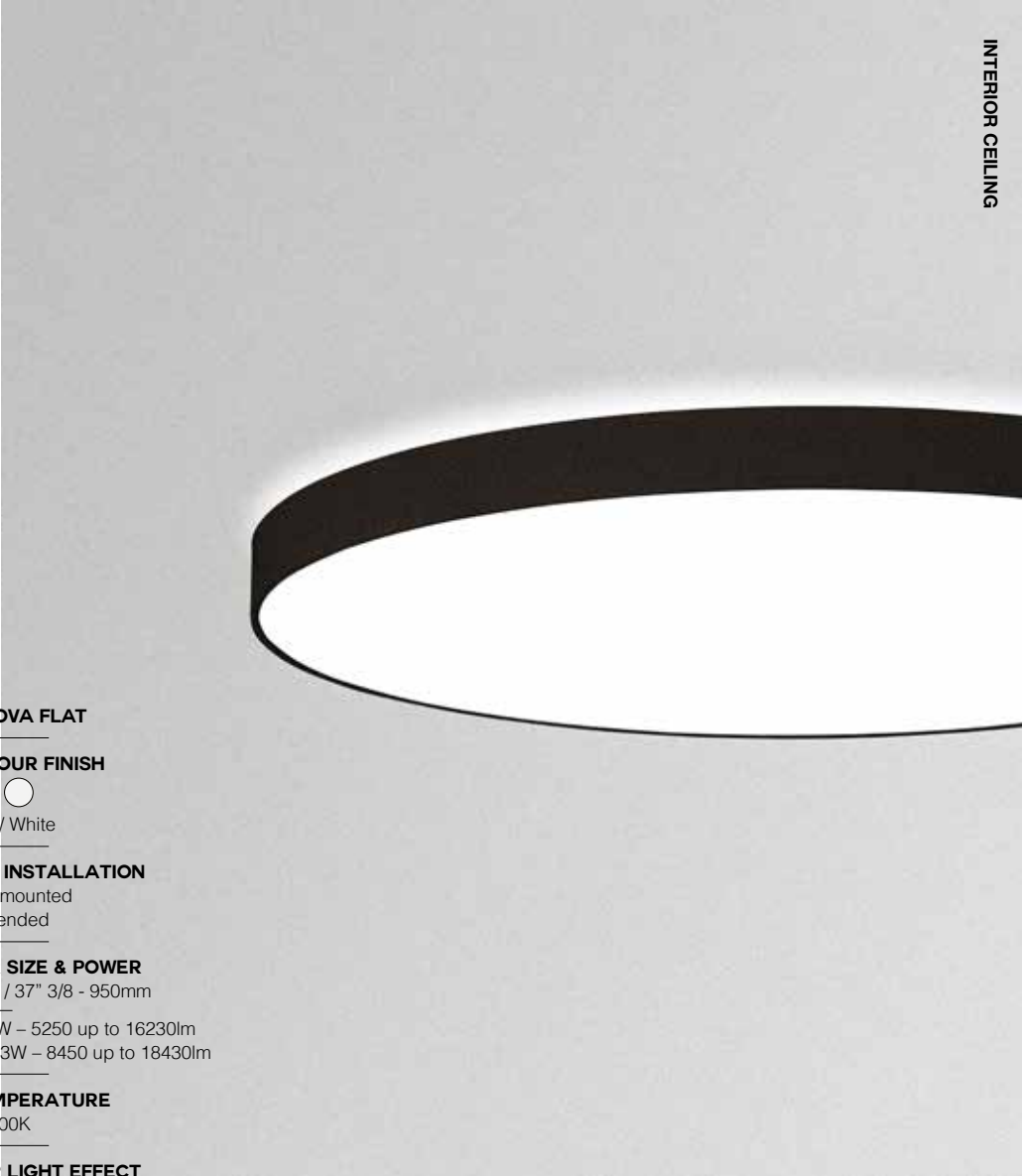

**SUPERNOVA FLAT**

**CHOOSE YOUR FINISH**



Black / White

**CHOOSE YOUR INSTALLATION**

Surface mounted  
Suspended

**CHOOSE YOUR SIZE & POWER**

25" 9/16 - 650mm / 37" 3/8 - 950mm

Down - 40W up to 132W - 5250 up to 16230lm  
Down-Up - 61W up to 153W - 8450 up to 18430lm

**COLOR TEMPERATURE**

3000K

**CHOOSE YOUR LIGHT EFFECT**

Down / Down-Up  
Sandblasted / Prismatic (UGR<19)

**CHOOSE YOUR CONTROL**

0-10V Dim / Lutron Eco

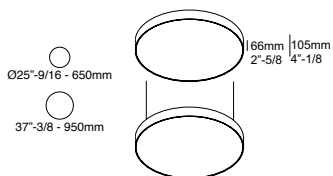



## **SUPERNOVA**

Supernova comes as recessed, surface mounted or suspended luminaire, a wide range of possibilities.

Thanks to its trimless recessed finishing this Supernova Trimless discretely fits into the architecture of the room, with the emphasis on the light rather than the luminaire.

The seamless transition of light to ceiling makes this elegant eye-catcher float above the room, providing a perfectly uniform field of light.

The recessed version is a particularly eye-catching option in the Supernova range, thanks to its tilted application. A recessed kit facilitates installation, allows you to customize the depth and angle of the Supernova, and ensures the inner workings of the fitting are concealed within the ceiling.

Surface mounted, Supernova is a timeless lighting solution that guarantees powerful illumination and striking atmosphere, blending harmonically into its space. Its uninterrupted circular form and neutral character enhance any room, from hotel lobbies to corridors to shops, or any other type of project.

A suspended Supernova uses four delicate steel cords to enable an easy suspension. The down-up version features a polycarbonate on top to avoid dust entering the fixture and guaranteeing a pleasant and an immaculate indirect light effect. Thanks to the transparent supply cable and the trimless suspension kit you can opt for a very clean and minimalistic ceiling suspension.

[www.deltalight.us/supernova](http://www.deltalight.us/supernova)  
[www.deltalight.ca/supernova](http://www.deltalight.ca/supernova)

**SUPERNOVA**

**CHOOSE YOUR FINISH**



Black / White

**CHOOSE YOUR INSTALLATION**

- Recessed
- Surface mounted
- Suspended

**CHOOSE YOUR SIZE & POWER**

Ø 17"-3/4 - 450mm / 29"-9/16 - 650mm /  
37"-3/8 - 950mm / 47"-3/16 - 1250mm

Down - 45W up to 240W - 7230lm up to 36800lm  
Down-Up - 75W up to 285W - 11500lm up to 43700lm

**CHOOSE YOUR LIGHT EFFECT**

Down / Down-Up

**CHOOSE YOUR COLOR TEMPERATURE**

3000K / 3500K / Tunable White

**CHOOSE YOUR CONTROL**

0-10V Dim / DALI Dim / Lutron Eco

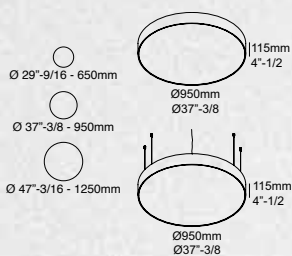



INTERIOR DESIGN PIETER SCHOOLAERT







HUBERTY BREYNE GALLERY



ARCHITECT ASHLEIGH HALLIDAY ARCHITECTS / PHOTOGRAPHY SAM NOONAN





UNDEFEATED

# XY180

XY180 is a 3-piece lighting collection designed by OMA. The collection was inspired by a fascination with point, line and surface; key architectural elements. Ceiling lights are meant for individual and shared workspaces, but can also be applied to domestic and public interior spaces.

The line uses precise geometric dimensions while the base elements - which include tube lights and a spotlight in either a discreet 3,9W or a powerful 7,1W - can be combined with a hinge to generate countless lighting conditions. As individual components, each part is familiar. When assembled however, they can take on unpredictable and asymmetrical positions.

The tube lights create diffuse ambient lighting, while the spotlights provide focused lighting. By exposing the light and allowing it to pivot, the fixture becomes the main feature as it shifts into multiple configurations; a product that contributes to the creation of space, not only by the light it emits, but also by its physical presence.

Design by **OMA** & Delta Light

[www.deltalight.us/xy180](http://www.deltalight.us/xy180)  
[www.deltalight.ca/xy180](http://www.deltalight.ca/xy180)

## FAMILY OVERVIEW

### CHOOSE YOUR FINISH

Black / Black with Punk Finish

### CHOOSE YOUR VERSION

Single or double

Small or large

Tubes for general light /  
Spots for accent light

### CHOOSE YOUR POWER

Tube

8,9W – 1050lm

Spot

3,9W up to 7,1W – 420lm up to 810lm

### CHOOSE YOUR COLOR TEMPERATURE

3000K

### OPTICS

33°

### CHOOSE YOUR CONTROL

0-10V Dim

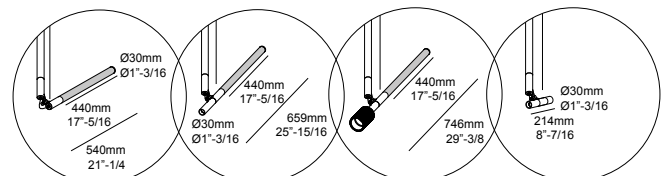
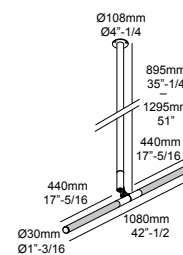



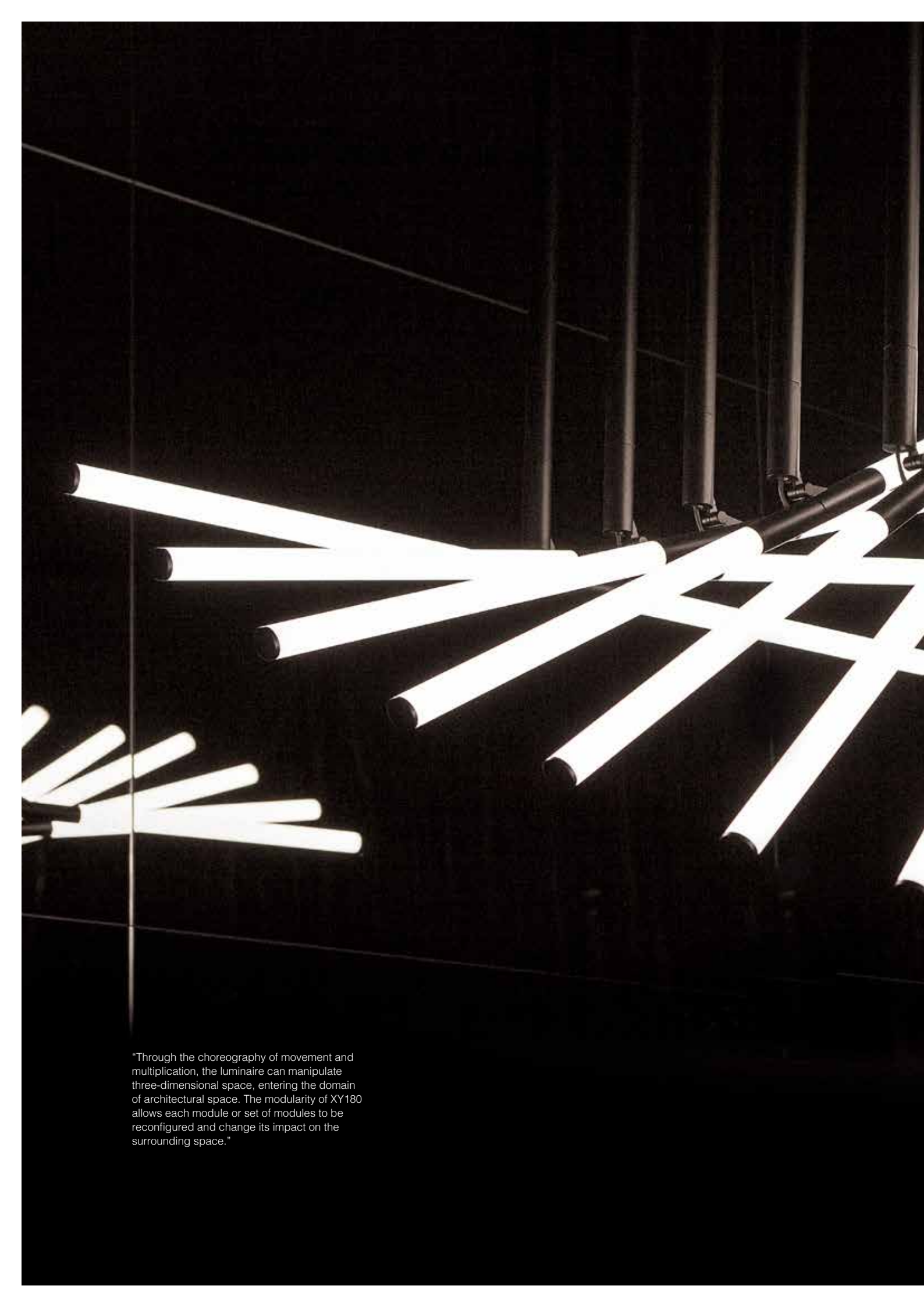

"Through the choreography of movement and multiplication, the luminaire can manipulate three-dimensional space, entering the domain of architectural space. The modularity of XY180 allows each module or set of modules to be reconfigured and change its impact on the surrounding space."



INTERIOR CEILING



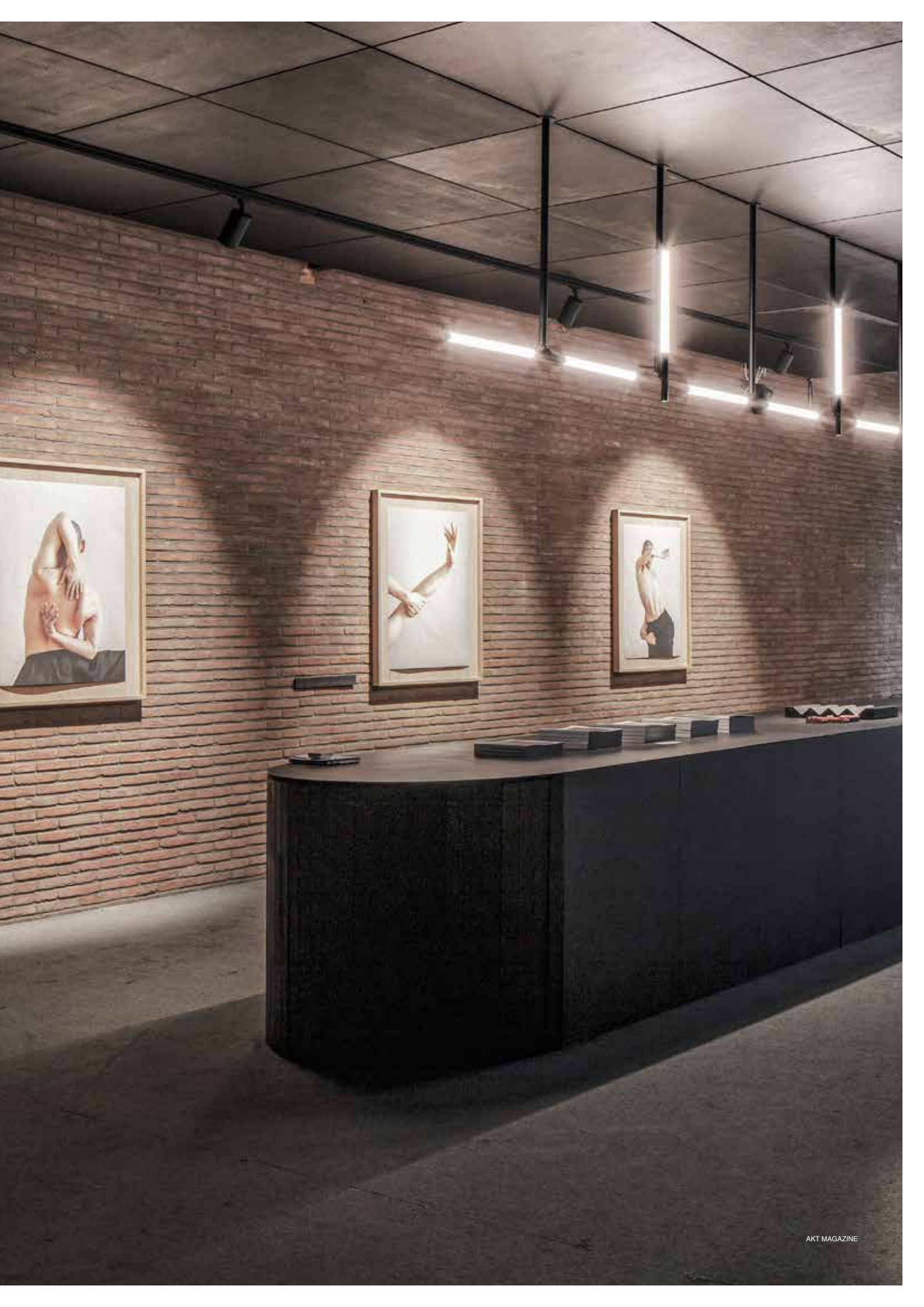

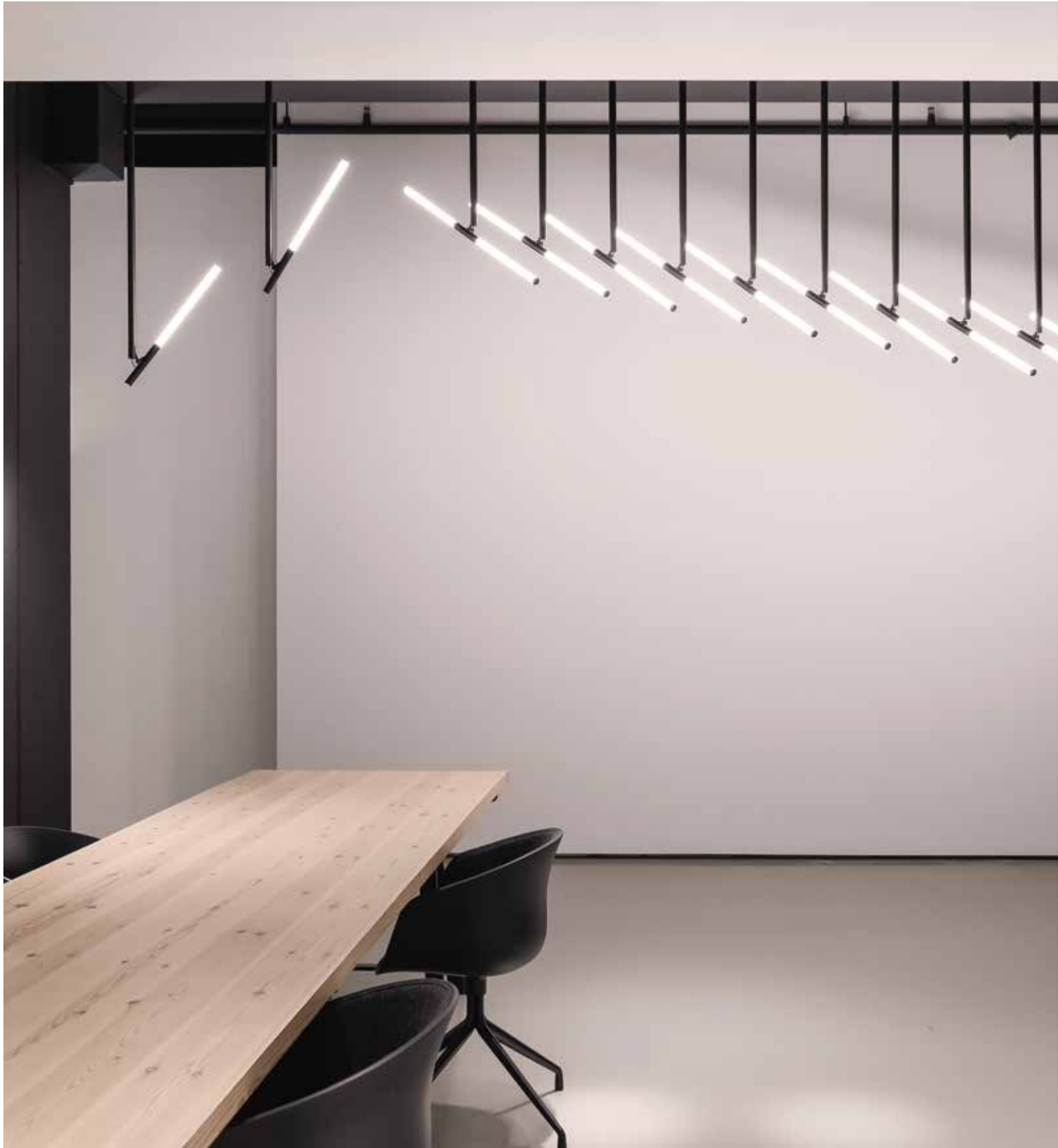





BULTHAUP / PHOTOGRAPHY CAFEINE



# PUNK FAMILY

Step away from brave, alter yourself and dare to dare. This spiked design family breathes creativity and allows you to play with light and texture. To integrate the Punk experience throughout your project, the Punk design is available as pendants, wall luminaires and in the XY180 range. Available in Black, Gold Colored and Black Pure, a Black colored finish with pure aluminum topped spikes.

**PUNK C**

With its particular design, the pendant versions of Punk make a statement on their own, but hanging them in a cluster make them look like a real eye-catcher. Combining different Punk lengths and different finishing colors makes a unique setting out of every Punk cluster.

Design by **OMA & Delta Light**

[www.deltalight.us/punk](http://www.deltalight.us/punk)  
[www.deltalight.ca/punk](http://www.deltalight.ca/punk)



INTERIOR CEILING

Find the other members of this family: INTERIOR WALL / PROFILES

**FAMILY OVERVIEW**

**CHOOSE YOUR FINISH**



Black / Black Pure / Gold Colored

**CHOOSE YOUR INSTALLATION**

Suspended

**CHOOSE YOUR POWER**

6,4W up to 7,1W - 590 up to 810lm

**CHOOSE YOUR COLOR TEMPERATURE**

2700K / 3000K / 3500K

**CHOOSE YOUR OPTICS**

33° / 40°

**CHOOSE YOUR CONTROL**

Phase Dimming

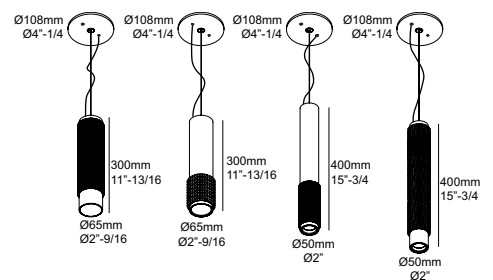









# HEDRA VIZIR

## FAMILY

Vizir and Hedra add refinement, finesse and color to the range. They are characterized by an atypical hinge, a design element that not only catches the eye, but also serves as storage for technical parts inside the luminaire.

Next to black and white, the Vizir and Hedra are available in Gold Colored and Black Bronze finishes, either polished or in faceted texture. The faceted design of the Hedra captures and reflects the ambient light with an ever-changing look a result. It is also the typical design element of the Hedra family, a series of pendant, spotlight and wall mounted luminaires, available as full LED solution or for retrofit bulbs.

[www.deltalight.us/vizir-hedra](http://www.deltalight.us/vizir-hedra)  
[www.deltalight.ca/vizir-hedra](http://www.deltalight.ca/vizir-hedra)





**VIZIR - HEDRA CLIP / ON**

The high-quality finishing on Hedra and Vizir instantly adds a touch of class to the room. The two installation possibilities - surface mounted or semi-recessed - allow to use these directable spotlights in any kind of application. Furthermore, the very slender base with integrated power supply of Vizir and Hedra 2 On bring extra flair and elegance.

**VIZIR - HEDRA C**

The pendants within Vizir and Hedra make you play with light and design. By combining decorative E26 bulbs with integrated LED, short with longer tubes, Vizir and Hedra or Black Bronze finish with Gold Colored, every set-up will be different and unique.



**FAMILY OVERVIEW**

**CHOOSE YOUR FINISH**



Black / Black Bronze / Gold Colored / White

**CHOOSE YOUR INSTALLATION**

Clip

Surface mounted / Single or double

Suspended

**CHOOSE YOUR LIGHT SOURCE & POWER**

LED

3,9W up to 15W - 390 up to 1520lm

E26

**CHOOSE YOUR COLOR TEMPERATURE**

2700K / 3000K / 3500K

**CHOOSE YOUR OPTICS**

Surface 8° / 33°

Suspended 24° / 40°

**CHOOSE YOUR ACCESSORY**

Honeycomb / Lenses

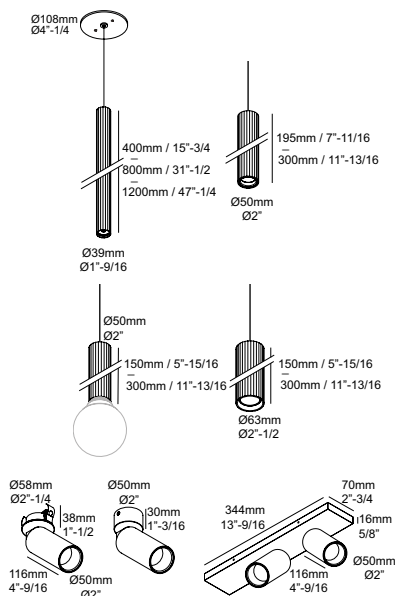





INTERIOR ARCHITECTURE BY @AFC-COLLECTION





ARCHITECT WALL ARCHITECTS / PHOTOGRAPHY ILYA IVANOV



ION





# NEEDLE

The slender shape of the Needle family brings a touch of elegance into any project.

Slim tubes, just carelessly hanging down from the ceiling or cleverly peeking around to throw a highlight wherever needed.

Combine multiple fixtures to create playful clusters or use it as a single luminaire in all its simplicity.

Design by **NITEO LIGHTING** & Delta Light

[www.deltalight.us/needle](http://www.deltalight.us/needle)

[www.deltalight.ca/needle](http://www.deltalight.ca/needle)







**FAMILY OVERVIEW**

**CHOOSE YOUR FINISH**



Flemish Gold / Black Bronze

**CHOOSE YOUR INSTALLATION**

Trimless – Single  
Fix or Adjustable

Surface mounted – Single / Double  
Fix or Adjustable

**CHOOSE YOUR POWER**

3,9W up to 8,2W - 390 up to 680lm

**CHOOSE YOUR COLOR TEMPERATURE**

2700K / 3000K / 3500K

**CHOOSE YOUR OPTICS**

13° / 33°

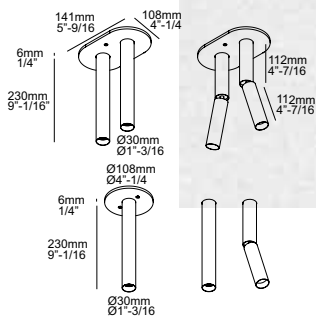



INTERIOR DESIGN PIETER SCHOOLAERT

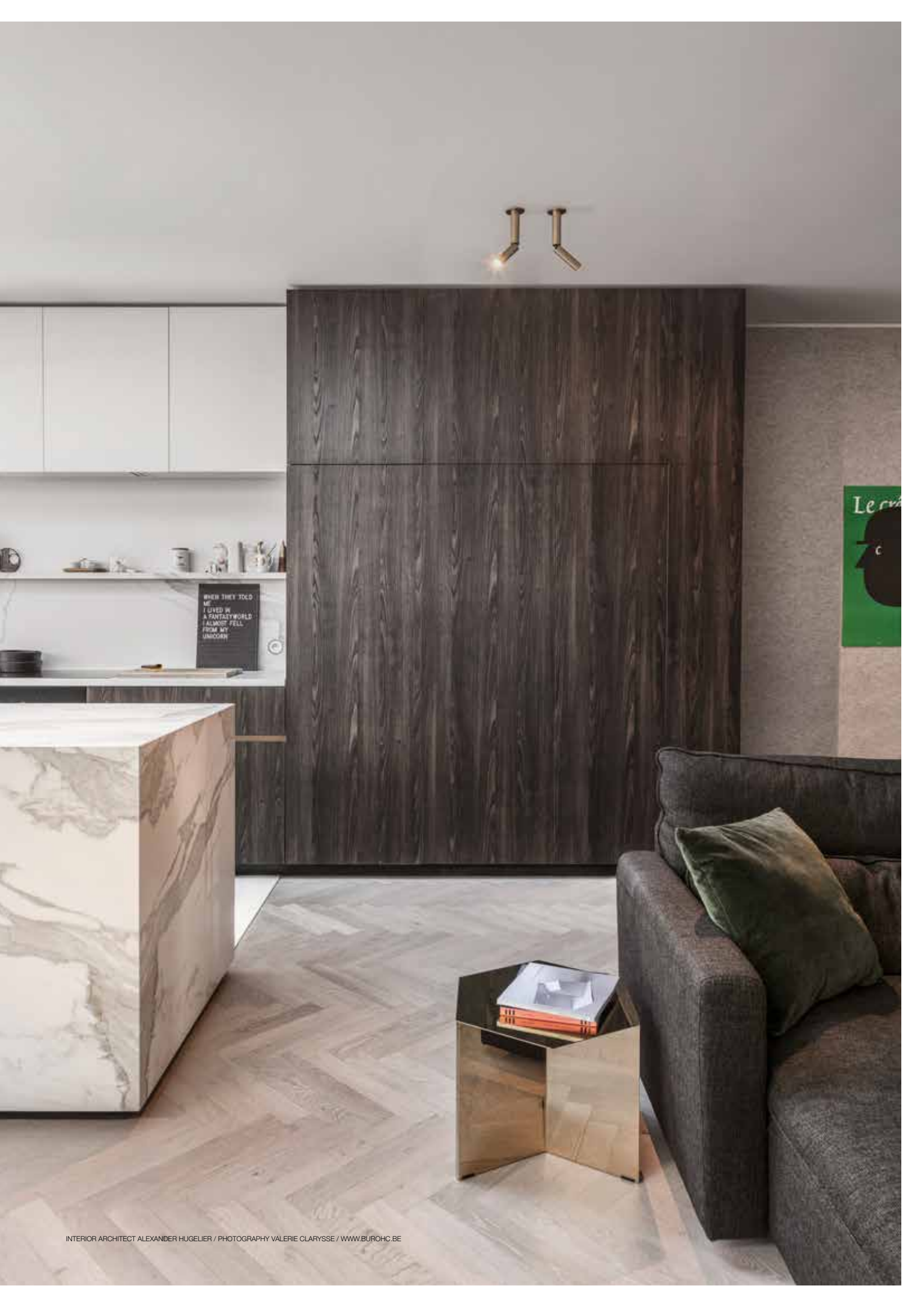



# BOXY FAMILY

What once began as a cubic luminaire is now an elaborate family of surface mounted luminaires, both cubic and cylindrical shaped.

Though different in shape they are still uniform in look, as both shapes have a deeper recessed LED module with a conical, colored insert in front. While the deeper recessed LED module reduces the glare, the choice in color creates possibilities for playful and attractive lighting solutions.

Alongside the different shapes, this family offers indoor and outdoor luminaires, a perfect solution when recessing is not an option.

[www.deltalight.us/boxy](http://www.deltalight.us/boxy)  
[www.deltalight.ca/boxy](http://www.deltalight.ca/boxy)



**FAMILY OVERVIEW**

**CHOOSE YOUR FINISH**



Black / White  
 Black-Flemish Bronze / Black-Flemish Gold /  
 Black-Gold Matt / White-Black

**CHOOSE YOUR SHAPE & SIZE**



Round – Boxy & Boxy XL  
 Square – Boxy & Boxy XL

**CHOOSE YOUR INSTALLATION**

Surface Mounted / Suspended

**CHOOSE YOUR LIGHT SOURCE & POWER**

Boxy  
 10,4W - 1130lm

Boxy XL  
 23,2W - 3170lm

**CHOOSE YOUR COLOR TEMPERATURE**

2700K / 3000K / 3500K

**CHOOSE YOUR OPTICS**

Boxy 33°  
 Boxy XL 20° / 37°

**CHOOSE YOUR CONTROL**

0-10V Dim / Phase Dimming

**CHOOSE YOUR ACCESSORY**

Honeycomb / Softening Lens / Glass SBL

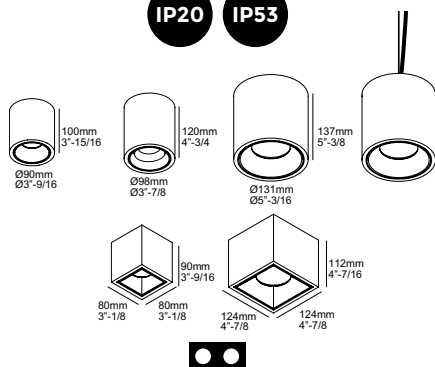



ARCHITECTS O'DONNELL + TUOMEY

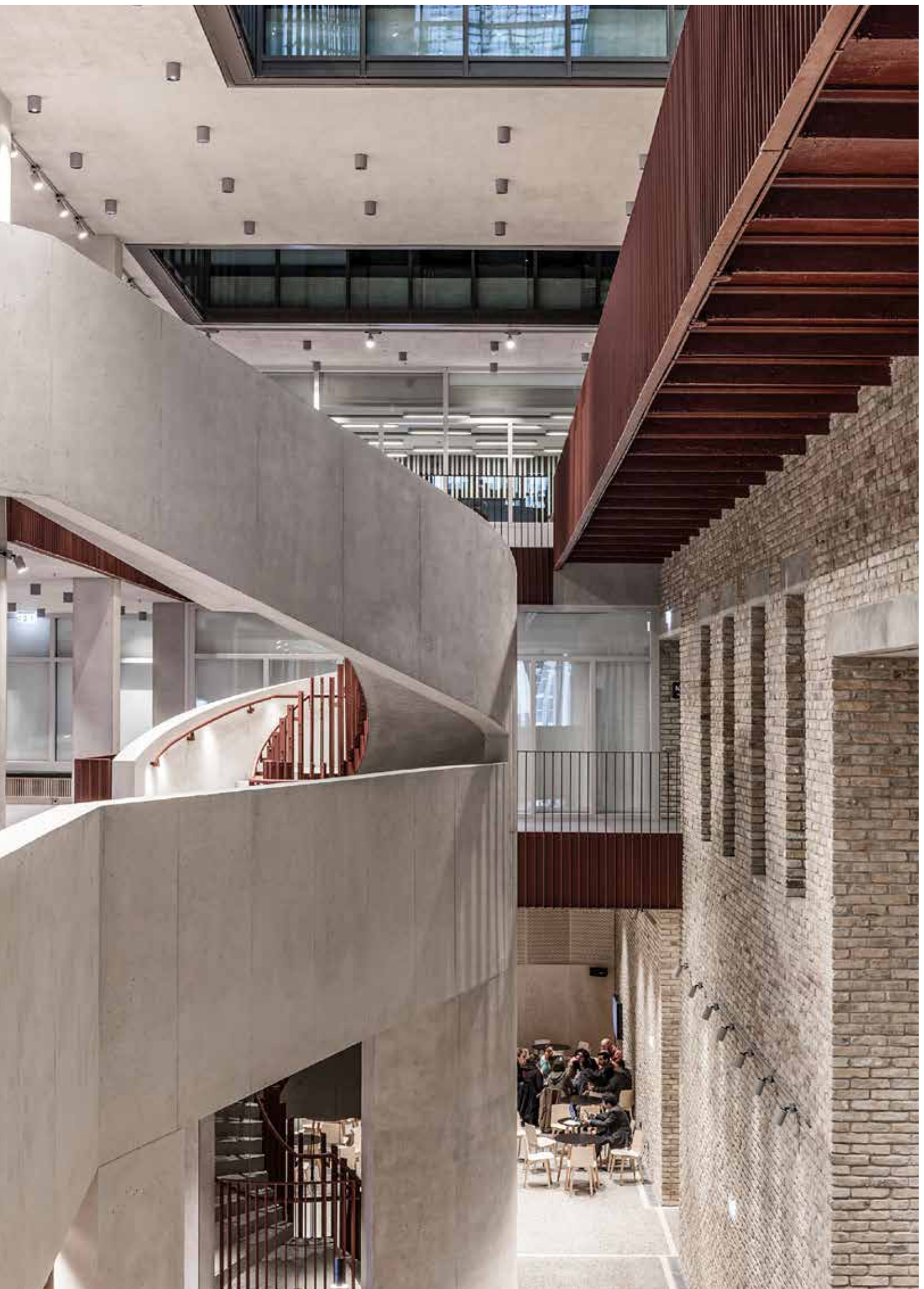

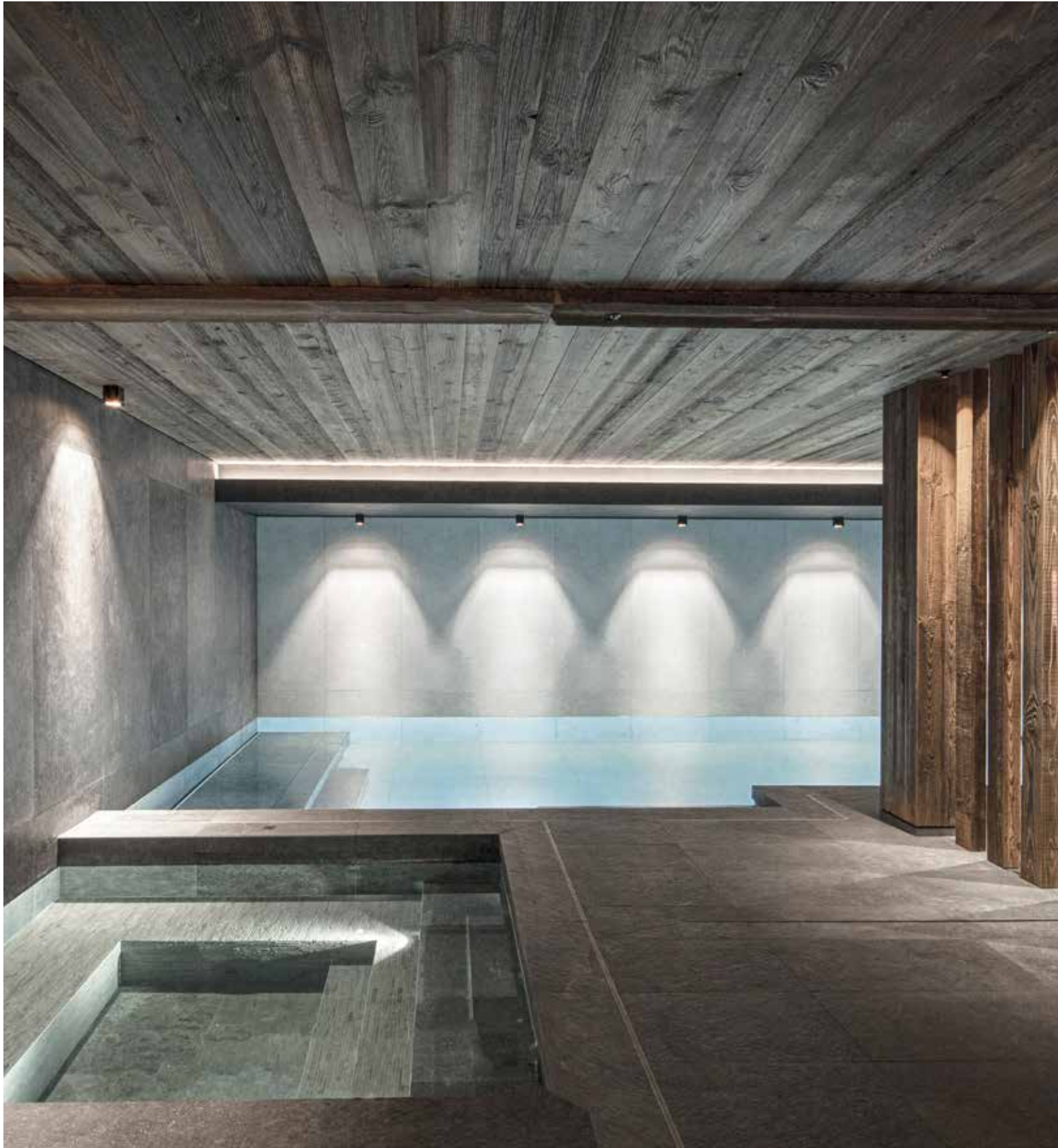

ARCHITECT MEGÈVE DESIGN & AGENCE DAMIEN CARRERES





ARCHITECT MSM MEYERSCHMITZMORKRAMER, KÖLN / INTERIOR ARCHITECT LEPEL & LEPEL, KÖLN / PHOTOGRAPHER: HG ESCH / LIGHTING DESIGN AG LICHT, BONN





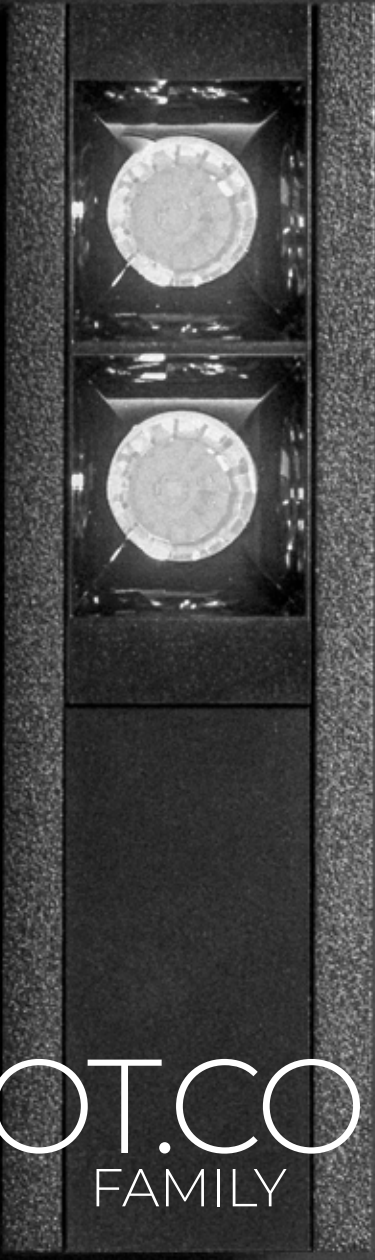

# DOT.COM FAMILY

First introduced in 2004 as a single LED luminaire, upscaled in 2008 as a multiple LED luminaire with 4 or 6 LED dots, implemented in the profile section in 2010 as a module with 4 or 6 LEDs, the history of Dot.Com within the Delta Light range goes way back. With LEDs being utterly functional and performant nowadays, Dot.Com is up to its second revival, coming as a complete family of luminaires with multiple LED dots to create the most discreet, yet highly functional light settings.

[www.deltalight.us/dot-com](http://www.deltalight.us/dot-com)  
[www.deltalight.ca/dot-com](http://www.deltalight.ca/dot-com)

**DOT.COM S**

The Small version only needs 1" - 25mm of width, a nearly invisible appearance yet with visible impact.

**DOT.COM M**

The Medium range includes an adjustable version with trim and a trimless solution. The adjustable Dot.Com M – with tilting possibility up to 30° - is ideal for instance to emphasize an artwork on the wall. The specific design of the trimless luminaire grants the opportunity to install it either completely into the ceiling or semi-recessed, to evoke more expression into the room.

**DOT.COM L**

With an output up to 12W per luminaire, the Large range is the most powerful within the Dot.Com series. The Large version is the only version within the Dot.Com range that also offers surface mounted alternatives. Similar as for recessed installation, Dot.Com L brings a 2 LED and a 4 LED version within a compact design. With its low glare - thanks to the combination of individual reflectors per LED - Dot.Com L is perfectly applicable for office use.



**FAMILY OVERVIEW**

**CHOOSE YOUR FINISH**

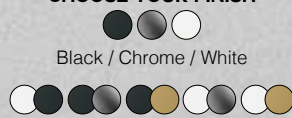

Black / Chrome / White  
White-Black / Black-Chrome / Black-Gold Matt / White-Chrome / White-Gold Matt

**CHOOSE YOUR INSTALLATION**

Small  
Recessed / Trim  
Medium  
Recessed / Trim or trimless  
Large: Recessed  
Trim / Surface mounted

**CHOOSE YOUR SIZE & POWER**

Small  
3W up to 6W - 300 up to 610lm (UGR<16)  
Medium  
5,6W - 630lm (UGR<16)  
Large  
4W up to 12,4W - 420 up to 1180lm (UGR<16)

**CHOOSE YOUR COLOR TEMPERATURE**

2700K / 3000K / 3500K

**CHOOSE YOUR OPTICS**

Small  
34° / 59°  
Medium  
14° / 33° / 49°  
Large  
16° / 32° / 46°

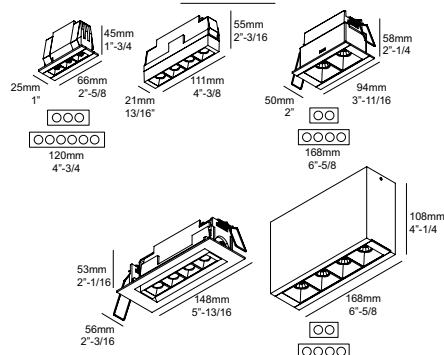

A large, circular, textured wall-mounted object, possibly a piece of art or a decorative element, is centered on a white wall. The object has a mottled, earthy brown and tan color with a slightly irregular, organic shape. The room is minimalist, with white walls and a dark grey floor. Two recessed ceiling lights are visible at the top of the frame.

DOT.COM  
WALLWASH  
FAMILY

**DOT.COM WALLWASH**

Dot.Com is not only limited to spotlight beam angles, it also has linear wallwashers in its range for a soft, even light effect on vertical surfaces. These come as single luminaires both recessed as surface mounted, as modules to fit in the magnetic profiles and as a bespoke trimless profile solution, perfect to adapt the light to your specific desires.

[www.deltalight.us/dot-com](http://www.deltalight.us/dot-com)  
[www.deltalight.ca/dot-com](http://www.deltalight.ca/dot-com)



**FAMILY OVERVIEW**

**CHOOSE YOUR FINISH**



Black / White

**CHOOSE YOUR INSTALLATION**

Recessed / Surface mounted / Suspended

**CHOOSE YOUR POWER**

10W up to 25,2W - 1000 up to 3000lm

**CHOOSE YOUR COLOR TEMPERATURE**

2700K / 3000K / 3500K

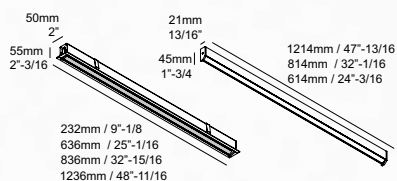



INTERIOR DESIGN OMAR ABDELGHAFOUR - LIGHT SPACE DESIGN / CONCEPT BLACK FOR GREEN SCAPE





INTERIOR CEILING









# HALOSCAN

PATENTED EX-CENTRIC ROTATION SYSTEM

## FAMILY

Haloscan is a family of accent lights that come semi-recessed or as modules on the magnetic profiles. Designed around its flat optics, Haloscan combines ultra-minimalistic looks with a pleasurable light effect. The light is softly spread by the plane lens, creating up to 4 different beam angles, from spot to floodlight and even linear light.

To smoothly turn and tilt, Haloscan uses the Ex-Centric Rotation System, an asymmetrical hinge that combines rotating and tilting abilities in one swift move.

[www.deltalight.us/haloscan](http://www.deltalight.us/haloscan)  
[www.deltalight.ca/haloscan](http://www.deltalight.ca/haloscan)



**FAMILY OVERVIEW**

**CHOOSE YOUR FINISH**



Black / Gold Colored / White

**CHOOSE YOUR INSTALLATION**

Semi recessed – With trim or as Clip version

**CHOOSE YOUR POWER**

8,6W up to 11,7W – 1090 up to 1520lm

**CHOOSE YOUR COLOR TEMPERATURE**

2700K / 3000K / 3500K / Soft Dim

**CHOOSE YOUR OPTICS**

14° / 21° / 35°

**CHOOSE YOUR APPLICATION**

Trim

New Construction

Remodel

–

Clip

New Construction

Remote Power supply

**CHOOSE YOUR CONTROL**

0-10V / Phase Dimming /

Lutron Eco

**CHOOSE YOUR ACCESSORY**

Honeycomb / Linear Spread Lens

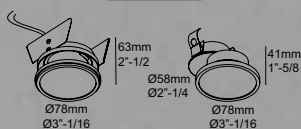













reddot design award  
winner



AWARD  
DESIGN PLUS  
light+building



# TWEETER

PATENTED EX-CENTRIC ROTATION SYSTEM

## FAMILY

Tweeter has been one of the most remarkable families in the Delta Light collection for many years. Available as ceiling recessed and ceiling surface mounted, Tweeter introduces new levels in flexibility, both in movement as in lighting application. Tweeter is based on Delta Light's Ex-centric Rotation System, characterized by an asymmetrical hinge joint, combining extreme rotation and tilting abilities, all in one swift whirling motion.

The recessed Tweeter versions enable a maximum fuse of light and architecture. The spotlight heads are identical to the surface mounted installation and handling is simple and convenient. The double shell design prevents ceiling exposure, while the flexible inner shell tailors for any lighting need. Ultimate refinement is reached with a subtle aureole of light circling around the central led, offering improved lighting aesthetics. The application of the Ex-centric Rotation System not only upgrades movement of the fixture, but more importantly also provides advanced lighting abilities. The rotation mechanism was designed so that the light beam is not cut off, resulting in maximum efficiency.

[www.deltalight.us/tweeter](http://www.deltalight.us/tweeter)  
[www.deltalight.ca/tweeter](http://www.deltalight.ca/tweeter)





The Tweeter On strikes a perfect balance between lighting quality and energy efficiency, adding value to the design statement of its environment. This striking yet elegant fitting suits every interior environment, pleasing the user with its supreme suppleness and intriguing appearance. Tweeter excels thanks to its ingenious design, refined to the last detail.

**FAMILY OVERVIEW**

**CHOOSE YOUR FINISH**



Black-White / White

**CHOOSE YOUR INSTALLATION**

Recessed – Trim / Trimless  
Surface mounted

**CHOOSE YOUR POWER**

10.4W up to 15W - 1075 up to 1446lm

**CHOOSE YOUR COLOR TEMPERATURE**

2700K / 3000K / 3500K / Soft Dim

**CHOOSE YOUR OPTICS**

33° / 50°

**CHOOSE YOUR APPLICATION**

Recessed - Trim / Trimless  
-  
New Construction  
Remodel

**CHOOSE YOUR CONTROL**

Recessed - Trim / Trimless  
-  
0-10V / Phase Dimming /  
Lutron Eco / Lutron 2-Wire

**CHOOSE YOUR ACCESSORY**

Honeycomb / Glass SBL / Linear Spread Lens /  
Softening Lens / Spread Lens

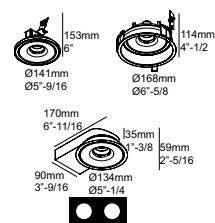



NINA MAYA INTERIORS / PHOTO: NICOLE ENGLAND





REID-SENEPART ARCHITECTEN





INTERIEURBURO PEDRO VERHUE

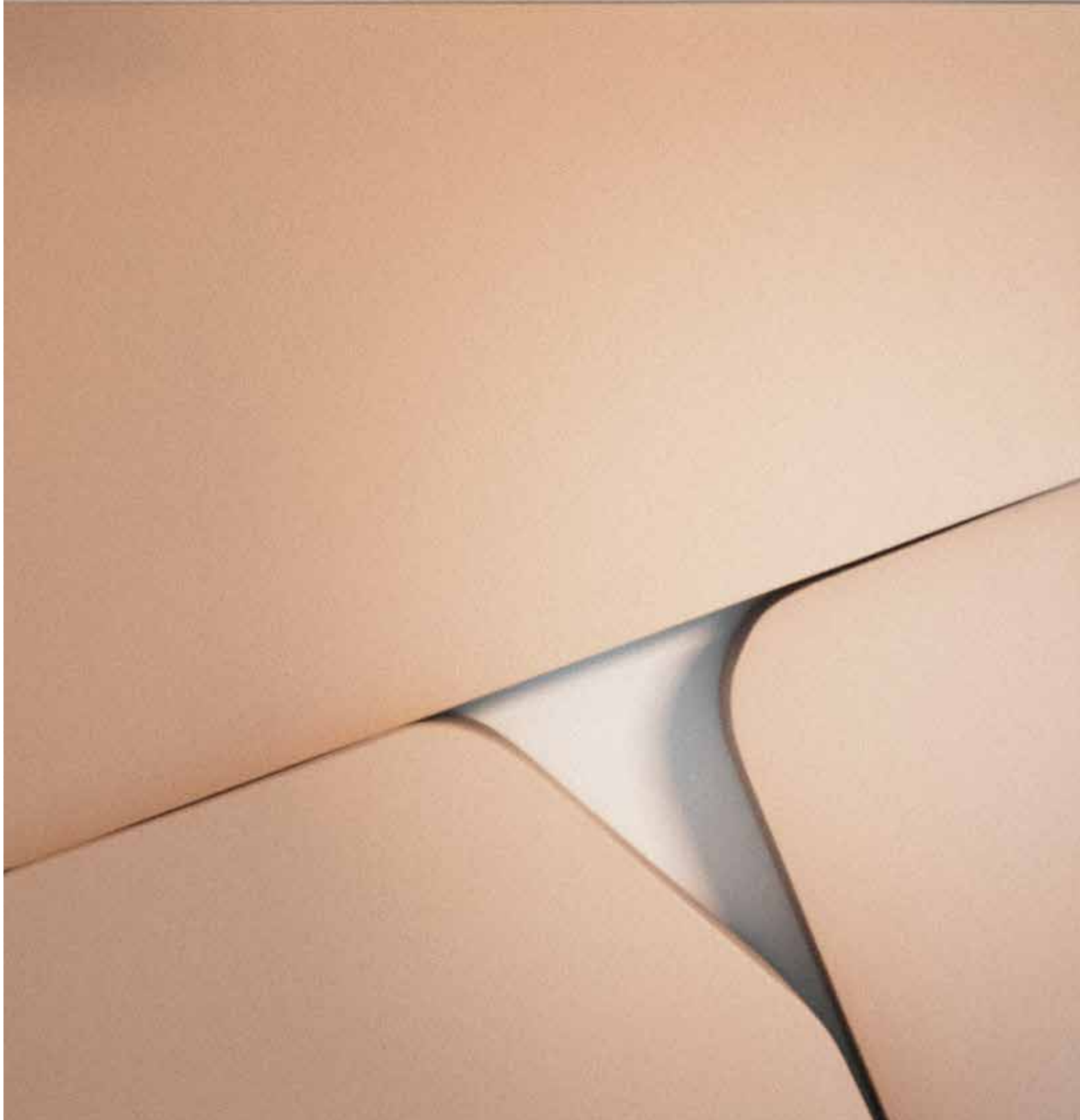

# ODRON

## FAMILY

### HAVE ANOTHER LOOK

Don't be fooled: Odron may look peculiar at first sight, nevertheless its specific design is intended to create a compact yet powerful lighting solution.

As from now, any additional look on it makes you appreciate Odron more and more: its possibility to serve both as a straightforward downlight or as an omnidirectional spotlight, the shiny details of the cover in contrast with the structured lacquer of the body or the touch of color it adds thanks to the additional golden cover, it is clear that Odron enriches the space in more than one way.

The elegant Odron is available as a clip version or as module for our Magnetic profile range.

[www.deltalight.us/odron](http://www.deltalight.us/odron)  
[www.deltalight.ca/odron](http://www.deltalight.ca/odron)

### FAMILY OVERVIEW

#### CHOOSE YOUR FINISH



Black / White

Finish off with a golden cover

#### INSTALLATION

Semi-recessed

#### CHOOSE YOUR POWER

6,1W up to 9W - 780 up to 1080lm

#### CHOOSE YOUR COLOR TEMPERATURE

2700K / 3000K / 3500K

#### CHOOSE YOUR OPTICS

28° / 41°

#### CHOOSE YOUR APPLICATION

New Construction

Remote

#### CHOOSE YOUR CONTROL

0-10V / Phase Dimming /

Lutron Eco



# BOWIE

## FAMILY

### **KEEP YOUR EYE ON THE BALL**

Add some body to the room with Bowie, it impresses through its spherical shape. Twist and turn, tilt and aim, Bowie will always look the same, whatever its direction and no matter the angle you look at it. Bowie in pure white or black easily fits in any interior and adds a touch of richness to the room.

Within its range, Bowie comes as a semi-recessed Clip version or as module to fit into our Magnetic profile offer.

[www.deltalight.us/bowie](http://www.deltalight.us/bowie)  
[www.deltalight.ca/bowie](http://www.deltalight.ca/bowie)





**FAMILY OVERVIEW**

**CHOOSE YOUR FINISH**



White or Black

**INSTALLATION**

Semi-recessed

**CHOOSE YOUR POWER**

6,1W up to 9W - 780 up to 1080lm

**CHOOSE YOUR COLOR TEMPERATURE**

2700K / 3000K / 3500K

**CHOOSE YOUR OPTICS**

25° / 37°

**CHOOSE YOUR APPLICATION**

New Construction  
Remote Power Supply

**CHOOSE YOUR CONTROL**

0-10V / Phase Dimming /  
Lutron Eco

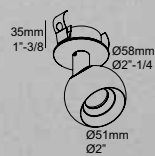



reddot design award  
winner

Don't be a pawn in someone else's game

# PION

PATENTED EX-CENTRIC ROTATION SYSTEM

## FAMILY

### THE QUEEN, NOT THE PAWN

The shape of Pion resembles a lot the one of a pawn in a game of chess, but that is also the only resemblance. Opposite to a pawn, Pion is able to move around freely thanks to its unique Ex-centric Rotation System (ERS). Starting as a fix downlight, Pion can easily be turned into a periscope overlooking the room, simply by rotating its head.

The Ex-centric Rotation System then enables Pion to tilt its head, allowing it to spy around over 355° and tilt up to 90°, so aiming possibilities are unlimited.

Its elegant design in combination with the frisky color combinations transform Pion immediately into the queen of the room, overlooking the scenery. Like any jewel, the colorful tubes serve as an accessory to top off its feminine shape in style.

[www.deltalight.us/pion](http://www.deltalight.us/pion)  
[www.deltalight.ca/pion](http://www.deltalight.ca/pion)



**BALANCED IN FORM AND FUNCTION**

Pion is available as semi-recessed version or as a plug-in module for our Magnetic profile range. As a recessed variant, the Ex-centric Rotation System is semi-recessed into the ceiling, hiding away the more technical part of the luminaire.

INTERIOR CEILING



Find the other members of this family **PROFILES**

**FAMILY OVERVIEW**

**CHOOSE YOUR FINISH**



Black / Gold Colored / White  
Finish off with a Golden or Black inner tube

**CHOOSE YOUR INSTALLATION**

Semi-recessed

**CHOOSE YOUR POWER**

6,1W up to 9W - 780 up to 1080lm

**CHOOSE YOUR COLOR TEMPERATURE**

2700K / 3000K / 3500K

**CHOOSE YOUR OPTICS**

25° / 37°

**CHOOSE YOUR APPLICATION**

New Construction  
Remote Power Supply

**CHOOSE YOUR CONTROL**

0-10V / Phase Dimming /  
Lutron Eco

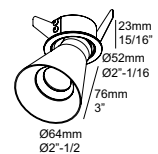











# SPY FAMILY

Minimalism, functionality and versatility are the key terms to describe this extensive collection. The Spy was designed to meet multiple lighting requirements, an ideal solution for accent lighting in residential, hospitality or commercial spaces. The range features low to high lumen packages, narrow to wide beam options, standard or specific LED colors, recessed to surface mounted applications, different color finishes and combinations, and can be equipped with multiple light refining accessories.

Following the constant changes in the world of LEDs and optics and the evolution to better user comfort with more precise optics and better light control, the complete Spy range has been upgraded. The result? Fresh shapes and additional finishing colors, better light comfort through hybrid optics, improved LED color consistency and new perspectives with Tunable White and Soft Dim.

The renewed Spy family comes in diameters of 1"-1/16" - 27mm, 1"-9/16 - 39mm, 2"-1/16 - 52mm, 2"-5/8 - 66mm, 3"-9/16 - 90mm, a range of spotlights to fit any purpose. While the smaller versions come in the lively colors Flemish Bronze, Flemish Gold and Gold Colored, the bigger Spy's offer Tunable White and Soft Dim solutions in multiple beam angles.

PATENTED EX-CENTRIC ROTATION SYSTEM



**SPY 52**

The most extensive member within the Spy family: different installation methods, multiple light refining accessories to be added, mid- and high-power LEDs and even the possibility to opt for Soft Dim or Tunable White.

Containing a more powerful LED engine than Spy 39, Spy 52 has the same elegant ratio of diameter versus length. Combined with the Ex-centric Rotation System to swivel around, Spy presents itself like a curious object peeking from the ceiling, able to spy up to 350° around the room.

Requiring only 1"-3/8" - 35mm of recessed depth, the Clip version of the Spy 52 combines easy installation together with a clean ceiling appearance and lots of functionality.

To complete the family Spy 52 is available with a Soft Dim or Tunable White LED inside. A Soft Dim version offers the cosy feeling of halogen when dimming down, changing the color temperature into a warm glow of light. Tunable White allows you to change the type of white to your preference, from warm up to very cold white.

[www.deltalight.us/spy-52](http://www.deltalight.us/spy-52)  
[www.deltalight.ca/spy-52](http://www.deltalight.ca/spy-52)



#### **SPY 66 / 90**

Spy 66 offers a range of optics to create multiple beam angles within different output levels. Ranging up to 24,6W, Spy 66 is available as Clip and On version, allowing an easy installation. With 3 beam angles in standard white LED colors and Tunable White, Spy 66 is perfect to apply in retail and public environments.

Spy 90 On is the surface mounted Spy solution for high output and ultimate performance, as it has an integrated dimmable driver inside. In line with the complete Spy range, the tubular design can be finished with the colored insert of your choice, but Maxispy On especially wows you with its output up to 3200lm and its choice of 3 different beam angles.

[www.deltalight.us/spy-66](http://www.deltalight.us/spy-66)  
[www.deltalight.ca/spy-66](http://www.deltalight.ca/spy-66)

[www.deltalight.us/spy-90](http://www.deltalight.us/spy-90)  
[www.deltalight.ca/spy-90](http://www.deltalight.ca/spy-90)

#### **SPY 39**

Compact in design, complete in functionality. Spy 39 is one of the most elaborate members of the family thanks to its multiple lumen packages, beam angles and ways of installation.

As a recessed solution, Spy 39 comes in many appearances. The Trimless version can serve both as a downlight or as an adjustable spotlight, as the body can either be completely hidden into the ceiling or fully visible to aim it wherever you want.

As surface mounted version, Spy 39 On comes with a short or longer cylinder on top. Spy 39 Clip hides away the installation part into the ceiling. The result is a single spotlight with a minimalistic yet sophisticated look.

Powering up to 8,6W and available in multiple finishing colors, Spy 39 is suitable for a range of applications.

[www.deltalight.us/spy-39](http://www.deltalight.us/spy-39)  
[www.deltalight.ca/spy-39](http://www.deltalight.ca/spy-39)

**MICROSPY**

This miniature range offers fix and adjustable recessed luminaires, with and without trim, in a spot or flood beam angle. The trimless versions of Microspy make use of the Snap-In principle, facilitating installation as the frame can be placed in advance and light modules can be added in a finishing stage. As a pendant module its slenderness allows you to create playful or humble set-ups by grouping multiple luminaires or choosing just one single pendant.

**SPY – SPY FOCUS**

As a straightforward downlight, Spy is available for direct ceiling fixation or as a pendant, ideal to create a powerful and striking light effect. With Spy Focus one can opt for different beam angles out of only 1 luminaire, as the circle of light can be widened or narrowed by rotating the front of the fittings' body. As such, every beam angle between 8° and 43° is possible.

[www.deltalight.us/spy](http://www.deltalight.us/spy)  
[www.deltalight.ca/spy](http://www.deltalight.ca/spy)

**SPY 27**

Spy 27 is the smallest of the range and comes as a Clip version. Don't be fooled by its size, with a power of 5,8W it perfectly serves for general lighting in residential environments. For optimized visual comfort, a visor is available to reduce the glare when looking into the luminaire.

[www.deltalight.us/spy-27](http://www.deltalight.us/spy-27)  
[www.deltalight.ca/spy-27](http://www.deltalight.ca/spy-27)



## FAMILY OVERVIEW

### MICROSPY

#### CHOOSE YOUR FINISH



Black / White

#### CHOOSE YOUR INSTALLATION

Recessed  
With trim / Trimless  
Suspended

#### CHOOSE YOUR POWER

3,9W up to 7,1W – 390 up to 810lm

#### CHOOSE YOUR COLOR TEMPERATURE

2700K / 3000K / 3500K

#### CHOOSE YOUR OPTICS

15° / 24° / 30°

#### CHOOSE YOUR APPLICATION

New Construction  
Remote Power Supply

#### CHOOSE YOUR CONTROL

0-10V / Phase Dimming /  
Lutron Eco / Lutron 2-Wire

### SPY / SPY FOCUS

#### CHOOSE YOUR FINISH



Black / Flemish Bronze /  
Flemish Gold / White



Front tube in  
Black / Flemish Bronze / Flemish Gold /  
Gold Matt / Silver Grey / White

#### CHOOSE YOUR INSTALLATION

Semi-recessed  
Surface mounted  
Suspended

#### CHOOSE YOUR LIGHT SOURCE & POWER

LED  
6,1W up to 17,2W - 780 up to 2100

#### CHOOSE YOUR COLOR TEMPERATURE

2700K / 3000 / 3500K

#### CHOOSE YOUR OPTICS

33° / Focus 8° to 43°

#### CHOOSE YOUR APPLICATION

Remodel  
New Construction  
Remote Power Supply

#### CHOOSE YOUR CONTROL

0-10V / Phase Dimming /  
Lutron Eco / Lutron 2-Wire

### SPY 27

#### CHOOSE YOUR FINISH



Black / Flemish Bronze / Flemish Gold /  
Gold Colored / White

#### CHOOSE YOUR INSTALLATION

Semi-Recessed  
Short / Long

#### POWER

5,8W – 790lm

#### CHOOSE YOUR COLOR TEMPERATURE

2700K / 3000K / 3500K

#### OPTICS

30°

#### CHOOSE YOUR APPLICATION

New Construction  
Remote Power Supply

#### CHOOSE YOUR CONTROL

0-10V / Phase Dimming /  
Lutron Eco / Lutron 2-Wire

#### ACCESSORY

Visor



**SPY 39**

**CHOOSE YOUR FINISH**



Black / Flemish Bronze / Flemish Gold / Gold Colored / White



Front tube in  
Black / Flemish Bronze / Flemish Gold / Gold Colored / White

**CHOOSE YOUR INSTALLATION**

Recessed  
With trim / Trimless

Semi-recessed  
Short / Long

Surface mounted  
Short / Long

**CHOOSE YOUR POWER**

5,8W up to 8,6W – 790 up to 1090lm

**CHOOSE YOUR COLOR TEMPERATURE**

2700K / 3000K / 3500K

**CHOOSE YOUR OPTICS**

20° / 40°

**CHOOSE YOUR APPLICATION**

New Construction  
Remote Power Supply

**CHOOSE YOUR CONTROL**

0-10V / Phase Dimming /  
Lutron Eco / Lutron 2-Wire

**ACCESSORY**

Visor

**SPY 52**

**CHOOSE YOUR FINISH**



Black / Flemish Bronze / Flemish Gold / Gold Colored / White



Front tube in  
Black / Flemish Bronze / Flemish Gold / Gold Colored / White

**CHOOSE YOUR INSTALLATION**

Recessed  
With trim / Trimless

Semi-recessed

Surface mounted

**CHOOSE YOUR POWER**

5,8W up to 12,4W - 790 up to 1470lm

**CHOOSE YOUR COLOR TEMPERATURE**

2700K / 3000K / 3500K / Soft Dim /  
Tunable White

**CHOOSE YOUR OPTICS**

20° / 45°

**CHOOSE YOUR APPLICATION**

New Construction  
Remodel  
Remote Power Supply

**CHOOSE YOUR CONTROL**

0-10V / Phase Dimming /  
Lutron Eco / Lutron 2-Wire

**CHOOSE YOUR ACCESSORY**

Honeycomb / Glass SBL / Linear Spread  
Lens / Softening Lens / Spread Lens

**SPY 66**

**CHOOSE YOUR FINISH**



Black / White



Front tube in  
Black / Flemish Bronze / Flemish Gold / Gold Colored / White

**CHOOSE YOUR INSTALLATION**

Semi-recessed

Surface mounted

**CHOOSE YOUR POWER**

11,6W up to 25W - 1520 up to 2810lm

**CHOOSE YOUR COLOR TEMPERATURE**

2700K / 3000K / 3500K / Tunable White

**CHOOSE YOUR OPTICS**

18° / 30° / 45°

**CHOOSE YOUR APPLICATION**

New Construction  
Remote Power Supply

**CHOOSE YOUR CONTROL**

0-10V / Phase Dimming /  
Lutron Eco / Lutron 2-Wire

**CHOOSE YOUR ACCESSORY**

Honeycomb / Glass SBL / Linear Spread  
Lens / Softening Lens / Spread Lens

**SPY 90**

**CHOOSE YOUR FINISH**



Black / White



Front tube in  
Black / Flemish Bronze / Flemish Gold / Gold Colored / White

**INSTALLATION**

Surface mounted

**POWER**

23,2W – 3170lm

**CHOOSE YOUR COLOR TEMPERATURE**

2700K / 3000K / 3500K

**CHOOSE YOUR OPTICS**

18° / 30° / 45°

**CONTROL**

0-10V Dim

**CHOOSE YOUR ACCESSORY**

Honeycomb / Glass SBL / Linear Spread  
Lens / Softening Lens / Spread Lens

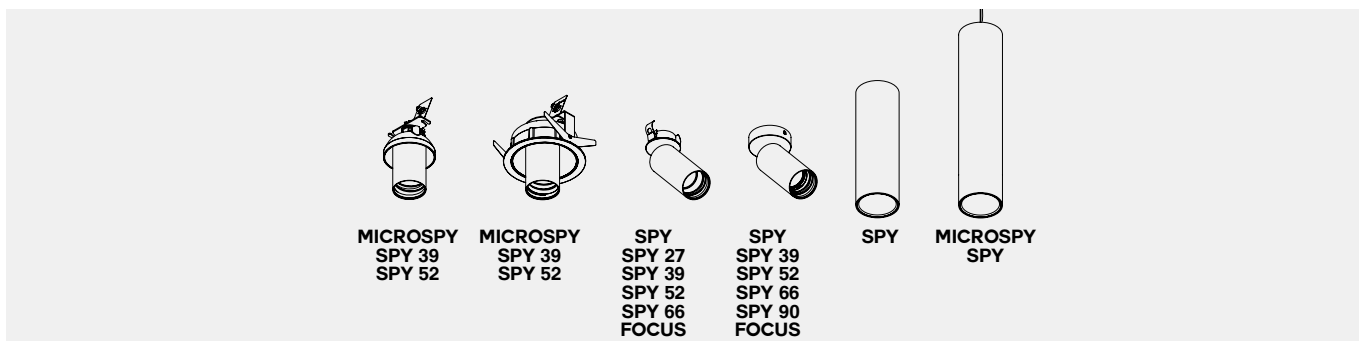

**MICROSPY**  
SPY 39  
SPY 52

**MICROSPY**  
SPY 39  
SPY 52

**SPY**  
SPY 27  
SPY 39  
SPY 52  
SPY 66  
FOCUS

**SPY**  
SPY 39  
SPY 52  
SPY 66  
FOCUS

**SPY**

**MICROSPY**  
SPY









MANIA-K



# SUPER-OH!

FAMILY





**SUPER-OH! SLIM**

Evolving from our existing Super-Oh! family, Super-Oh! Slim stands out in design and efficiency. With a width of only 1"-3/4 - 44mm and a luminous efficacy up to 119lm/W, this family of halo's combines slender elegance with big performance. Super-Oh!

Slim comes in 2 diameters - 31"-1/2 - 800mm and 47"-1/4 - 1200mm - and is available with only direct light or a combination of direct and indirect light.

[www.deltalight.us/super-oh-slim](http://www.deltalight.us/super-oh-slim)  
[www.deltalight.ca/super-oh-slim](http://www.deltalight.ca/super-oh-slim)

**SUPER-OH! SLIM**

**CHOOSE YOUR FINISH**



Black / White

**CHOOSE YOUR DESIGN**

With ceiling base

**CHOOSE YOUR SIZE & POWER**

Ø 31"-1/2 - 800mm  
 Down / 48W - 7200lm  
 Down-Up / 71W - 11000lm

Ø 47"-1/4 - 1200mm  
 Down / 71W - 10800lm  
 Down-Up / 107W - 16500lm

**CHOOSE YOUR COLOR TEMPERATURE**

3000K / 3500K

**INSTALLATION**

Suspended (Down or Down-Up)

**CONTROL**

0-10V Dim

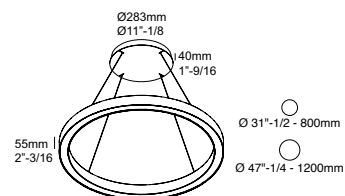





**SUPER-OH!**

A series of slim black rings floating through space, finished either with integrated powerleds or the more retro-look version with classic light bulbs.

[www.deltalight.us/super-oh](http://www.deltalight.us/super-oh)

[www.deltalight.ca/super-oh](http://www.deltalight.ca/super-oh)

**SUPER-OH!**

**CHOOSE YOUR FINISH**



Black

**CHOOSE YOUR LIGHT**

LED

E26

**CHOOSE YOUR COLOR TEMPERATURE**

2700K / 3000K

**CHOOSE YOUR SIZE & POWER**

Ø27"-9/16 - 700mm

3 x 6W – 560lm

Ø47"-1/4 - 1200mm

6 x 6W – 560lm

Ø66"-15/16 - 1700mm

8 x 6W – 560lm

**CONTROL**

Remote

0-10V / Phase Dimming /  
Lutron Eco / Lutron 2-Wire

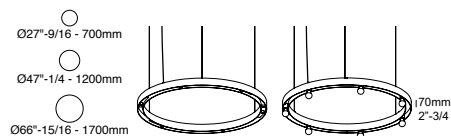



ARCHITECT W: ARCHITEKTEN / PHOTOGRAPHY FOTOGRAFIE FREI





INTERIOR ARCHITECTURE BY @AFC-COLLECTION





reddot design award  
winner



GOOD  
DESIGN  
award

# SUPERLOOP

A luminaire can be more than light alone. It can be functional, it can be decorative, it can be an eye catcher. This family not only exists out of circles of light, it also brings circular and squared low voltage solutions for track lighting, so general and accent lighting can be combined within one family. In this way, Superloop allows you to choose 'functional', by mounting adjustable Spy modules on the round or square shaped base. It allows you to choose 'decorative', by mounting the light emitting circle in a horizontal way, or it allows you to choose 'eye catcher', by carelessly hanging the circle of light vertical, as a statement.

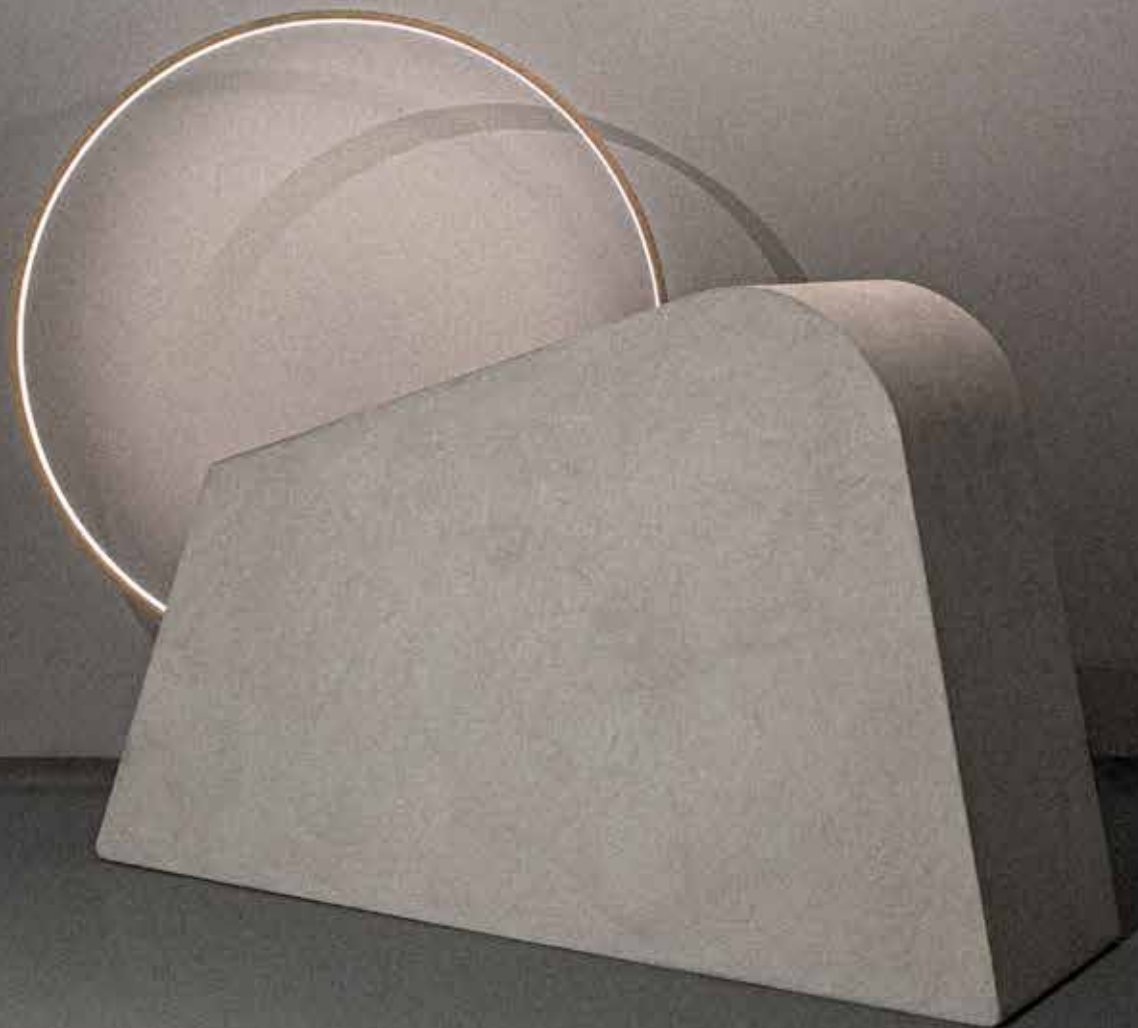

**SUPERLOOP SBL**

Superloop HC with circular light has the ability to diffuse light all around. It represents a universal symbol with extensive options, a perfect circle of light, rolled out of 1 aluminium profile and seamlessly welded together. The specially designed current controlled LEDflex inside Superloop SBL allows it to be dimmed in various ways. Diameters up to 66"-15/16 - 1700mm and finishes in different colors let you create the setting you want.

Similar to Superloop SBL HC, but more dramatic in expression, Superloop SBL VC grants the opportunity to use light in a different way. The vertical circle of light draws the attention and stimulates creativity.

For a more bold and expressive application you can opt for the Superloop VR, mounting the circle of light with a steel rod. Sculptural in presence, resonating with symbolism and respecting pure minimalism, the Superloop VR offers a very airy and remarkable element to your interior concept. Either as a single version or in a sequence to create striking vertical effects.

[www.deltalight.us/superloop-sbl](http://www.deltalight.us/superloop-sbl)  
[www.deltalight.ca/superloop-sbl](http://www.deltalight.ca/superloop-sbl)



**SUPERLOOP SBL**

**CHOOSE YOUR FINISH**



Black, Flemish Bronze, Flemish Gold, White

**CHOOSE YOUR SIZE & POWER**

- Round
- Ø27"-9/16 - 700
- Ø35"-7/16 - 900
- Ø47"-1/4 - 1200
- Ø66"-15/16 - 1700
- 2800 up to 6700lm

**COLOR TEMPERATURE**

3000K

**CHOOSE YOUR INSTALLATION**

Horizontal / vertical

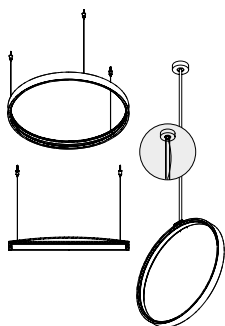

### **SUPERLOOP MDL**

Superloop is also available in a round or square shape with a Delta Light custom engineered 48V low voltage track on the inside. This allows you to position and move light modules all around, offering maximum flexibility and allowing you to meet any need of the project.

The modules enable you to move from subtle functionality to very expressive or timeless elegance. The Flemish Gold and Flemish Bronze finishes or the Spot modules Vizir and Hedra offer you a way to upgrade the minimal appearance of the loop. By adding the Fix modules with down- or down-up light, combined with a clear or frosted glass, you can transform your Superloop into a modern chandelier. Looking for a more expressive and unique statement? Just plug and play with the ledtubes of the XY180 collection.

[www.deltalight.us/superloop-mdl](http://www.deltalight.us/superloop-mdl)  
[www.deltalight.ca/superloop-mdl](http://www.deltalight.ca/superloop-mdl)



PATENTED





**SUPERLOOP MDL**

**CHOOSE YOUR FINISH**



Black, Flemish Bronze, Flemish Gold

**CHOOSE YOUR SIZE**

**ROUND**

Ø27"-9/16 -700

Ø35"-7/16 -900

Ø47"-1/4-1200

Ø66"-15/16 -1700

**SQUARE**

23"-5/8 x 23"-5/8 - 600 x 600mm

35"-7/16 x 35"-7/16 - 900 x 900mm

**RECTANGULAR**

9"-13/16 x 43"-5/16 - 250 x 100mm

9"-13/16 x 66"-15/16 - 250 x 1700mm

**CHOOSE YOUR LIGHT EFFECT**

Accent lighting: Spy / Vizir / Hedra

General light: Fix / XY180

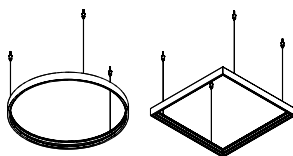



INTERIOR DESIGN WEWANTMORE



ARCHITECT WALL ARCHITECTS / PHOTOGRAPHY ILYA IVANOV



INTERIEURBURO PEDRO VERHUE





ADOMO / PHOTOGRAPHY GAVRIIL PAPADIOTIS WWW.GAVRIILUX.COM



ARCHITECT MILENA VUKMIROVIĆ DARCH







# SOLISCAPE

PATENT PENDING

---

UNStudio and Delta Light have joined forces to endeavour to improve the wellbeing of people in our rapidly changing work environments, where human health and the war on talent have become a primary focus of employers.

Together we are developing a system that facilitates, responds and contributes to solving these complex challenges.

An extremely versatile and flexible system, specifically designed to create human-centric environments.

[www.deltalight.us/soliscap](http://www.deltalight.us/soliscap)

[www.deltalight.ca/soliscap](http://www.deltalight.ca/soliscap)

Design by **UNStudio** & Delta Light

# UNStudio

FRANKFURT • SHANGHAI • HONG KONG  
AMSTERDAM

**UNStudio**, founded in 1988 by Ben van Berkel and Caroline Bos, is a Dutch architectural design studio specialising in architecture, interior architecture, product design, urban development and infrastructural projects. The name, UNStudio, stands for United Network Studio, referring to the collaborative nature of the practice.

Throughout over 30 years of international project experience, UNStudio has continually expanded its capabilities through prolonged collaboration with an extended network of international consultants, partners, and advisors across the globe. This network, combined with the centrally located offices in Amsterdam, Shanghai, Hong Kong and Frankfurt, enables UNStudio to work efficiently anywhere in the world. With already 120 built projects in Asia, Europe, and North America, the studio continues to expand its global presence with recent commissions in among others China, South-Korea, Australia, Germany and the UK.

As a network practice, a highly flexible methodological approach has been developed which incorporates parametric designing and collaborations with leading specialists in other disciplines.

The office has worked internationally since its inception and has produced a wide range of work ranging from public buildings, infrastructure, offices, residential, products, to urban masterplans.

Current projects include the mixed-use FOUR development in Frankfurt, the wasl Tower in Dubai and the Southbank by Beulah development in Melbourne. Pivotal realised projects include the Mercedes-Benz Museum in Stuttgart, Arnhem Central Station, Raffles City Hangzhou in China, the Mobius House in the Netherlands and the Erasmus Bridge in Rotterdam.



"From architecture to product design and from research to innovation; we always aim to find new ways to design for a better reality, with the user constantly at the center of everything we conceive."



#### **BEN VAN BERKEL**

Professor AA Dipl. (Hons), (F)RIBA, Hon. FAIA  
 Founder / Principal Architect UNStudio  
 Founder UNSense

Ben van Berkel studied architecture at the Rietveld Academy in Amsterdam and at the Architectural Association in London, receiving the AA Diploma with Honours in 1987.

In 2018 Ben van Berkel founded UNSense, an Arch Tech company that designs and integrates human-centric tech solutions for the built environment. Ben van Berkel has lectured and taught at many architectural schools around the world. From 2011 to 2018 he held the Kenzo Tange Visiting Professor's Chair at Harvard University Graduate School of Design, where he led a studio on health and architecture. In 2017, Ben van Berkel also gave a TEDx presentation about health and architecture. In addition, he is a member of the Taskforce Team / Advisory Board Construction Industry for the Dutch Ministry of Economic Affairs.



## TOOLBOX

The system is a toolbox of flexible components for architects and designers, that will enable them to create workable and liveable solutions for their projects;

a system that combines lighting with acoustics and IOT, into an aesthetically appealing solution that can easily connect to any building management system. The system is also flexible and future-proof, as it allows for new materials and functions to be added in the future.

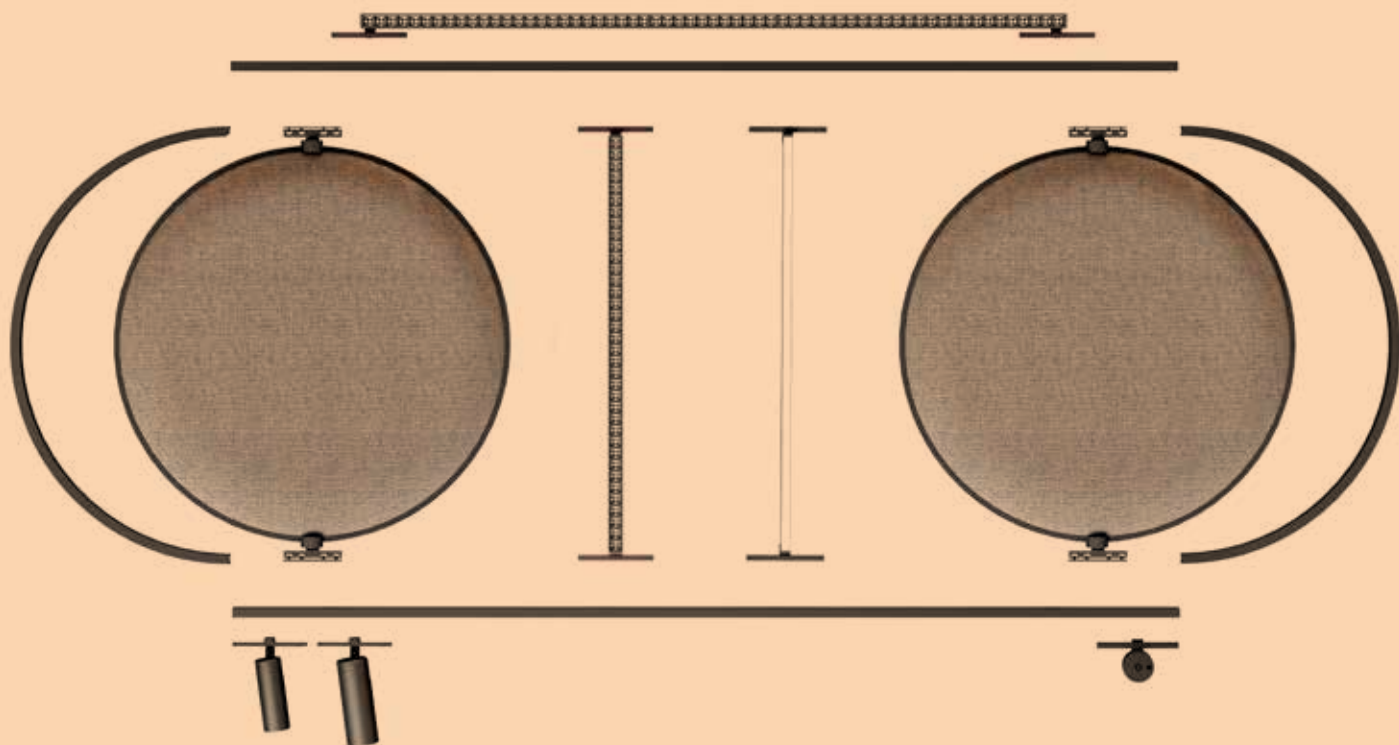



## ADAPTIVE DESIGN

The intention is to create flexible lightscapes that are responsive to the user's ever-changing needs and activities, where design is no longer imposed by the designers, but guided by the user, resulting in responsive and adaptive design. The system combines miniaturization and personalization, in a unique design language.

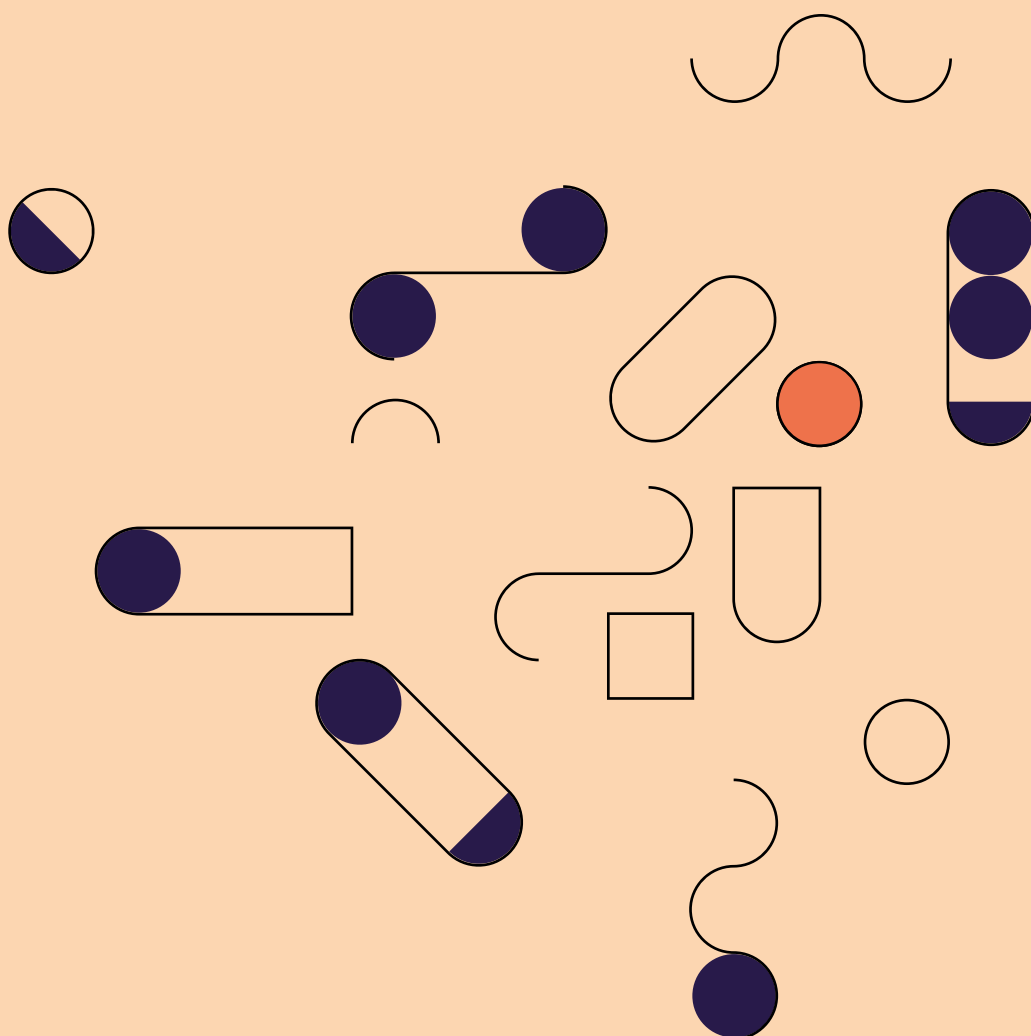



## SENSORIAL RESPONSIVE

UNStudio and Delta Light aim to create sensor-based environments that respond, learn and adjust to people's daily activities, taking smart buildings towards responsive architecture through a system that allows people intuitive control and personalisation of space. Soliscape offers different sensing options enabling you to create human-centric spaces.  
Light in function of wellbeing.



# IV

## HUMANIZING SPACES

Humanizing spaces involves investigating their behavioural science. We influence the productivity and the wellbeing of users, by allowing a more intuitive control of the space in a scenario based development. The system is about optimizing visual performance with visual comfort and the quality of the environment, responding to multiple contextual variables and activity based actions, upgrading the overall sense of space.





## COMPREHENSIVE

A combination of individual functions in one all-encompassing system, offers a more affordable and efficient tool to work with. Alongside the affordability of the single components, in the service economy, further affordability is created with the scalability of the system, where products tango with services.





**VI****SUSTAINABLE**

With its basic framing, the system allows for a variety of complementary circular materials to expand its aesthetics, and for its language to morph, whilst retaining a clear and strong aesthetic. Different materials can be used within the system to facilitate for specific functionalities, from acoustic to decorative and illuminous atmospheric scenes.







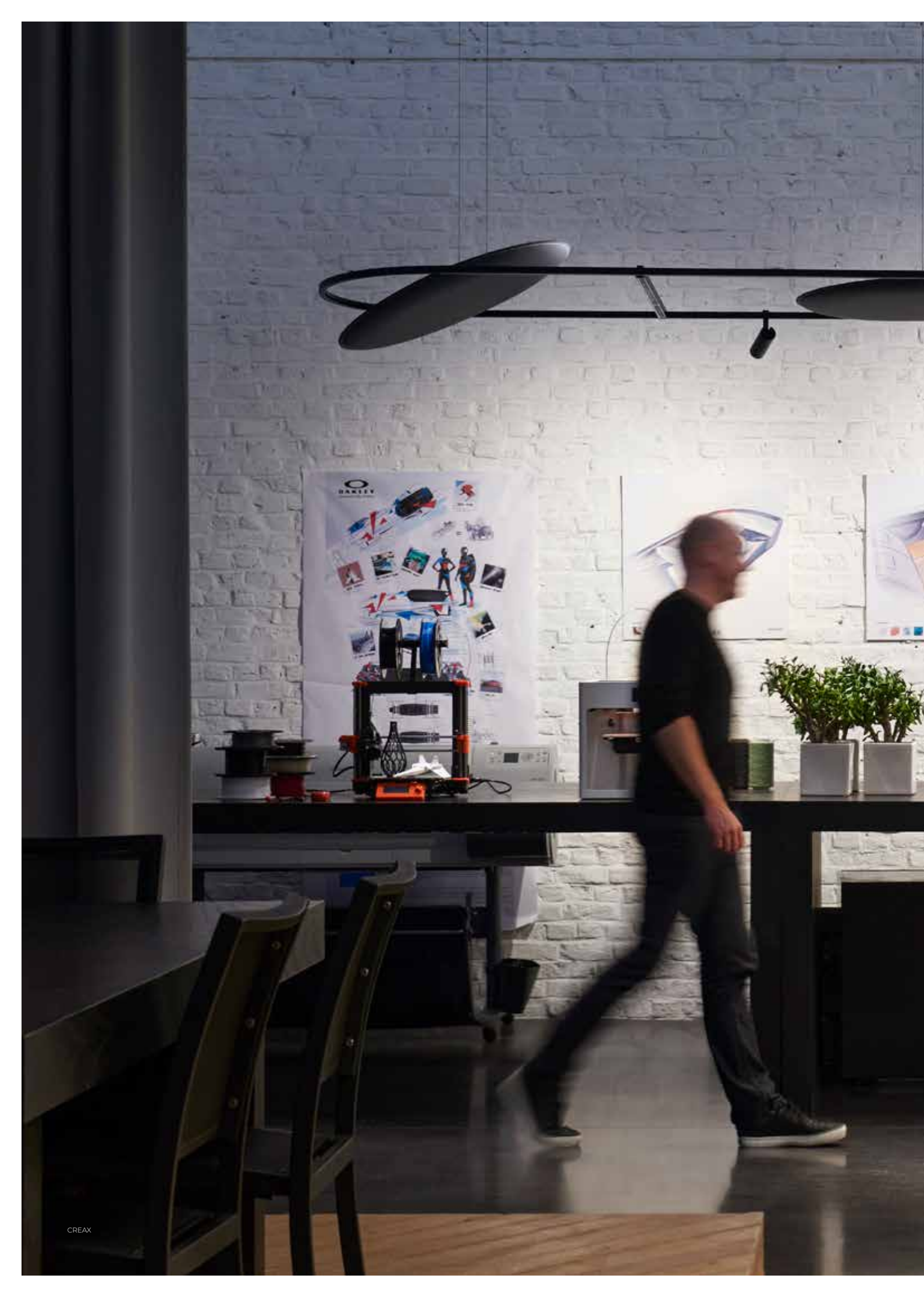



Don't be a pawn in someone else's game



# LASS-OH!

Lass-Oh! glides through the room as a snake sliding through the greensward, showing off its slim cylindrical contour in combination with the miniature LED clusters hidden inside its body. The variety in shape - straight lines or curved squares and rectangles - in combination with the optional shades make of Lass-Oh! a very decorative lighting solution. Nevertheless, Lass-Oh! can easily be hung in every residential, retail or office project thanks to its low-glare LED dots that are hidden away into the profile.

[www.deltalight.us/lass-oh](http://www.deltalight.us/lass-oh)  
[www.deltalight.ca/lass-oh](http://www.deltalight.ca/lass-oh)



INTERIOR CEILING

## FAMILY OVERVIEW

### CHOOSE YOUR FINISH



Black / Gold Colored

### CHOOSE YOUR SHAPE

Rectangular / Linear

### CHOOSE YOUR POWER

Rectangular

4 x 6W – 610lm up to 6 x 6W – 610lm

Linear

2 x 6W – 610lm up to 6 x 6W – 610lm

### CHOOSE YOUR COLOR TEMPERATURE

2700K / 3000K / 3500K

### OPTICS

34°

### CHOOSE YOUR CONTROL

0-10V / Phase Dimming /  
Lutron ECO / Lutron 2-Wire

### CHOOSE YOUR ACCESSORY

Add Jiha! flaps for  
an extra decorative touch

### FIXATION

Coverplate

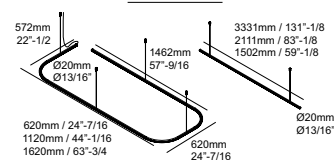











CASTEELKEN

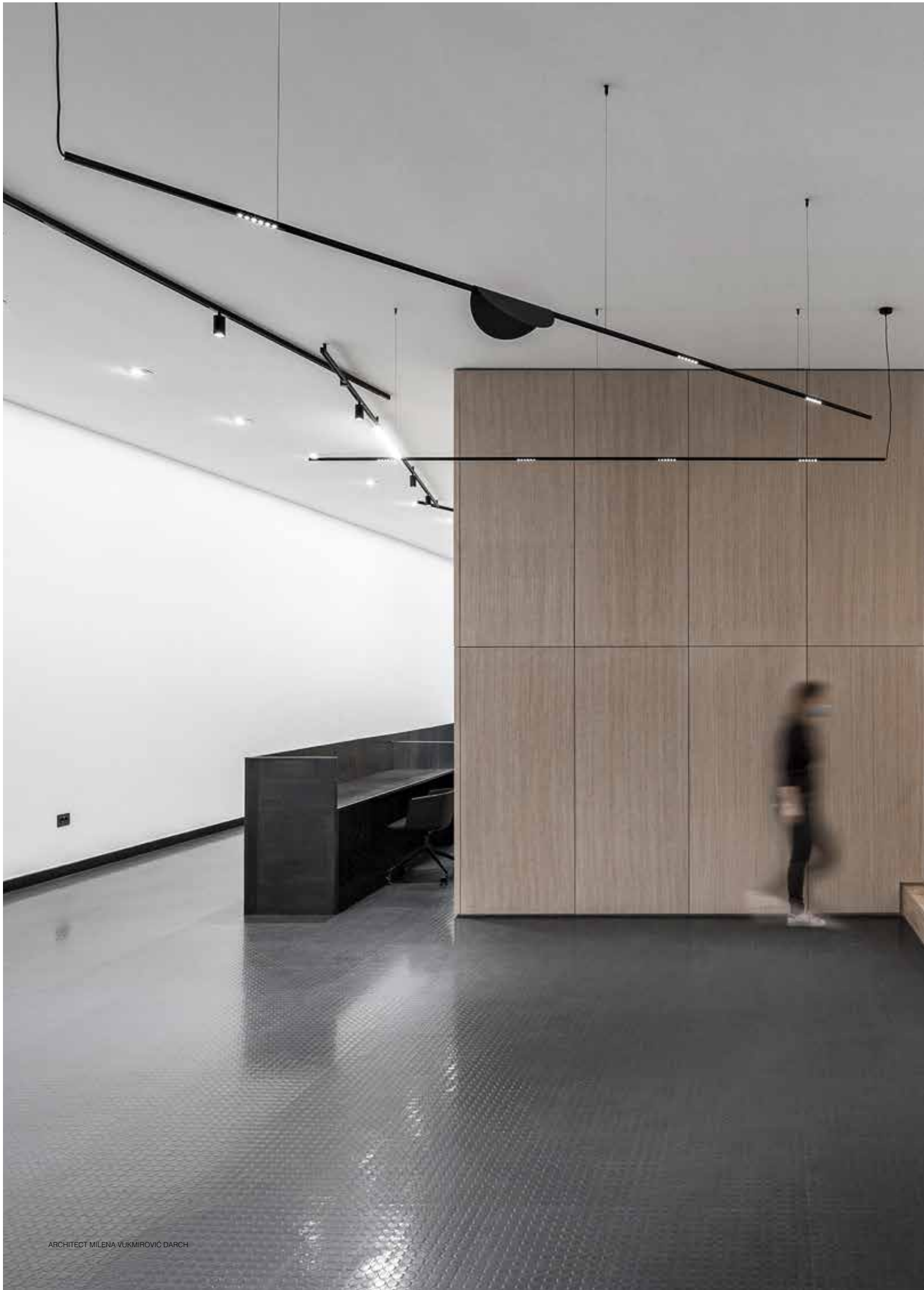

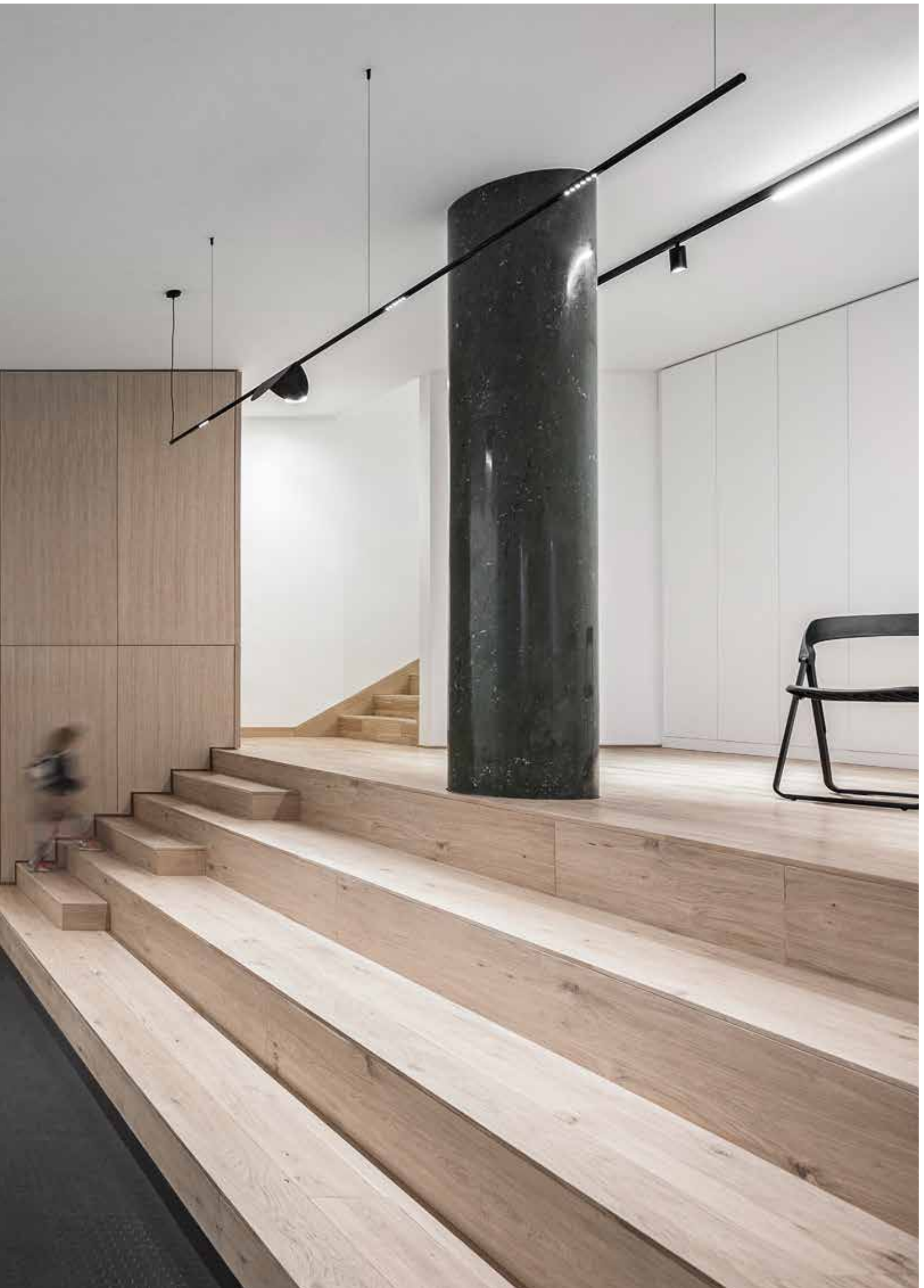



# INFORM FAMILY

## **A WORKING TOOL**

The Inform family is an extensive range of linear and curved lighting solutions, designed to be used in applications that include task areas, like landscape offices, meeting rooms, reception desks, home office, ... Areas which need technical architectural lighting at its best: eye for design, eye for the user and eye for performance.

The base of this family is a combination of Delta Light's Melanopic Light Technology (MLT) with high efficient louvre optics.

## **ULTIMATE VISUAL COMFORT**

Different from the fluorescent tubes, a LED array is build up out of multiple LEDs. Therefore, the reflector is designed to perfectly embrace every individual LED module in a way to boost the efficiency of the complete luminaire while maintaining a high level of visual comfort as every LED dot is shielded from being looked into.

# INFORM SQ

## PURE MINIMALISM

Inform SQ breaths refinement in all its aspects. Its slender dimensions of 1" - 28mm by 1" - 28mm weld in seamlessly in any architecture.

By letting the power run over the suspension cables, there is no need for additional supply cables, emphasizing the minimalistic looks of the profile.

The subtle details empower its sublime design: the recessed endcaps with integrated logo, the multiple color combinations, the design of the powerbox in line with the profile design, all of them adding to the pure minimalism where Inform SQ stands for.

## HIGH PERFORMER

Despite its minimalistic design, Inform SQ does not compromise on performance.

With a delivered lumen package downwards of up to 3045lm per meter, Inform SQ is perfect for illuminating task areas like office desks or reception counters.

Within the same dimensions one can also opt for a down-up version of Inform SQ, enhancing the sense of space and creating a uniform glow on both vertical as horizontal surfaces, which leads to a reduced contrast and relaxes the eye.

## HUMAN IN THE CENTER

The human aspect is the central topic for Inform SQ. It offers state of the art LEDs that help control the human circadian rhythm via a unique spectrum meant to stimulate activity. The high quality LEDs provide a very natural white color with a higher amount of energy in the cyan region, helping you to be active during the day and encourage sleep at night.

[www.deltalight.us/inform-sq](http://www.deltalight.us/inform-sq)  
[www.deltalight.ca/inform-sq](http://www.deltalight.ca/inform-sq)

## INFORM SQ

### CHOOSE YOUR FINISH



Black-Black, Black - Matt Gold,  
White-Black or White-White

### CHOOSE YOUR INSTALLATION

Surface mounted (down)  
Suspended (down or down-up)

### CHOOSE YOUR LENGTH

Length 56"-11/16 - 1400mm  
78"-3/4 - 2000mm  
111" - 2820mm

Down

10W up to 51W - 1700lm up to 8800lm

Up

14W up to 27W - 2400 up to 4900lm

Melanopic Light Technology

UGR <19

### CHOOSE YOUR COLOR TEMPERATURE

3000K / 3500K

### FIXATION

Coverplate

28mm  
1"-1/8

1440mm / 56"-11/16  
2000mm / 78"-3/4  
2820mm / 111"



# INFORM R

PATENTED

## CREATIVE FREEDOM

Who says light for the workplace needs to be boring? Inform R enables you to bring a touch of creativity into the clean and straight lines of the contemporary office environment.

Inform R is a product with an atypical shape, but still compliant with the EN 12464, the standard for office lighting.

[www.deltalight.us/inform-r](http://www.deltalight.us/inform-r)  
[www.deltalight.ca/inform-r](http://www.deltalight.ca/inform-r)







**INFORM R**

**CHOOSE YOUR FINISH**



Black-Black, Black - Matt Gold,  
Flemish Gold - Black  
White-Black or White-White

**CHOOSE YOUR INSTALLATION**

Surface mounted (down)  
Suspended (down or down-up)

**CHOOSE YOUR POWER**

Down  
24W - 3500lm

Up  
12W - 1800lm

UGR <19

**CHOOSE YOUR COLOR TEMPERATURE**

3000K / 3500K

**FIXATION**

Coverplate

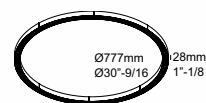





# CONFORM

Its elegant design with multiple color combinations, its specific sun-mimicking spectrum, its low UGR, its well balanced down-up ratio...we do not exaggerate: Conform is the goddess of office lighting!

Conform is designed around the light. It not only perfectly embraces the light source, it reinforces it in multiple aspects. Conform uses Delta Light's Natural Light Technology (NLT), state of the art LEDs with a spectrum that very closely matches that of the sun. That includes a broader spectrum, which is preferable for the human eye and brings out the vibrant colors, and an enhanced cyan energy, boosting the human activity.

Design by **DEAN SKIRA** & Delta Light

[www.deltalight.us/conform](http://www.deltalight.us/conform)  
[www.deltalight.ca/conform](http://www.deltalight.ca/conform)

As so, the LEDs used in Conform help control the human circadian rhythm. To further stimulate the human well-being, Conform uses a down-up ratio of 55% to 45%, as a combination of direct and indirect light is recommended against eye strain. Every downwards facing LED is perfectly embraced by specially designed reflectors, resulting in a beam angle of 67° that enlightens the task area but has no direct impact on the eye. Additionally, the uplight is being spread over the room to enhance the spacial effect and to create a uniform lighting scheme, thanks to the inhouse designed lens extrusion to create a wide batwing beam angle without an intense peak in the centre.

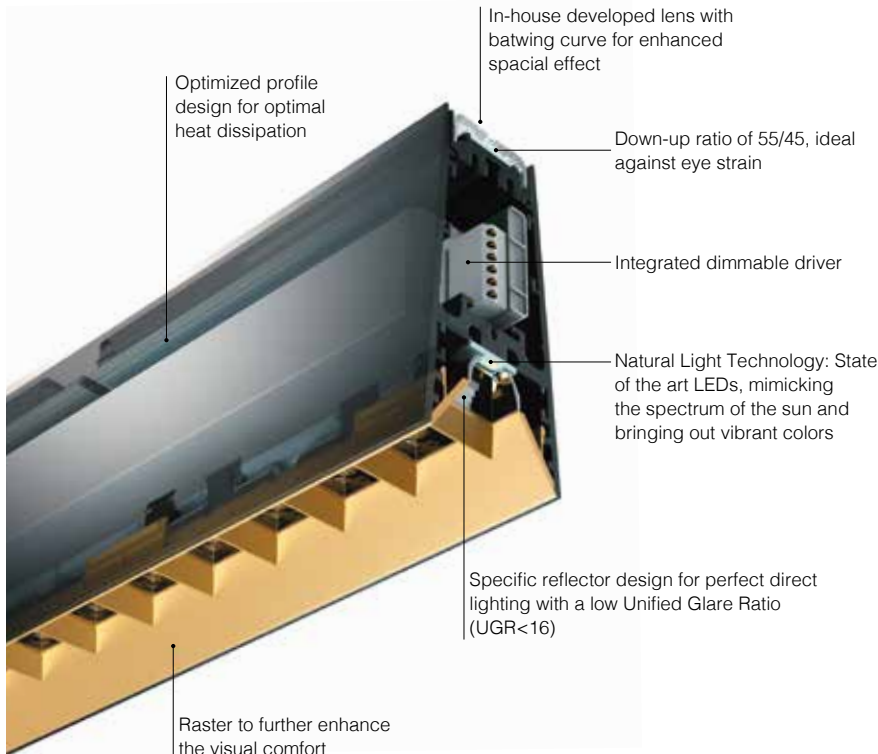

Profile-raster color combinations:  
 Black-Black, Black-Matt Gold,  
 White-Black

## FAMILY OVERVIEW

### CHOOSE YOUR FINISH



Black-Black,  
 Black-Matt Gold or White-Black

### CHOOSE YOUR LENGTH & POWER

58"-9/16 - 1488 mm  
 Down 22W - 2400lm  
 Up 17W - 1500lm

80"-5/16 - 2040 mm  
 Down 31W - 3300lm  
 Up 24W - 2100lm

112"-15/16 - 2868 mm  
 Down 44W - 4700lm  
 Up 34W - 3000lm

Natural Light Technology

UGR <16

### CHOOSE YOUR COLOR TEMPERATURE

3000K / 3500K

### CHOOSE YOUR CONTROL

0-10V / Lutron Eco

### FIXATION

Coverplate

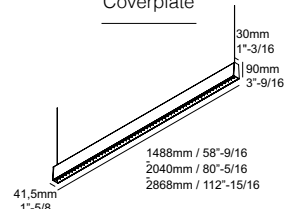











# ONE AND ONLY

A peculiar profile, both functional as decorative. The design of the body allows you to have up to 5 lines of light out of 1 profile, 3 for direct and 2 for indirect lighting. The soft glow of the light along the sides of the profile makes the One-And-Only float through the air, a powerful blend of light for an eye-catching look.

[www.deltalight.us/one-and-only](http://www.deltalight.us/one-and-only)  
[www.deltalight.ca/one-and-only](http://www.deltalight.ca/one-and-only)

## FAMILY OVERVIEW

### CHOOSE YOUR FINISH



Black / Gold Colored / White

### CHOOSE YOUR LENGTH & POWER

46"-1/2 - 1181mm

3700lm / 35W down - 2400lm / 23W up

74"-7/8 - 1902mm

5900lm / 56W down - 4000lm / 37W up

### CHOOSE YOUR COLOR TEMPERATURE

3000K / 3500K

### CHOOSE YOUR CONTROL

0-10V Dim

### FIXATION

Coverplate

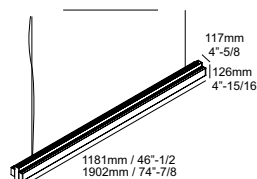

Find the other members of this family **PROFILES**





I-COR (INTERIOR CONCEPT STORE ROESELARE) WWW.I-COR.BE



**FAMILY OVERVIEW****CHOOSE YOUR FINISH**

Black / White

Finish off with a

Clear, Amber or Opal White bowl glass

**POWER**

7,1W - 810lm

**CHOOSE YOUR COLOR TEMPERATURE**

2700K / 3000K

**CONTROL**

Phase Dimming

**CHOOSE YOUR FIXATION**

Mud Kit / Coverplate

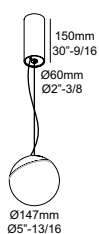

# GIBBO

## FAMILY

Gibbo is a decorative pendant with a base positioned under a predefined angle, as such the globe appears to be rolling away. The glass is handblown and is available in transparent, opal or amber shades. The golden brown color gives the Gibbo a warm presence, which makes it attractive in compositions above tables and in interiors with warm accents and materials. The base of Gibbo is available in black or white.

[www.deltalight.us/gibbo](http://www.deltalight.us/gibbo)  
[www.deltalight.ca/gibbo](http://www.deltalight.ca/gibbo)



ARCHITECT TOM LIEFMAN / GOLFCLUB DE KLUIZEN



ARCHITECT LIEVEN MUSSCHOOT

# MILES

Miles is pure eye-candy.

A collection of 4 purely handcrafted glass shapes, each in 4 different colors (pink, amber, smoke or mist), each recognizable yet unique in all respects.

A family of suspensions that play on the visual contrast between the colored and white blown glass, combined with different shapes and colors, also ideal for multiple compositions.

All shapes and finishes are inspired by the interplay of opacity, translucency and transparency. Its translucent or milky forms and dynamic light offer a countless number of scenarios.

When switched off its transparency makes MILES almost disappear.

When switched on they provide a cozy and stylish luminous presence, stimulating senses and perceptions.

[www.deltalight.us/miles](http://www.deltalight.us/miles)

[www.deltalight.ca/miles](http://www.deltalight.ca/miles)







Miles is a family of figures differing in form, size and color, spreading a calm, intimate atmosphere.  
The 4 Miles shapes each come in 2 different versions, either with an invisible LED source, or with E26 enabling you to opt for a classic or more expressive bulb.

The Miles shapes are designed to glow in clusters. Hung at various lengths, they create a majestic and sensual centerpiece wherever they are applied. A luxurious installation of clear and colorful glass shades.

A set of decorative tubes in black and gold finishing is available to further upgrade your presentation. These elegant casings add sophistication and style, at the same time distinguishing the magical sphere of the glass from the technical components on top.

All Miles suspensions start from the same ribbed top, with a smooth transition to its four shapes. Each shape has its own unique character, yet every time starting from the same angle, ensuring a harmonious whole when used in a configuration.

**FAMILY OVERVIEW**

**CHOOSE YOUR FINISH**



Amber / Mist / Pink / Smoke

**CHOOSE YOUR SHAPE**

From long tubular to flat disc

**CHOOSE YOUR LIGHT SOURCE**

LED  
7,1W – 780lm  
—  
E26

**CHOOSE YOUR ACCESSORY**

Finish of with a Black or Brass tube

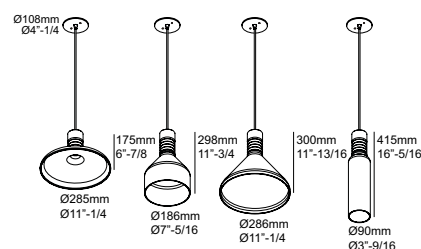







SOIREE

The Soiree range was designed to be voluminous, lightweight and transparent. Its sophisticated form creates a dense and decorative effect, filled with a warm light. The interaction between the pure circular and rectangular forms, with the warm light sources and the symmetric configurations, triggers a dynamic tension. The Soiree takes its inspiration from many angles. From the play of light and shadow in architecture, to natural light effects, the shape of everyday objects and sculptural art. The result is a nest of light, made of circles or rectangles, both structural and decorative, generating a seductive luminous effect. Even when not turned on, they bring texture and character to rooms, defining different areas with small and large contemporary pendants.

The cluster of black circles are in contrast to the classic spherical mood of the inside light source, making the round Soiree a unique object. Either with a bulb or milky-glass light at its centre, the Soiree presents itself like a luminous star wrapped by concentric overlapping orbits. The light adds a warm glow to its sculptural cage, resulting in a unique dégradé effect, peeping through the circles to spread softly into space.

The Soiree is an entire family of versatile suspensions for large or small spaces. Both the round and rectangular versions come in multiple sizes and 2 colors – black or the unique Delta Light Flemish Gold. In both shapes you have the flexibility to choose for a milky-glass sphere at its centre, or to opt for an E26 bulb of your preference. The blown glass diffuser in the centre offers subtle nuances thanks to its satin-like finish, in contrast with its more expressive outer cage.

[www.deltalight.us/soiree](http://www.deltalight.us/soiree)  
[www.deltalight.ca/soiree](http://www.deltalight.ca/soiree)

**FAMILY OVERVIEW**

**CHOOSE YOUR FINISH**



Black / Flemish Gold

**LIGHT SOURCE**

E26

**CHOOSE YOUR LIGHT EFFECT**

Open / Opal glass

**CHOOSE YOUR SHAPE**

Round / Rectangular

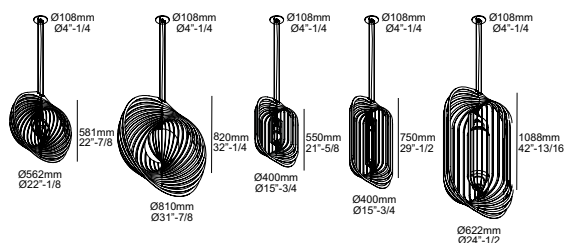

The rectangular Soiree suspensions embody flexibility, clarity and strength, resulting into a powerful object with a vivid personality. When viewed from different sides, the circular or rectangular pattern changes at every angle.

The Soiree lighting object succeeds effortlessly in putting the observer on the wrong foot with its surprising volume. Everywhere this eye-catcher is given space, it opens up a game of stylised forms and warm light. No matter how you look at it, stylish added value is guaranteed.





One Soiree suspension makes a bold statement by itself, when combined to form a cluster of pendants it can create a more monumental installation. In any application, the Soiree is ready for different combinations thanks to its multitude in shapes, colors and sizes. Either as a rhythmical counterpoint against a more minimalistic backdrop, or in a repetitive set-up above a long counter or room of tables... The Soiree enhances rooms with its unique character, making both residential and commercial settings a bit more magical.









# ZOOVER

Zoover pretends to be heavy seen its size, nevertheless it looks very lightweight when hung into the room. Designed as a shallow dome, Zoover hides away a circle of light, giving it different looks depending on the point of view. Looking at it from aside, the thermoformed shell has a very neutral appearance. Only when lowering the viewpoint, more and more details catch the eye, as the diffuse light illuminates the inner textures of the scallop. Available in two sizes and two colors for the shade, Zoover adds volume, depth and texture to the room.

[www.deltalight.us/zoover](http://www.deltalight.us/zoover)  
[www.deltalight.ca/zoover](http://www.deltalight.ca/zoover)



**FAMILY OVERVIEW**

**CHOOSE YOUR MATERIAL & COLOR**



Black

PET-felt Light Grey or Dark Grey Dome

**CHOOSE YOUR SIZE**

Ø 47"-1/4 - 1200mm

Ø 55"-1/8 - 1400mm

**POWER**

33,2W - 4820lm

**COLOR TEMPERATURE**

3000K / 3500K

**OPTICS**

Sandblasted

**CHOOSE YOUR CONTROL**

0-10V Dim / Lutron Eco

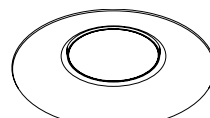

Ø1200mm / Ø47"-1/4  
Ø1400mm / Ø55"-1/8



167mm  
6"-9/16







INTERIOR

**WALL**



# RECESSED

## LOGIC W

P 258

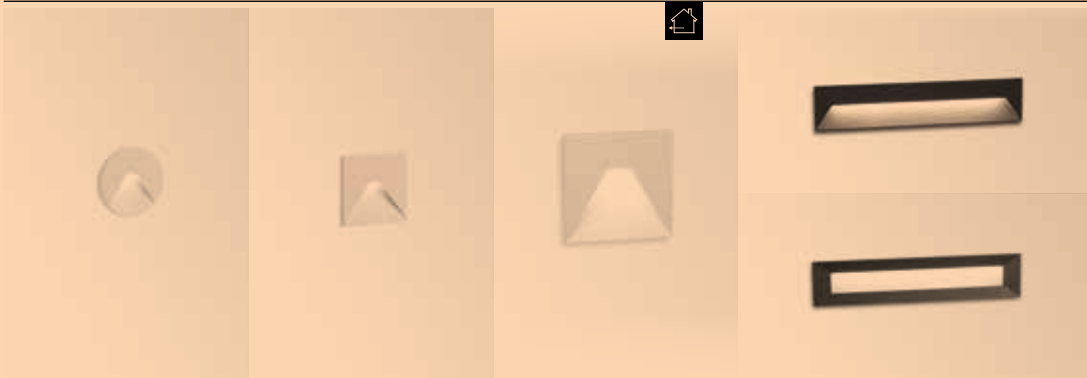

## INLET

P 262



## LEDS C

P 266



## HELI

P 268

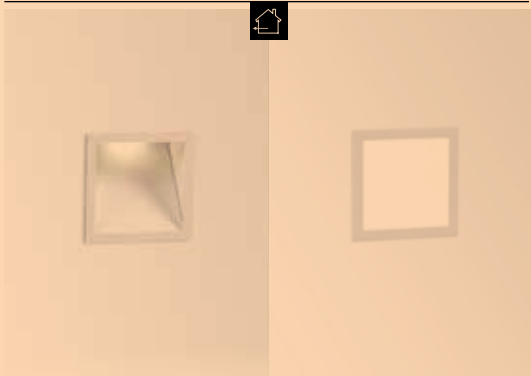



# SURFACE

**MONTUR**  
P 272

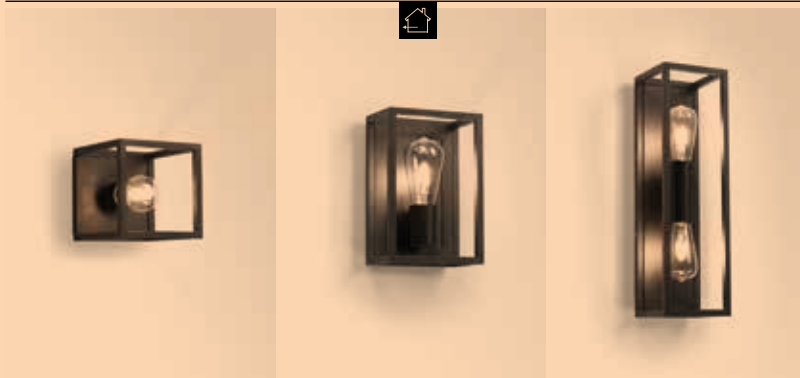

**FORTY-5**  
P 276

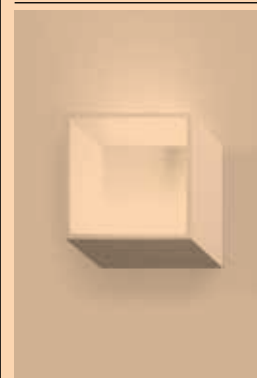

**ORBIT**  
P 280



2 SIZES

**TOPIX**  
P 286



**VISION**  
P 290



**TIGA**  
P 294

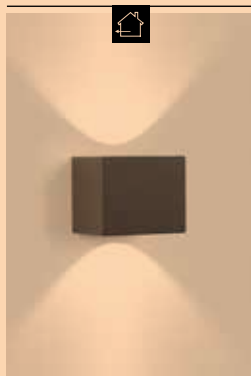

**NEW**  
**BACKSPACE II**  
P 298

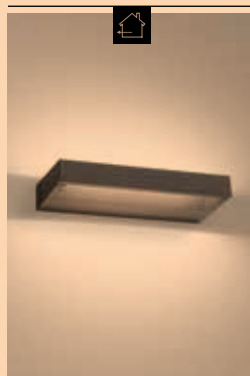

**NEW**  
**WALKER II**  
P 302



# LOGIC W

As a family of guidance lights, Logic W exists out of small and large wall luminaires to be installed slightly above ground level. As such, they provide a soft glow on the floor to guide you along pathways or in corridors, both in- and outdoors.

[www.deltalight.us/logic-w](http://www.deltalight.us/logic-w)  
[www.deltalight.ca/logic-w](http://www.deltalight.ca/logic-w)



## FAMILY OVERVIEW

### CHOOSE YOUR FINISH



Alu Grey / Dark Grey / White

### CHOOSE YOUR SHAPE & SIZE



Round / Square / Rectangular

Small / Large

### COLOR TEMPERATURE

3000K

### CHOOSE YOUR POWER

Small

0,6W - 40lm

Large

7,1W up to 9W - 800 up to 1480lm

### CONTROL

Non Dim

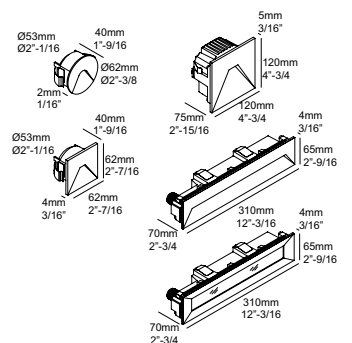

INTERIOR WALL

Find the other members of this family **EXTERIOR WALL**





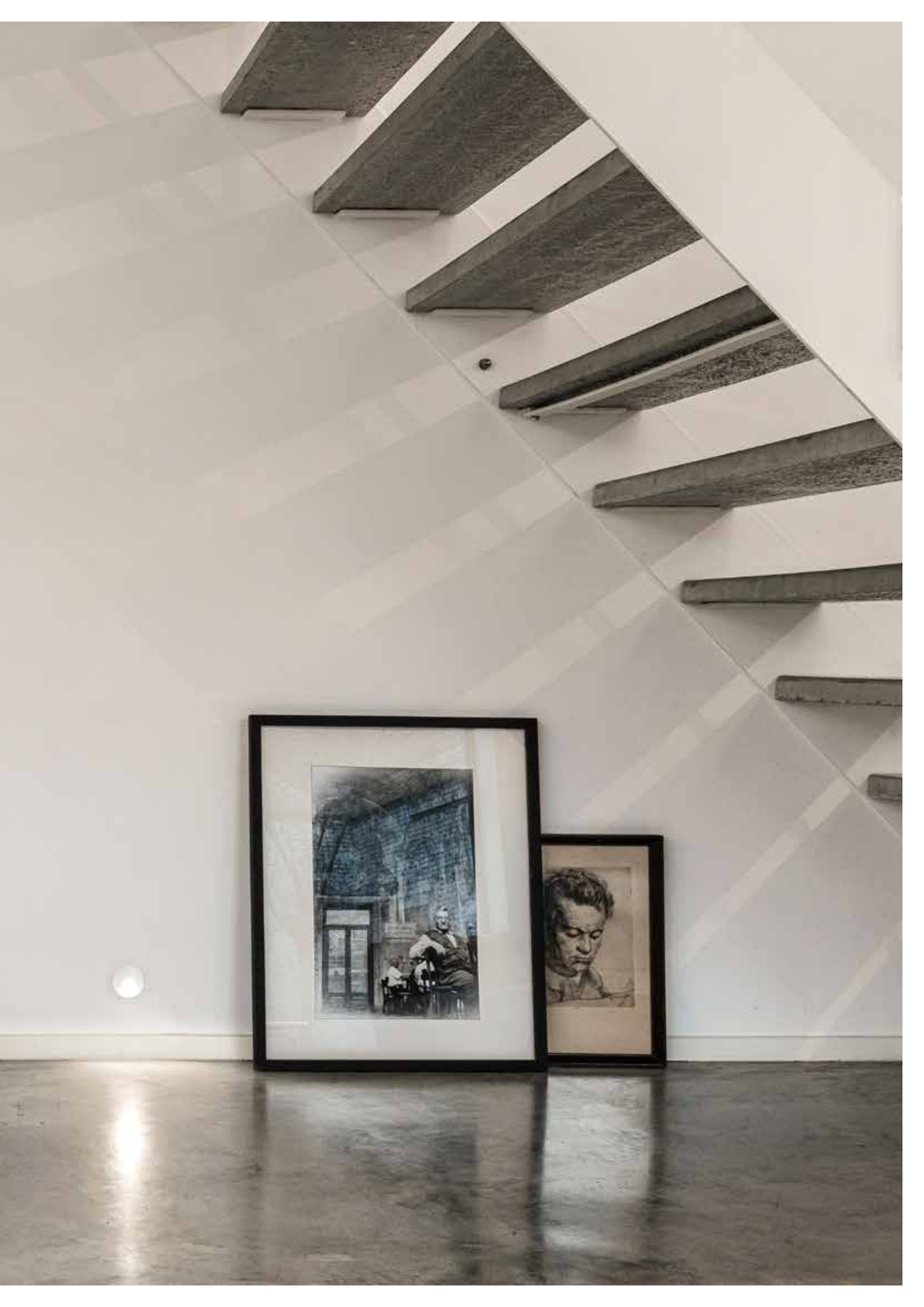

# INLET

Our Inlet is a very popular wall recessed fixture for guidance light in hallways and staircases. A narrow beam of light produces a triangular shaped light effect on the floor. Available with trim or mounted flush in the wall, perfect for usage in residential applications.

[www.deltalight.us/inlet](http://www.deltalight.us/inlet)  
[www.deltalight.ca/inlet](http://www.deltalight.ca/inlet)

## FAMILY OVERVIEW

### CHOOSE YOUR FINISH



Alu Grey / White

### CHOOSE YOUR POWER

1,1W – 130lm

### CHOOSE YOUR COLOR TEMPERATURE

2700K / 3000K

### CHOOSE YOUR INSTALLATION

Protruding or flush with the wall

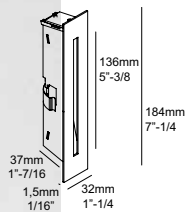









INTERIOR WALL

# LEDS C

This family offers some miniature fixtures that serve as orientation and atmosphere lighting. Available in round and square, these little dots of light are perfect as guidance lights. While Leds C II can be used indoors - for example as safety light in corridors and hallways -, Leds C R ST and Leds Go will guide the way outdoors - along paths and driveways.

[www.deltalight.us/leds-c](http://www.deltalight.us/leds-c)  
[www.deltalight.ca/leds-c](http://www.deltalight.ca/leds-c)

## FAMILY OVERVIEW

### CHOOSE YOUR FINISH



White

### CHOOSE YOUR SHAPE



### POWER

1W - 150lm

### CHOOSE YOUR COLOR TEMPERATURE

2700K / 3000K

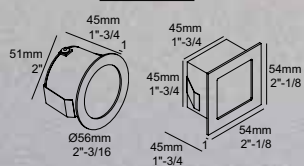

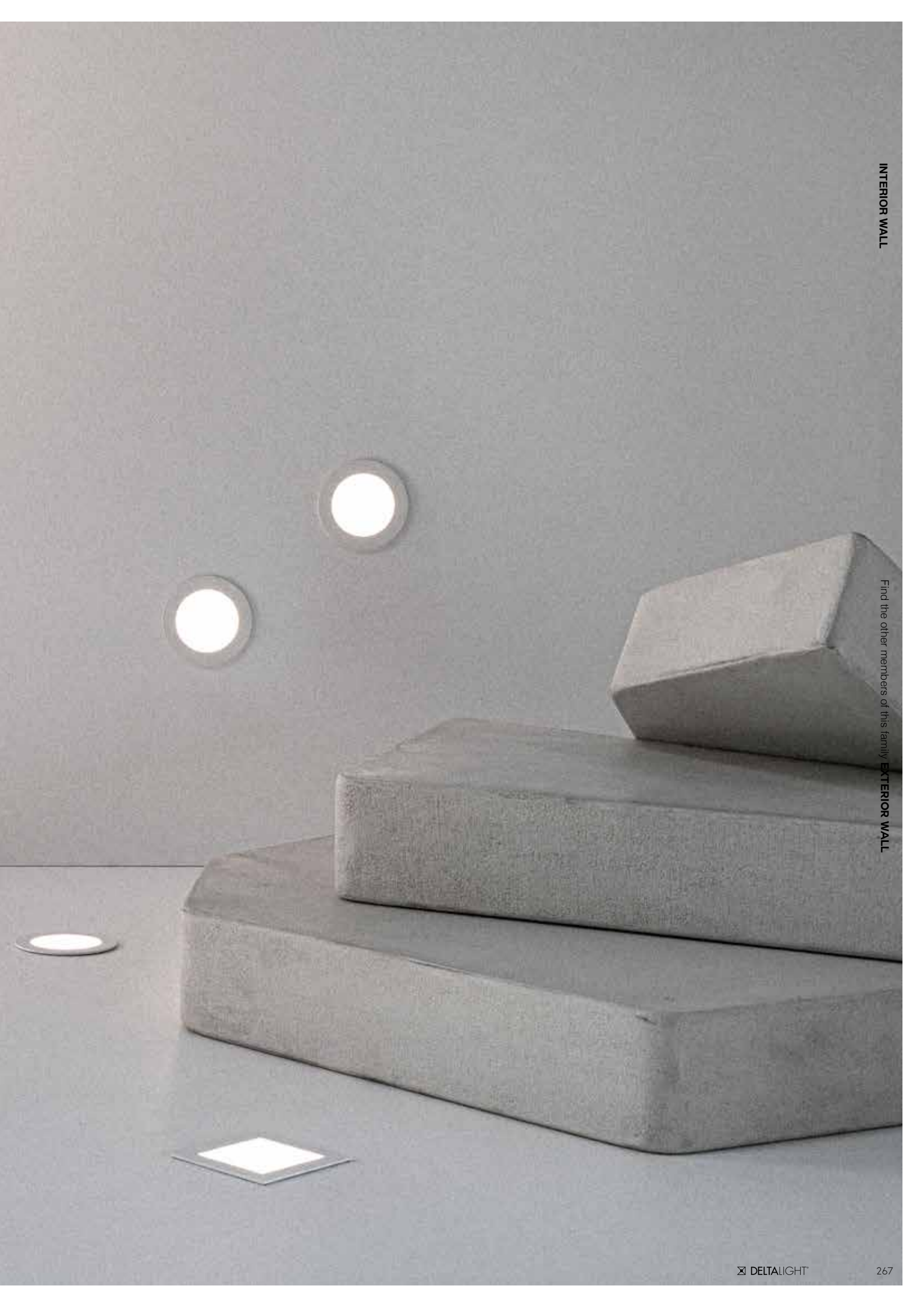

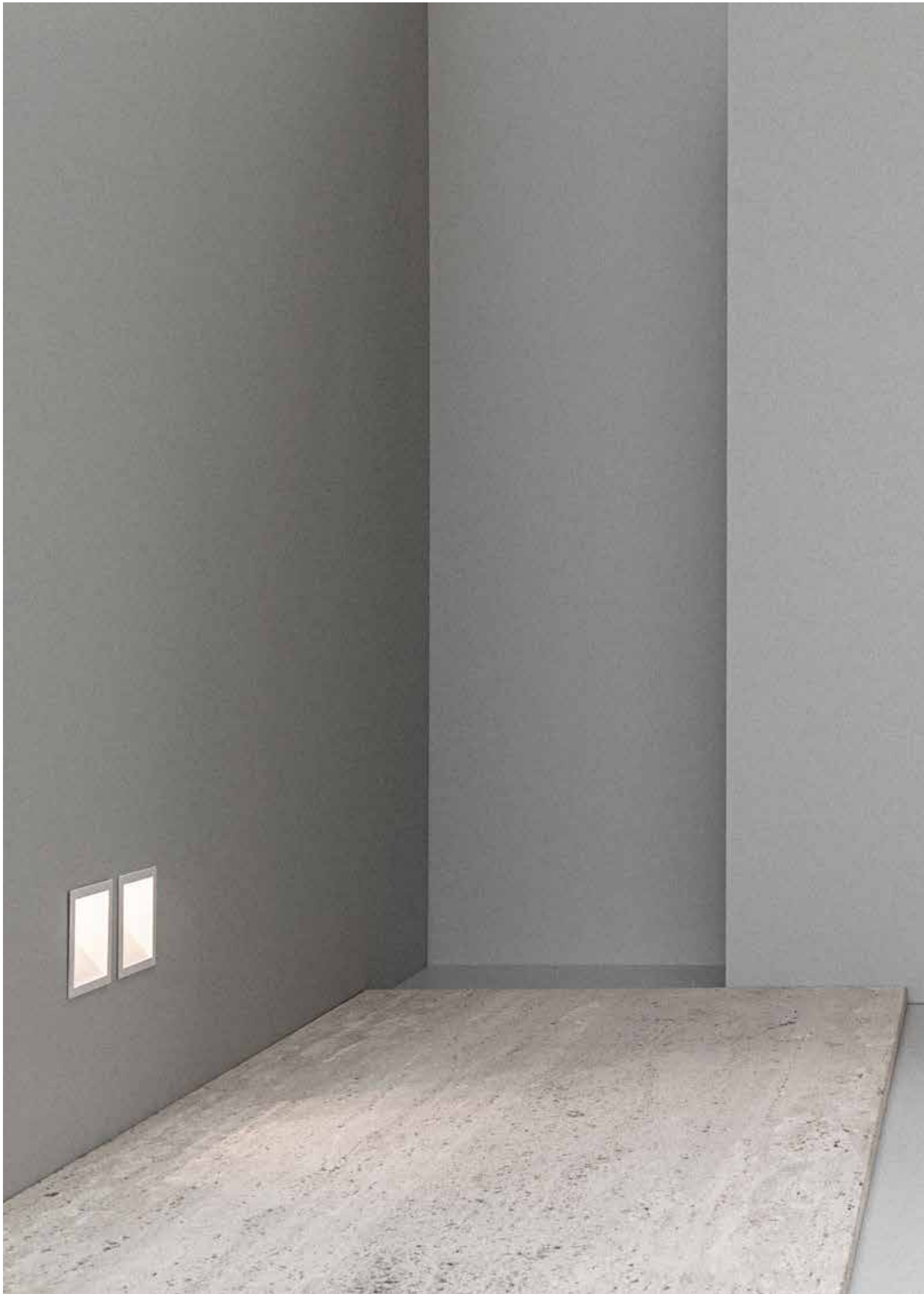



# HELI

As a small wall recessed luminaire, Heli is perfect as a guidance light. Be it in a corridor or as a safety light for the steps of your stairs at night, Heli does the trick. Also outside, Heli X will guide you the way.

[www.deltalight.us/heli](http://www.deltalight.us/heli)  
[www.deltalight.ca/heli](http://www.deltalight.ca/heli)

## FAMILY OVERVIEW

### CHOOSE YOUR FINISH



Alu Grey / Dark Grey / White

### POWER

1,1W - 130lm

### CHOOSE YOUR COLOR TEMPERATURE

3000K / 4000K

### CHOOSE YOUR VERSION

With or without plexi

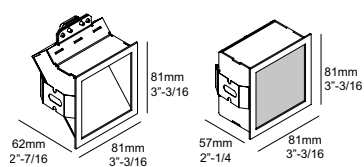







# MONTUR

With Montur we offer a highly original interpretation of an archetypical concept: a light source that is contained within the framing of a 3D square or rectangular shape. The Montur is available in indoor versions, as a ground, wall or ceiling fixture, with LED clusters or filament-LED lamps with a rustic look. The series integrates beautifully in both country-classic and contemporary homes, and is suitable for hotels and public buildings as well.

The Montur not only breathes new life into a classic concept, it also adds a detailed element of refinement. The sharply profiled framing in aluminium is utterly devoid of welding seams. For both the indoor and outdoor versions, there is a choice of finishing with either hand pressed transparent or opal glass. The opal glass version contains a milky, cone shaped core, with a transparent glass surface, creating a pleasantly diffused light that gives the lamp extra cachet. The indoor version of the Montur is also available as an open cube, with one or two bulbs. By using them as outdoor fixtures, you can extend your lighting style into the garden or parking area.

[www.deltalight.us/montur](http://www.deltalight.us/montur)  
[www.deltalight.ca/montur](http://www.deltalight.ca/montur)



**FAMILY OVERVIEW**

**CHOOSE YOUR FINISH**



Black / Flemish Bronze / Flemish Gold

**CHOOSE YOUR SHAPE & SIZE**



Square / Rectangular  
Small / Medium / Large

**CHOOSE YOUR LIGHT SOURCE**

Integrated LED / E26

**CHOOSE YOUR POWER**

6,3W – 960lm

**CHOOSE YOUR COLOR TEMPERATURE**

2700K / 3000K

**CONTROL**

Non Dim

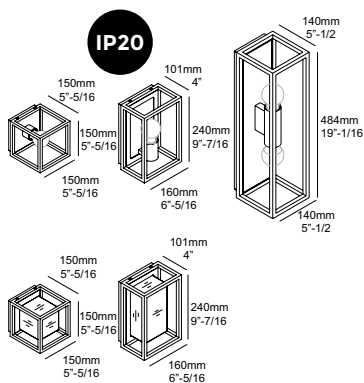

Find the other members of this family **EXTERIOR WALL / FLOOR**



ARCHITECTS: THONE ARCHITECTUUR  
INTERIOR DESIGN: TIM VAN STEENBERGEN







# FORTY-5

Forty-5 is a wall-mounted architectural eye-catcher. It is hard to describe this light fitting either in words or in images. Call it the three dimensional development of a cube on paper: from reality to abstraction and back. A cube on paper consists of two overlapping squares, with the corners joined by four lines at 45 degrees; hence the name.

Forty-5 puts the observer to the test and gives a playful touch to the wall. Ideal in the home or as a background for receptions and entrance halls. The fitting is available in two versions each forming the mirror image of the other. Add an extra dimension with installations that play with a downlighter and an uplighter.

[www.deltalight.us/forty-5](http://www.deltalight.us/forty-5)  
[www.deltalight.ca/forty-5](http://www.deltalight.ca/forty-5)



## FAMILY OVERVIEW

### CHOOSE YOUR FINISH

○  
White

**POWER**  
3W – 520lm

**CHOOSE YOUR VERSION**  
Left / Right

**COLOR TEMPERATURE**  
3000K

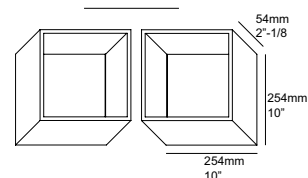



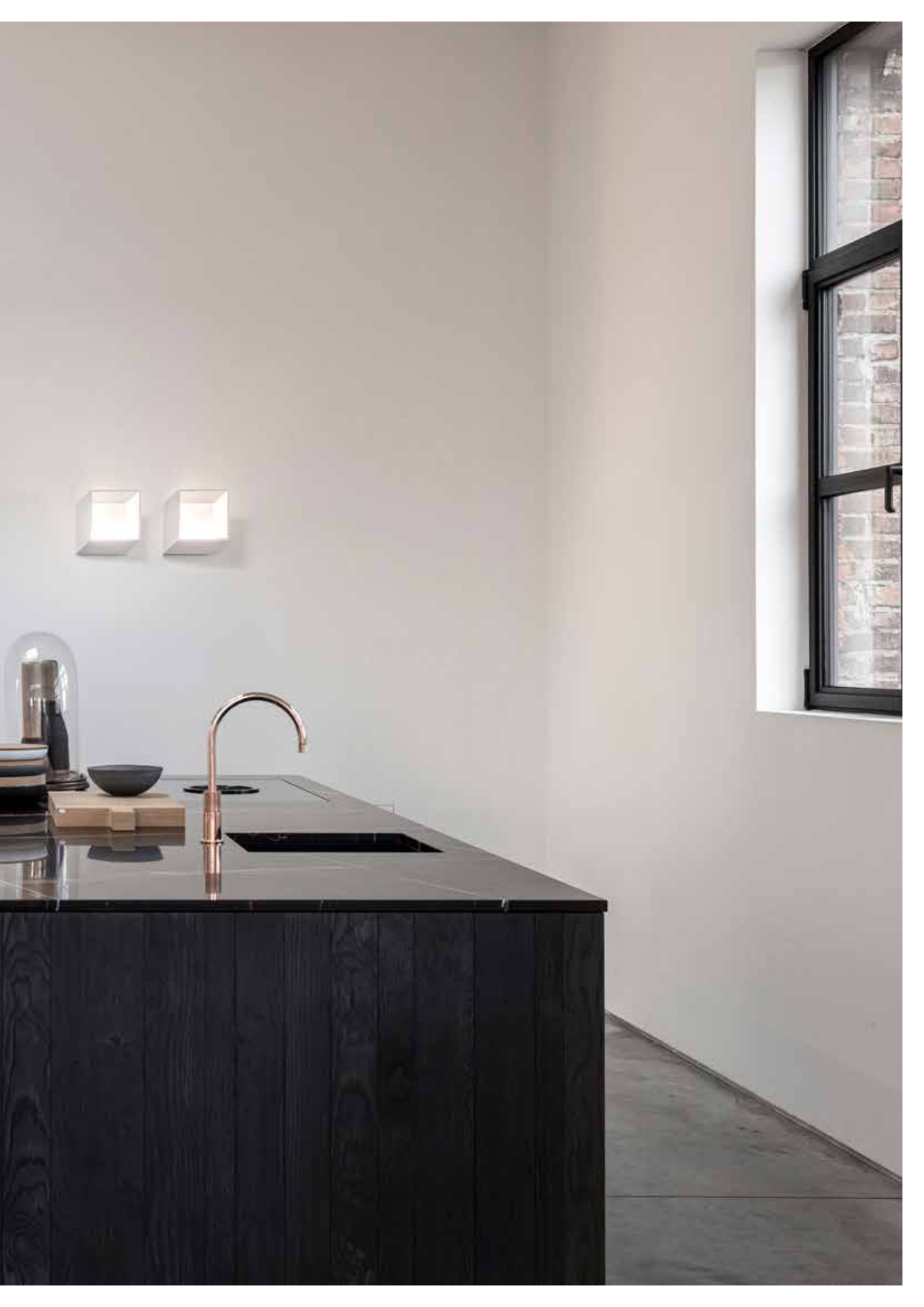

—AWARD—  
DESIGN PLUS  
light+building

# ORBIT

As a Design Plus Award winner in 2000, the Orbit has been a favorite in the wall mounted range of Delta Light for many years. Orbit combines a couple of LEDs with a lens for up- and downlight, which results in a distinctive light pattern on the wall. Finished in either standard lacquered finish or with the typical Punk look.

[www.deltalight.us/orbit](http://www.deltalight.us/orbit)  
[www.deltalight.ca/orbit](http://www.deltalight.ca/orbit)



**FAMILY OVERVIEW**

**CHOOSE YOUR FINISH**



Black-Gold Matt /  
Black Pure-Gold Matt / Gold Colored-Black /  
White

**CHOOSE YOUR FINISH**

Smooth / Punked spikes

**LIGHT & POWER**

LED  
6,4W – 620lm

**CHOOSE YOUR COLOR TEMPERATURE**

2700K / 3000K / 3500K

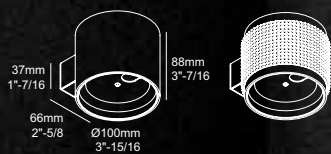









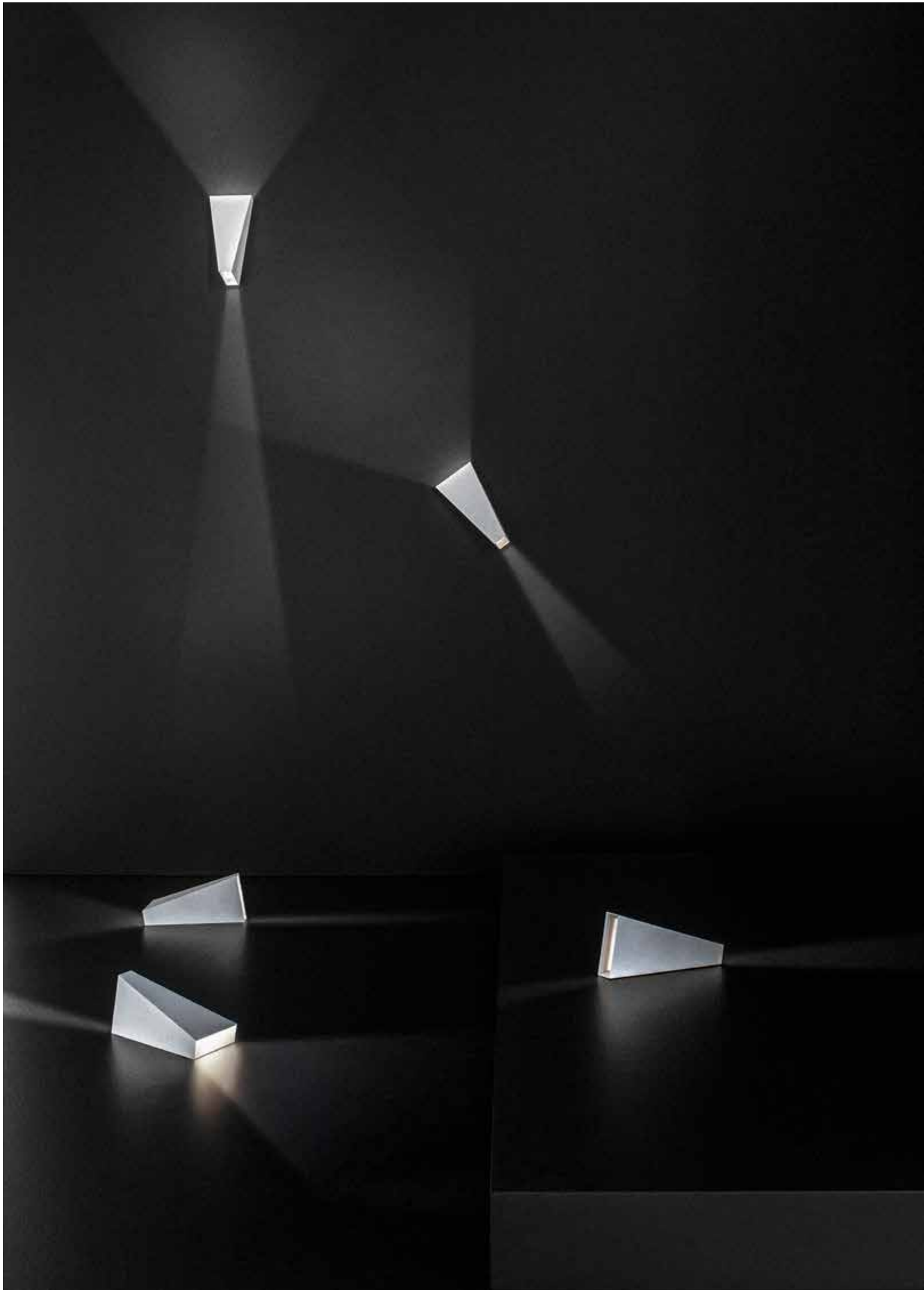

# TOPIX

This multi award-winning luminaire ensures a playful effect and offers a lot of freedom. On its own, Topix wows you with its peculiar yet attractive design, when put together, you can create artistic clusters of light. Topix comes for in- and outdoors, giving you the opportunity to make your façade stand out.

[www.deltalight.us/topix](http://www.deltalight.us/topix)  
[www.deltalight.ca/topix](http://www.deltalight.ca/topix)

INTERIOR WALL

Find the other members of this family **EXTERIOR WALL**

## FAMILY OVERVIEW

### CHOOSE YOUR FINISH



Alu Grey / White

### POWER

2 x 1,1W - 130lm

### CHOOSE YOUR COLOR TEMPERATURE

3000K / 4000K

### CHOOSE YOUR FIXATION

Mud Kit / Concrete Box

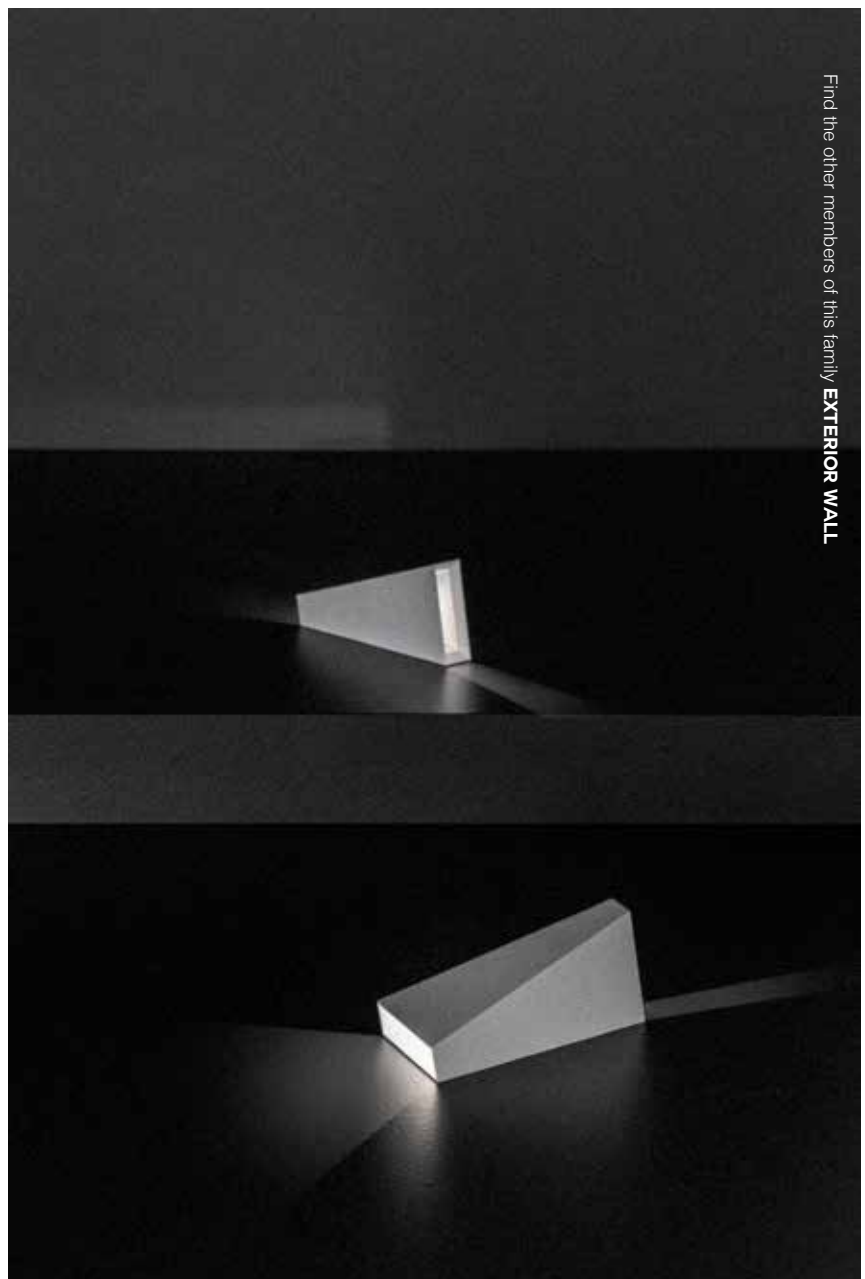
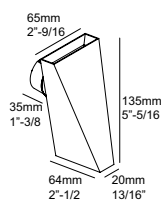

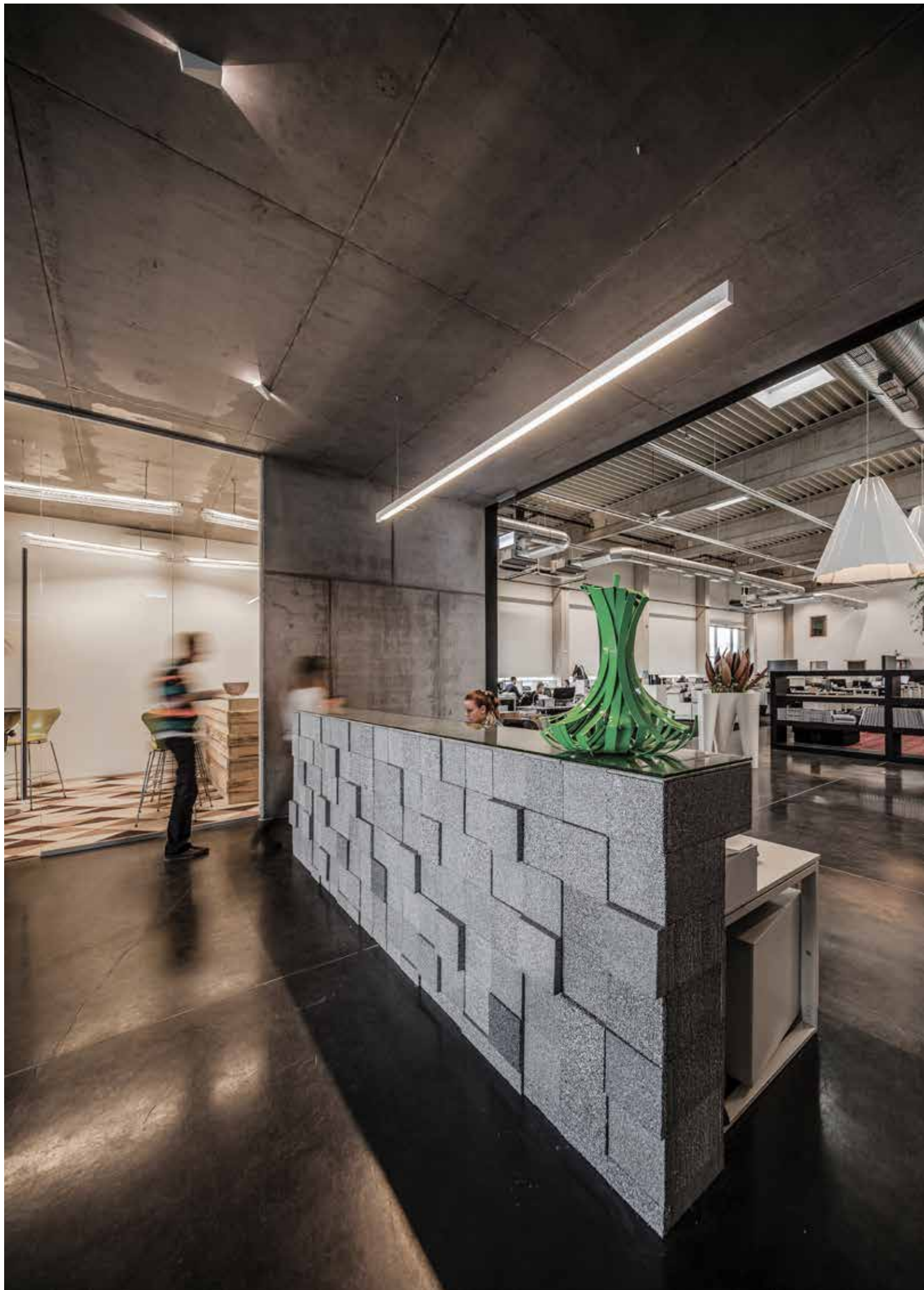







# VISION

Since its launch Vision has already won multiple awards, thanks to its impressive and nicely delineated parabolic light pattern on the wall. Vision thanks its powerful light effect to the combination of LED technology in combination with a lens, giving its unique design and playful light effect.

[www.deltalight.us/vision](http://www.deltalight.us/vision)  
[www.deltalight.ca/vision](http://www.deltalight.ca/vision)



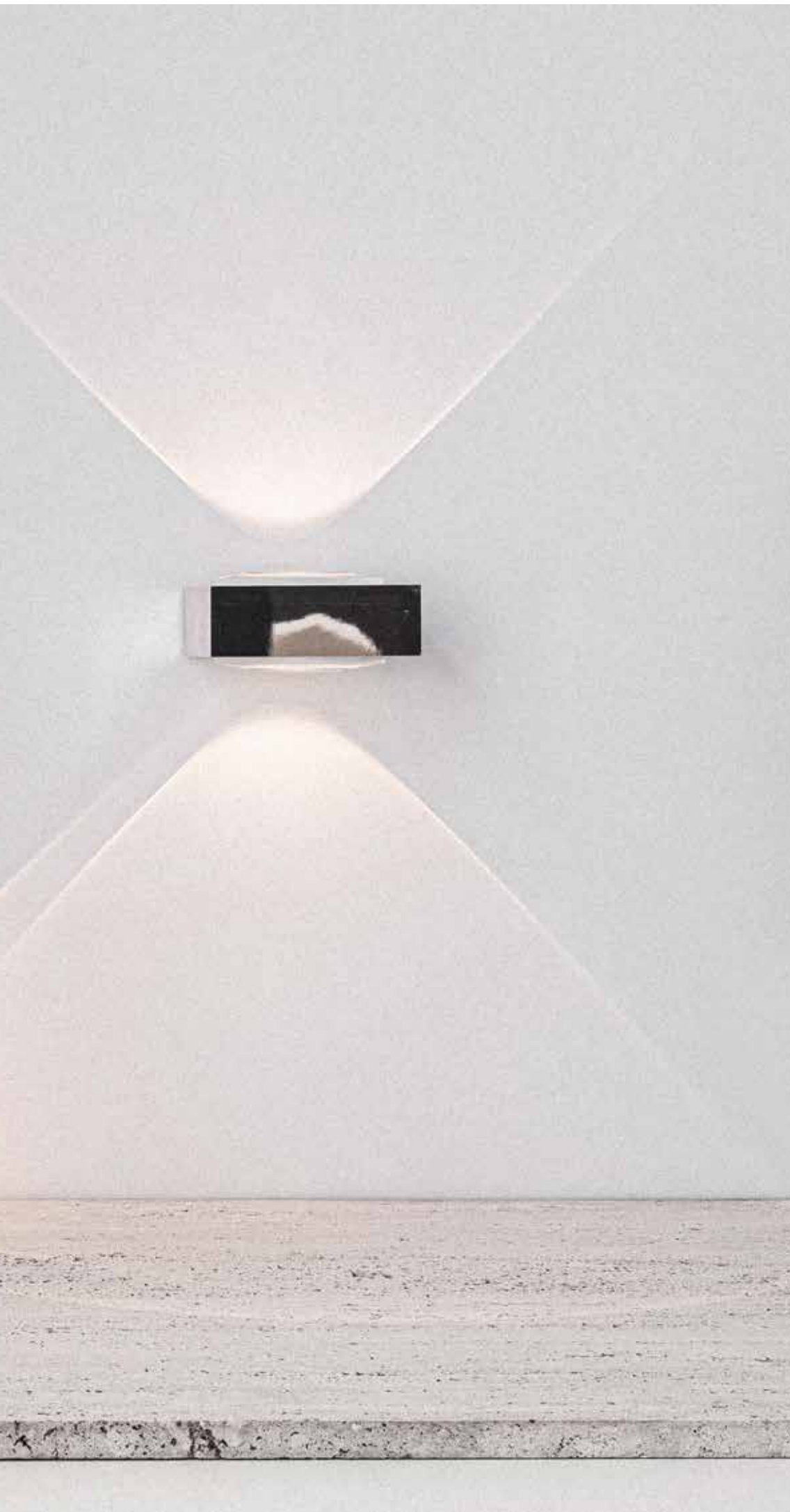

**FAMILY OVERVIEW**

**CHOOSE YOUR FINISH**



White / White-Chrome

**POWER**

2 x 1,4W - 180lm

**CHOOSE YOUR COLOR TEMPERATURE**

2700K / 3000K

**FIXATION**

Mud Kit

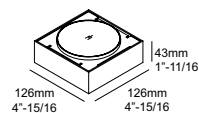



DESIGN STUDIO KEES MARCELIS / PHOTOGRAPHY HANS DE ROOIJ



# TIGA

A medium sized rectangular lighting fixture, delivering a pleasant up and downward light effect on your wall. As a wall mounted luminaire, Tiga is perfect for both residential use or to apply in hotels and restaurants.

Tiga comes as an indoor and outdoor version, perfect to merge your exterior and interior in a similar design language.

[www.deltalight.us/tiga](http://www.deltalight.us/tiga)  
[www.deltalight.ca/tiga](http://www.deltalight.ca/tiga)



**FAMILY OVERVIEW**

**CHOOSE YOUR FINISH**



Alu Grey / Black-Gold Matt /  
Grey Brown / White

**CHOOSE YOUR LIGHT EFFECT**

Wide or small beam for both down & up  
Wide + Small beam combination

**POWER**

7,1W - 810lm

**CHOOSE YOUR COLOR TEMPERATURE**

2700K / 3000K / 3500K

**CHOOSE YOUR CONTROL**

Non Dim

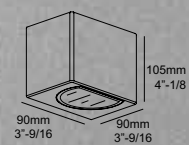



ARCHITECT SALGADA RESTREPO / INTERIOR DESIGN CAMILO SALGADO - HECHIZOO







In many ways, Backspace II is a joy for the eye, be it by its slender design, by its pleasant light effect or by its playful color combinations. Backspace II is designed to create a 2-way light effect on the wall, the choice to install it in a horizontal or vertical way is up to you.

By mounting the light source in the front part of the luminaire, it is perfectly shielded from looking directly into the source.

Backspace II can be used for interior lighting in a white finish. An additional touch of color can be added to the luminaires by opting for an extra golden reflector.

# BACKSPACE II

[www.deltalight.us/backspace-ii](http://www.deltalight.us/backspace-ii)  
[www.deltalight.ca/backspace-ii](http://www.deltalight.ca/backspace-ii)

## FAMILY OVERVIEW

### CHOOSE YOUR FINISH



White



Finish off with a golden reflector

### POWER

10,4W - 1260lm

### CHOOSE YOUR COLOR TEMPERATURE

2700K / 3000K

### CHOOSE YOUR CONTROL

Phase Dimming

### CHOOSE YOUR FIXATION

Mud Kit / Coverplate

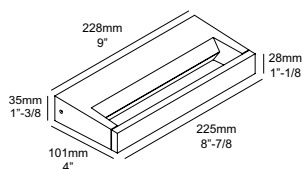

And now we're back, from outer space



CHAMPAGNE  
IN THE  
MORNING  
JELWYN SENATORIO ©





# WALKER II

## SPLIT THE LIGHT

Walker splits the light open. Starting from 1 light source, Walker II is designed to guide the light into two directions to provide a double light effect on the surface below. The light falls on the V-shaped inner part of the luminaire, breaking it open and throwing it to the front- and backside of the luminaire.

Walker II can serve as a guiding light on your wall or pathway, as it comes as a wall luminaire and as a bollard. Different sizes, different heights and multiple color combinations can be combined to your preference to create the perfect setting.

[www.deltalight.us/walker-ii](http://www.deltalight.us/walker-ii)  
[www.deltalight.ca/walker-ii](http://www.deltalight.ca/walker-ii)

## FAMILY OVERVIEW

### CHOOSE YOUR FINISH



Alu Grey / Dark Grey / White / White-Gold colored

### CHOOSE YOUR POWER

5,2W - 672lm / 6,2W - 790lm

### CHOOSE YOUR COLOR TEMPERATURE

2700K / 3000K

### CHOOSE YOUR CONTROL

Non Dim

### FIXATION

Coverplate

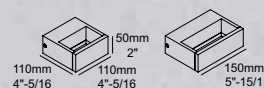











**TRACK**



# TRACK

TRACK

**NEW**

**FRAGMA**  
P 312



1100 - 4600lm

● ● ●  
3 SIZES

The FRAGMA P 312 is a track lighting fixture with a circular, perforated metal housing and a grid of LED chips. It is shown mounted on a black track. A small icon above the product name indicates a dimmable feature.

**NEW**

**MULTINOVA**  
P 318



2150 - 4820lm

● ●  
2 SIZES

The MULTINOVA P 318 features two circular, recessed track lighting fixtures with a thin, dark metal rim. They are shown mounted on a black track. A small icon above the product name indicates a dimmable feature, and a 'PRO' label is present next to it.

**SUPERNOVA XS**  
P 322



1580 - 2600lm

● ●  
2 SIZES

The SUPERNOVA XS P 322 is a track lighting fixture with a large, circular, recessed design and a thin, dark metal rim. It is shown mounted on a black track. A small icon above the product name indicates a dimmable feature.

LUMEN OUTPUT mentioned as indicative reach.

# FRAGMA

No two lighting schemes are identical. Different geometries, different heights, different needs, there is more than only one factor that impacts a lighting set-up. The Fragma range easily adapts to any variable influencing the project, thanks to a multitude in optics, lumen packages and dimming possibilities. Its simple design and its circular shape let you use Fragma throughout the project, as it blends in perfectly in any architectural environment, combining clean cut optical performance, light quality and visual comfort.

[www.deltalight.us/fragma-track](http://www.deltalight.us/fragma-track)  
[www.deltalight.ca/fragma-track](http://www.deltalight.ca/fragma-track)



### LED CASSET TECHNOLOGY

Fragma is based on Delta Light's LED Caset technology, which combines multiple LEDs with individual collimator lenses per LED to generate a clean-cut light distribution.

The individual lenses create a multi-layered light distribution to generate a 14° beam angle as standard. Be it for the smaller version or the high-power Fragma, by concentrating the lenses together, the light distribution will be the same thanks to the multi-layering process.

### DIMMING

Our Fragma luminaires can be used for simple switch on-switch off settings, but also come in different dimmable versions, be it 0-10V, Phase Dimming, with on-board potentiometer.

0-10V dimmable Fragma spots allow for simple group dimming on track level, while our other dimmable versions can be used for individual dimming per spot. This going from individual handset dimming with the on-board potentiometer version. All Fragma versions require a 3 phase track. However our on-board dimmable Fragma spots do not need additional dimming wiring within the 3 phase track and in this way offer an easier approach on flexible and individual dimming.

### VISUAL WELLBEING

Light is not only about light effects, it also affects the well-being of the passer-by. Good light quality is of main importance, as it influences the passer-by in an indirect way. CRI 90, good Color Over Angle uniformity and uniform luminance on the emitting surface are some of the characteristics that let Fragma excel in light quality. In a direct way, the passer-by is influenced by the light when directly looking into the light source. To reduce the direct impact on the passer-by, Fragma offers multiple accessories to further improve its visual comfort.

### FAMILY OVERVIEW

#### CHOOSE YOUR FINISH



Black / White

#### CHOOSE YOUR POWER

Ø 4"-3/4 - 120mm / 10,2W - 1100lm

Ø 5"-1/2 - 140mm / 23,1W - 2400lm

Ø 7"-1/2 - 190mm / 38,8W - 4100lm

#### CHOOSE YOUR COLOR TEMPERATURE

3000K / 3500K / 4000K

#### OPTICS

Standard 14°

Interchangeable micro lenses to alter the 14° beam angle to 26° or 47°

Add a light refining accessory: softening lens, linear spread lens, wallwash lens

#### CHOOSE YOUR CONTROL

Non Dim / 0-10V Dim / Potentiometer Dim / Phase Dimming

#### CHOOSE YOUR ACCESSORY

Honeycomb / Raster / Flaps

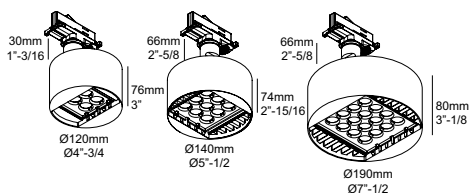







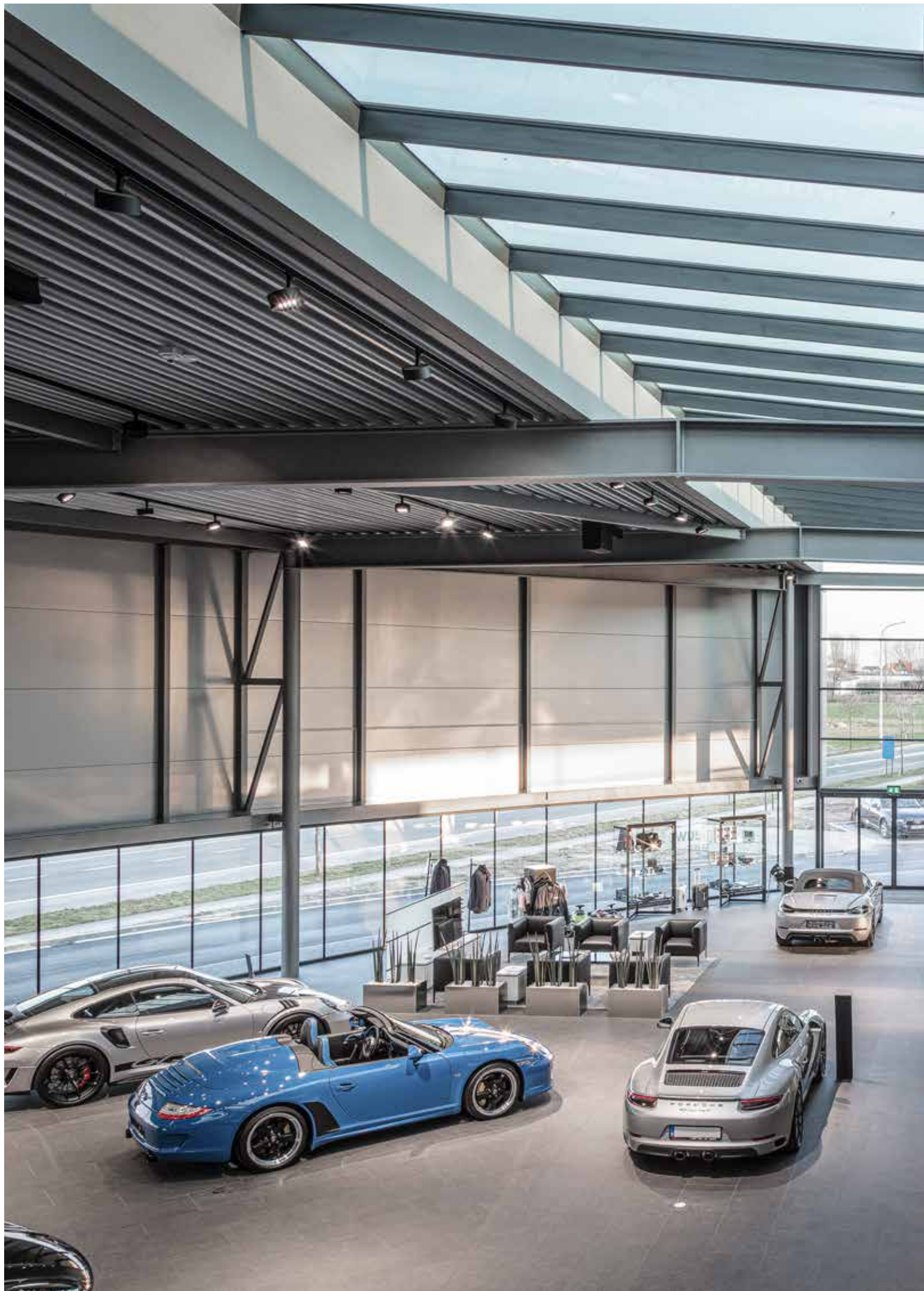





# MULTINOVA

## FAMILY

Multinova has something familiar and something fresh at the same time. As a disc of light, Nova refers to the Supernova range, as both families share similarities in looks and ways of installation. But Multinova has some additional features to make it multi-applicable, hence Multi in the name.

With 2 different diameters, a down and down-up version and a limited height of only 2"-3/4 - 69mm, Multinova is perfect to use in different ways. Its small dimensions fit in any residential or hospitality project, as a track mounted luminaire it suits any retail environment and with a prismatic sheet for reduced glare it even adapts in office settings. Moreover, Multinova can be used on our Magnetic profiles for general lighting.

Multinova comes in our standard black or white and can also be finished in the warmer Gold Colored to enrich its surroundings. To top it off – next to a sandblasted or prismatic optic – one can opt for a smoked sheet at the front for a more decorative touch. When turned on the disc is fully lit, when turned off a deep dark arises, ideal in combination with a Gold Colored Multinova.

[www.deltalight.us/multinova-track](http://www.deltalight.us/multinova-track)  
[www.deltalight.ca/multinova-track](http://www.deltalight.ca/multinova-track)



**STRAIGHTFORWARD OR PLAYFUL**

On track, Multinova comes as a fix luminaire or as a pivoting disc. Like this, a straightforward light setting can easily be turned into a sparkling play between light and design.

**FAMILY OVERVIEW****CHOOSE YOUR FINISH**

Black / Gold Colored / White

**CHOOSE YOUR INSTALLATION**

Fix / Pivot

**CHOOSE YOUR SIZE & POWER**

Ø 11"-13/16 - 300mm  
Down 14,8W – 2150lm

Ø 21"-5/8 - 550mm  
Down 33,2W – 4820lm

**CHOOSE YOUR COLOR TEMPERATURE**

3000K / 3500K / Tunable White

**CHOOSE YOUR OPTICS**

Sandblasted / Prismatic (UGR<19) / Smoke

**CHOOSE YOUR CONTROL**

0-10V Dim / Lutron Eco

**CHOOSE YOUR FAVORITE TRACK**

Recessed  
Surface mounted  
Suspended

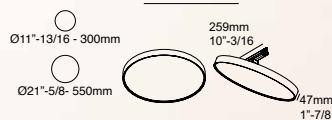





interior  
innovation  
award



reddot design award  
winner

Winner

GOOD  
DESIGN  
award

AWARD  
DESIGN PLUS  
light+building



# SUPERNOVA XS

## FAMILY

With its 10"-1/4 - 26 cm or 13" - 33 cm diameter, Supernova XS is small when it comes to size, but not when it comes to performance and skills. Apart from its design, Supernova has lots of similarities with Super-Oh! XS. Both have a cluster of powerleds embedded behind a sandblasted optic to create a diffused light effect for general lighting and both are able to peek around the room thanks to their clever pivoting installation bracket.

[www.deltalight.us/supernova-xs-track](http://www.deltalight.us/supernova-xs-track)  
[www.deltalight.ca/supernova-xs-track](http://www.deltalight.ca/supernova-xs-track)





**FAMILY OVERVIEW**

**CHOOSE YOUR FINISH**



Black / White

**CHOOSE YOUR SIZE & POWER**

Ø 10"-1/4 - 260mm / 12W - 1050lm  
Ø 15" - 330mm / 22W - 2600lm

**COLOR TEMPERATURE**

3000K

**CHOOSE YOUR CONTROL**

0-10V Dim / Phase Dimming

**CHOOSE YOUR FAVORITE TRACK**

Recessed / Surface mounted / Suspended

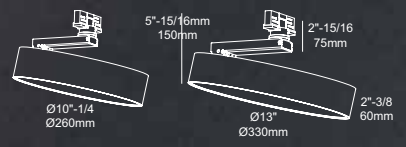





ARCHITECT LHOAS & LHOAS





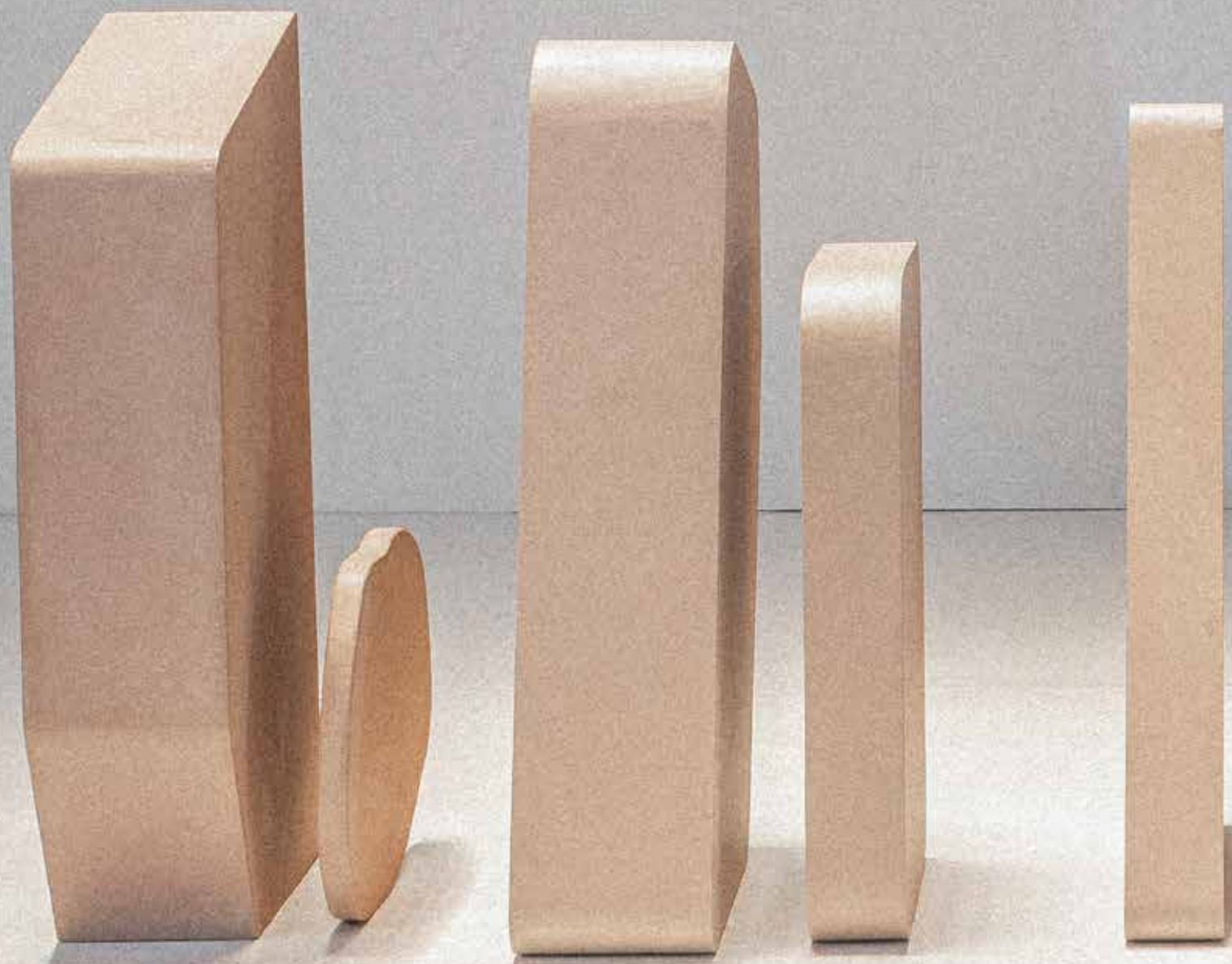





INTERIOR & EXTERIOR

# PROFILES

# MAGNETIC PROFILES

## SPLITLINE M20

P 336

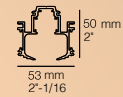

## SPLITLINE M52

P 342

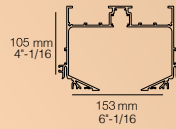

## SHIFTLINE M26L

P 348

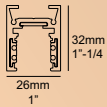

## SHIFTLINE M26H

P 352

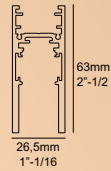

## SHIFTLINE M35R

P 360

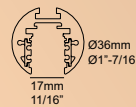

## SHIFTLINE M44

P 364

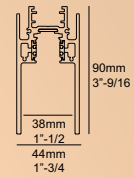



# MODULE PROFILES

NEW

## SHIFTLINE 19

P 366

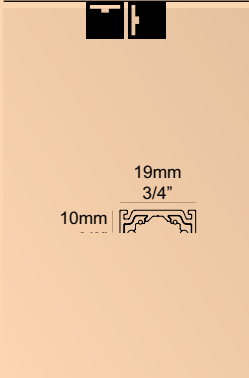

## SPLIT-IT

P 370

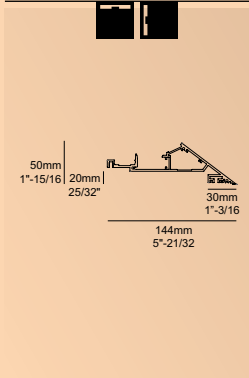

# LED FLEX PROFILES

NEW

## TAGLINE

P 376

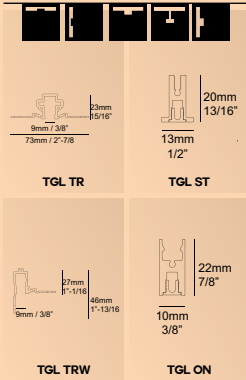

## CONNECT

P 382

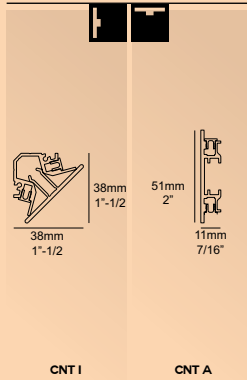

## DOT.COM WW

P 384

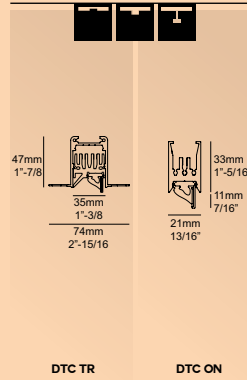

## FEMTOLINE 25

P 388

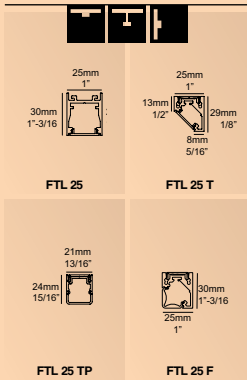

## FEMTOLINE 35

P 396

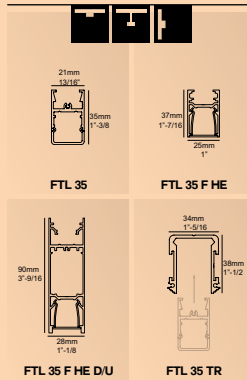

## FEMTOLINE 45

P 400

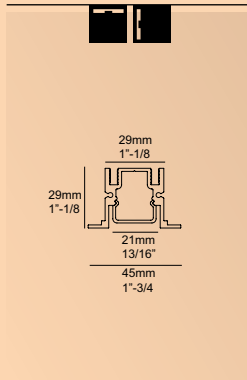

## FEMTOLINE 35 WG

P 394

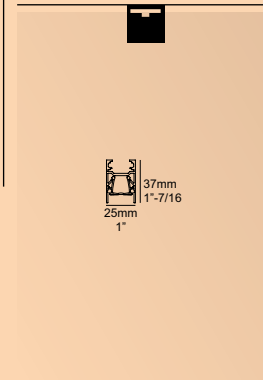

## ONE AND ONLY

P 407

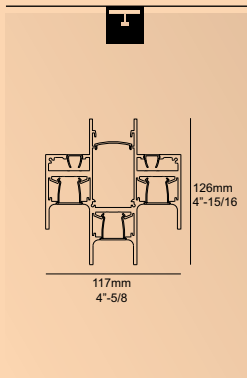

## BORDERLINE

P 412

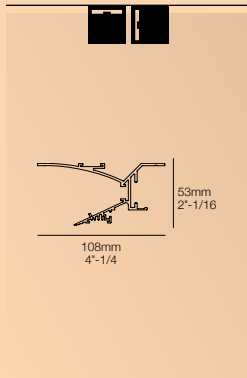

## MICROLINE TR

P 418

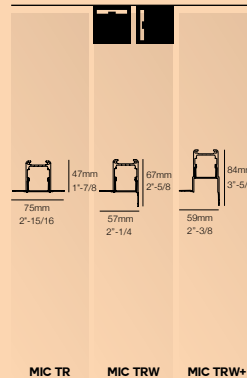

## SHELFLINE

P 436

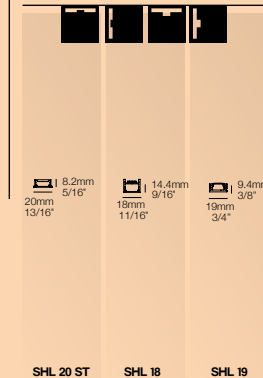

NEW

# LED ARRAY PROFILES

## MICROLINE 40/60

P 418



## STREAMLINER

P 428

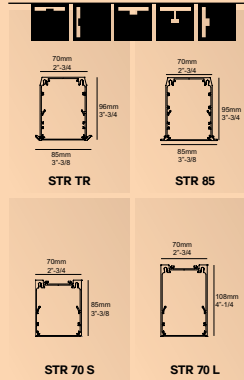



# MAGNETIC

With the magnetic profiles, Delta Light takes it to the next level in the profile section. These profiles offer the highest degree of freedom and flexibility, as all modules have a magnetic fixation. Splitline M20 and M52 allow for a neat, trimless installation, while Shiftline M26, M35 and M44 can be used for projects where surface or suspended mounting is required. To create the optimal light setting, multiple light modules are available: spot modules with different beams and lumen packages going up to 2000lm for accent lighting, linear LED lines for general or wallwash lighting and pendant modules for an elegant finish of the room.

All modules can be placed toolfree into the profile and repositioned afterwards thanks to their magnetic fixation.

Simply click the module into the profile and both mechanical and electrical connection are ensured. As this family of profiles is powered by 48V, Smart 48 can be used for an easy 2-wire dimming/power solution.

For individual control of luminaires, one can opt for a DALI controlled system.

**ACCENT**



SPY 27



ODRON



SPY 39



PION



SPY 52

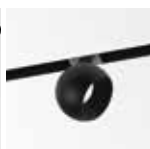

BOWIE



SPY 66



HALOSCAN



SPY FOCUS



TWEETER



VIZIR



HEDRA

**DECORATIVE**



TWEETER BL



GIBBO



MICROSPY C

**GENERAL**



LED LINE HE



LED LINE UP



DOT.COM M



DOT.COM L



LED OK



LED D



MULTINOVA



INFORM

**WALLWASH**



DOT.COM



ARTUUR

# SPLITLINE M20

Splitline M20 combines the refinement and the cleanness of Splitline 16 with a boost of flexibility thanks to the magnetic mounting of the light modules. Together with the mechanical connection, the magnetic fixation of the modules ensures the electrical connection with the two 48V conductors in the profile.

In this way all light modules – spots, linear LED lines and pendants – can easily be placed or replaced into the profile according to the project's requirements, without the need of any tools.

[www.deltalight.us/splitline-m20-profile](http://www.deltalight.us/splitline-m20-profile)

[www.deltalight.ca/splitline-m20-profile](http://www.deltalight.ca/splitline-m20-profile)

## FAMILY OVERVIEW

### COLOR



Black

### CHOOSE YOUR SETTING

Straight lines,  
with 90° corners or bended curves

### CHOOSE YOUR LIGHT MODULES

Accent

Spy / Vizir / Hedra / Punk / Tweeter /  
Pion / Odron / Bowie / Haloscan

Decorative

Tweeter BL / Gibbo / Spy

General

Inform / LED Line / Dot.Com / Multinova

Wallwash

Dot.Com / Artuur

### CHOOSE YOUR CONTROL

Modulator Dim / Wireless Dim / DALI Dim

### CHOOSE YOUR EXTRA'S

Sensors

Presence - Daylight

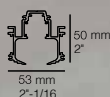





PROJECT INSTORE / PHOTOGRAPHY MICHEL FIGUET









# SPLITLINE M52

One catchphrase could best describe the Splitline M52: Flexibility at its best! Apart from protruding spots and pendant modules, this wider profile also allows for adjustable spot modules to be hidden inside the black line in the ceiling, resulting in a serene setting of the room. Similar to Splitline M20, all modules can be toolfree installed and repositioned into the profile thanks to their magnetic fixation, allowing the end user to adapt the light according to the setting of the room.

[www.deltalight.us/splitline-m52-profile](http://www.deltalight.us/splitline-m52-profile)  
[www.deltalight.ca/splitline-m52-profile](http://www.deltalight.ca/splitline-m52-profile)

## FAMILY OVERVIEW

### COLOR



Black

### CHOOSE YOUR SETTING

Straight lines or with 90° corners

### CHOOSE YOUR LIGHT MODULES

Accent

1 LED / 2 LED / Spy

Decorative

Gibbo / Spy

### CHOOSE YOUR CONTROL

Modulator Dim / Wireless Dim / DALI Dim

### CHOOSE YOUR EXTRA'S

Sensors

Presence - Daylight

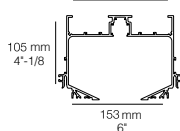





INTERIOR DESIGN MANUEL GARCÍA ASOCIADOS



STUDIO DIDEA









# SHIFTLINE M26L / MATRIX

Shiftline M26 L is the surface mounted variant of Splitline M20, ideal when recessed mounting is not an option.

Spy, Vizir and Hedra modules - in different sizes and lumen packages - can be combined with Tweeter modules, linear LED lighting or pendant modules as Microspy 39 C or Gibbo, giving you loads of possibilities to create your own ideal lighting scene. Do not worry if you overlooked something in this ideal lighting scene, as all modules can be easily switched from position thanks to their magnetic fixation.

[www.deltalight.us/shiftline-m26-l-profile](http://www.deltalight.us/shiftline-m26-l-profile)  
[www.deltalight.ca/shiftline-m26-l-profile](http://www.deltalight.ca/shiftline-m26-l-profile)

[www.deltalight.us/shiftline-m26-l-matrix](http://www.deltalight.us/shiftline-m26-l-matrix)  
[www.deltalight.ca/shiftline-m26-l-matrix](http://www.deltalight.ca/shiftline-m26-l-matrix)

## FAMILY OVERVIEW

### CHOOSE YOUR FINISH



Black / Brushed Bronze / Polished Alu / White

### CHOOSE YOUR SETTING

Straight lines or with 90° corners

Create a Matrix structure  
with several layers of light  
in any desired direction.

### CHOOSE YOUR INSTALLATION

Surface mounted / Suspended

### CHOOSE YOUR LIGHT MODULES

Accent

Spy / Vizir / Hedra / Tweeter / Pion / Odron / Bowie /  
Haloscan

Decorative

Tweeter BL / Gibbo / Spy

General

Inform / LED Line / Dot.Com / Multinova

### CHOOSE YOUR CONTROL

Modulator Dim / Wireless Dim / DALI Dim

### CHOOSE YOUR EXTRA'S

Sensors

Presence - Daylight

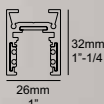

**MATRIX** PATENTED

Unlimited flexibility is what the Shiftline M26 L Matrix system stands for. These clever add-ons to the Shiftline M26 L profiles allow you to couple multiple profiles to each other and create any structure you want. Our 2P Connector not only assures the electrical connection between two profiles, it also serves as a decorative element as its cylindrical shape is perfectly in contrast with the straight lines of the profile. Moreover, this contrast can be enhanced by choosing the Gold Colored finish for these nodes, a bold statement where design meets functionality.

To complete the Matrix system, an additional ceiling fixation and a non electrical connector allow for unlimited creativity as one is free to connect multiple profiles any way they want. Moreover, the new Side Supply finishes it off in style as it is designed according to the looks of the 2P Connector.





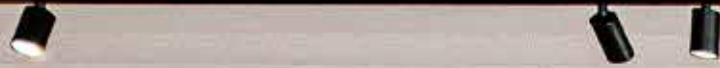

# SHIFTLINE M26H

The higher version of our Shiftline M26 creates extra possibilities in terms of functionality, as the profile allows to combine modules for direct lighting with linear modules for indirect lighting, a perfect way to enhance the spacial feeling of the room.

To break the linearity of the Shiftline M26 H, 2 curved corners are available to go from a straight lighting pattern to a free-form lighting set-up. The bends of 90° and 135° allow you to create the set-up of your desires.

[www.deltalight.us/shiftline-m26-h-profile](http://www.deltalight.us/shiftline-m26-h-profile)  
[www.deltalight.ca/shiftline-m26-h-profile](http://www.deltalight.ca/shiftline-m26-h-profile)

**FAMILY OVERVIEW**

**CHOOSE YOUR FINISH**



Black / Brushed Bronze / Polished Alu / White

**CHOOSE YOUR SETTING**

Straight lines, with corners or bended curves

**CHOOSE YOUR INSTALLATION**

Surface mounted / Suspended

**CHOOSE YOUR LIGHT MODULES**

Accent

Spy / Vizir / Hedra / Tweeter / Pion / Odron / Bowie / Haloscan

Decorative

Tweeter BL / Gibbo / Spy

General

Inform / LED Line / LED Line Up / Dot.Com / Multinova

**CHOOSE YOUR CONTROL**

Modulator Dim / Wireless Dim / DALI Dim

**CHOOSE YOUR EXTRA'S**

Sensors

Presence - Daylight

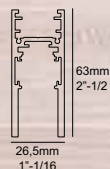







ARCHITECTENBUREAU WOUTER NAERT / INTERIOR DESIGN CHARLOTTE VAN BRUWAENE





INTERIOR DESIGN MAILSTER

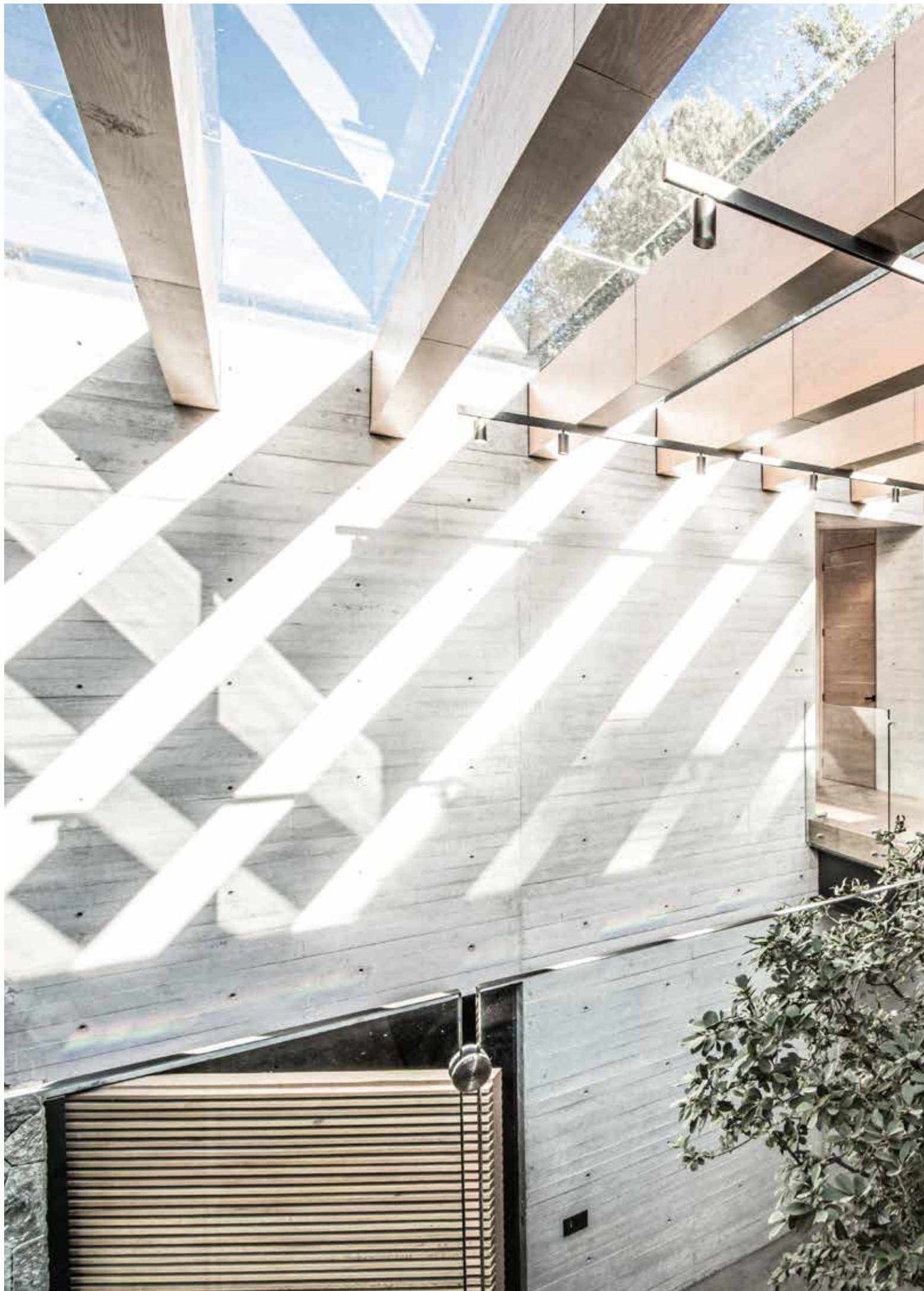

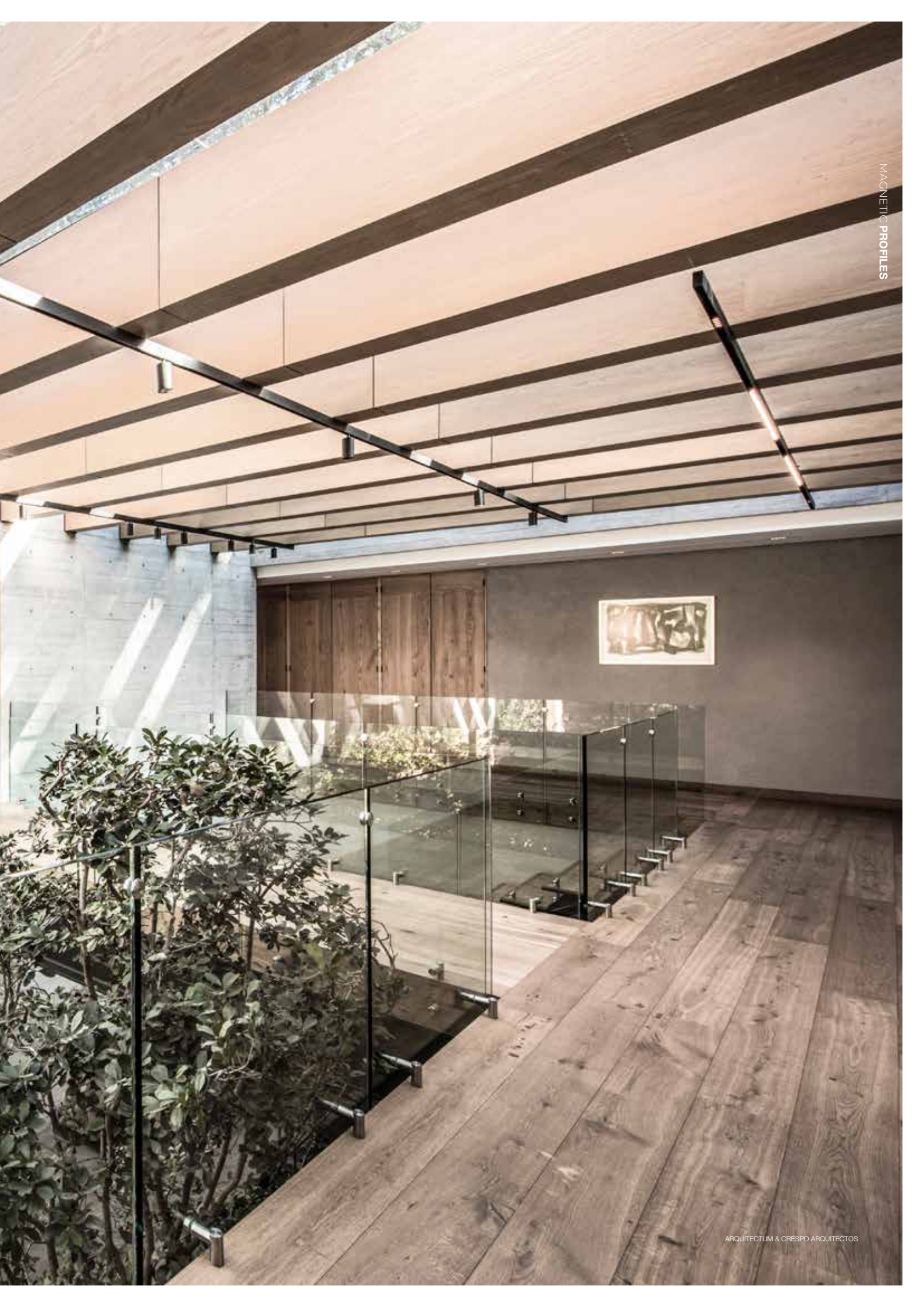



# SHIFTLINE M35R

With its cylindrical shape, Shiftline M35R is a decorative element on its own. Combined with the suspended Microspy 39 C or Gibbo it can easily upscale any project. By adding magnetic spot modules or linear lighting, Shiftline M35R gives a sophisticated touch to functional lighting.

[www.deltalight.us/shiftline-m35-r-profile](http://www.deltalight.us/shiftline-m35-r-profile)  
[www.deltalight.ca/shiftline-m35-r-profile](http://www.deltalight.ca/shiftline-m35-r-profile)



## FAMILY OVERVIEW

### CHOOSE YOUR FINISH



Black / White

### CHOOSE YOUR SETTING

Straight lines, with corners or bended curves

### CHOOSE YOUR INSTALLATION

Surface mounted / Suspended

### CHOOSE YOUR LIGHT MODULES

Accent

Spy / Vizir / Hedra / Tweeter / Pion / Odrón / Bowie / Haloscan

Decorative

Tweeter BL / Gibbo / Spy

General

Inform / LED Line / Dot.Corn / Multinova

### CHOOSE YOUR CONTROL

Modulator Dim / Wireless Dim / DALI Dim

### CHOOSE YOUR EXTRA'S

Sensors

Presence - Daylight

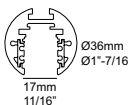





INTERIOR DESIGN INHABIT / LIGHTING DESIGN BIG ARCHITECTURAL LIGHTING / PHOTOGRAPHY ELIN RODESTRAND @ELINRPHOTOGRAPHY







# SHIFTLINE M44

The broader Shiftline M44 is a surface or suspended magnetic profile that combines different types of lighting without the light modules being visible outside the profile. Linear modules or individual downlights for general lighting and Dot.Com for office lighting can easily be combined with uplight to enhance the volume of the room.

[www.deltalight.us/shiftline-m44-profile](http://www.deltalight.us/shiftline-m44-profile)  
[www.deltalight.ca/shiftline-m44-profile](http://www.deltalight.ca/shiftline-m44-profile)

## FAMILY OVERVIEW

### CHOOSE YOUR FINISH



Black / White

### CHOOSE YOUR SETTING

Straight lines or with 90° corners

### CHOOSE YOUR INSTALLATION

Surface mounted / Suspended

### CHOOSE YOUR LIGHT MODULES

Accent

1 LED / 2 LED

Decorative

Gibbo / Spy

General

Inform / LED Line / LED Line Up / Dot.Com

### CHOOSE YOUR CONTROL

Modulator Dim / Wireless Dim / DALI Dim

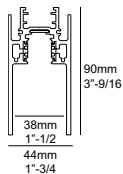



# SHIFTLINE 19

This miniature profile lets you combine accent lighting and decorative lighting in the shape of Spy 27 and Spy 39.

Containing 2 48V and 2 Dim conductors for individual DALI Dimming, the slender profile can easily be combined with Smart 48 and CTRL Delta to offer a quick and easy, minimalistic, wireless lighting set-up.

Shiftline 19 has many application possibilities, as its dimensions are reduced to a minimum which allow a surface mounted installation that only requires a minimum of space. Be it in residential, hospitality or in retail, the different modules to apply on the Shiftline 19 track can be used for accent lighting or decorative lighting, offering multiple ways of flexibility.

[www.deltalight.us/shiftline-19-profile](http://www.deltalight.us/shiftline-19-profile)  
[www.deltalight.ca/shiftline-19-profile](http://www.deltalight.ca/shiftline-19-profile)

## FAMILY OVERVIEW

### CHOOSE YOUR FINISH



Black / White

### CHOOSE YOUR SETTING

Any desired length

Go around the corner

Go from horizontal to vertical

### CHOOSE YOUR LIGHT MODULES

Spy 27 / Spy 39

### CHOOSE YOUR CONTROL

MDL Dim (Smart 48) / DALI Dim

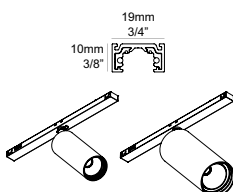









# SPLIT-IT

The Split-it made-to-measure lighting system integrates seamlessly with architecture and demonstrates that form and functionality of lighting have definitely gone down a new path, opening new ways to integrate "lighting paths" with architecture.

The Split-it Pro is a single profile which can be used on its own, or in combination of two. When used as a single profile the Split-it concept can be used parallel with the wall. In a double set-up the Split-It Pro enables you to create a linear setting with Dimensions of your choice. The Pro version enables integration of edgeless lighting paths, either vertically or horizontally. Its 37° degree sharp edge gives walls and ceilings a 'paper-thin' appearance, with no visible wires and no shadow gaps, upgrading the level of architectural detail. It offers not only new ways to give shape to any lighting need, it also gives the possibility to integrate other engineering and technological necessities.

With its linear geometry the Split-it Pro enables you to define spaces and create volumes, to show direction, frame the room and add sharp edged detail to your architecture. It can be combined with a multitude of spots available for specific and demanding lighting needs, ranging up to 2000lm and offering multiple beam optics. All tools are available to meet the specific needs of your project.

[www.deltalight.us/split-it-profile](http://www.deltalight.us/split-it-profile)  
[www.deltalight.ca/split-it-profile](http://www.deltalight.ca/split-it-profile)

## FAMILY OVERVIEW

### CHOOSE YOUR FINISH



Black / White

### CHOOSE YOUR SETTING

Straight lines or with corners

### CHOOSE YOUR LIGHT EFFECT

Indirect light

5W up to 21W per meter

Accent light  
with Spy modules

### CHOOSE YOUR COLOR TEMPERATURE

2700K / 3000K / 3500K / 4000K

Soft Dim / RGB / RGB TW - Tunable White

### CHOOSE YOUR CONTROL

Non Dim / 0-10V Dim / Dali Dim

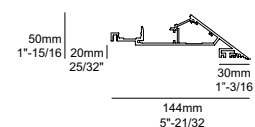









INTERIOR DESIGN VUAD - VIKTOR UDZENIJA / PHOTOGRAPHY LUCA CIOCI





# TAGLINE

The Tagline made-to-measure profile provides an ultra-minimalistic light line that integrates seamlessly with the architectural lines of your project. Limited to only 1/4" - 7mm the Tagline seems almost invisible, a slender line of light that cuts through space.

Available in different application versions - from trimless recessed to surface mounted, as a pendant solution or as perimeter lighting - Tagline is offered as a creative tool for architects and designers to accentuate architectural detail or characterise environments. Any space becomes distinctively elegant when the Tagline is used in a simple linear way, or can become very magical and unique when used in a composition.

## TAGLINE TR / TRW

The ultra-minimalistic solution within the Tagline range, as these profiles are seamlessly installed into the ceiling, without any visible trim. Tagline TRW is ideal to contour the perimeter of the room, as it integrates perfect in between corners where ceiling and wall interact.

## TAGLINE ST / ON

Tagline ST and Tagline On have a little bit more body to it, as these will always have a visible trim, offering continuous lines of light for general lighting, be it recessed, surface mounted or suspended.

[www.deltalight.us/tagline-profile](http://www.deltalight.us/tagline-profile)  
[www.deltalight.ca/tagline-profile](http://www.deltalight.ca/tagline-profile)

### FAMILY OVERVIEW

#### CHOOSE YOUR FINISH



Black / Gold Colored / White

#### CHOOSE YOUR INSTALLATION

Recessed  
with trim / trimless  
Surface mounted  
Suspended

#### POWER

820 lm/m

#### CHOOSE YOUR COLOR TEMPERATURE

2700K / 3000K / 3500K / 4000K

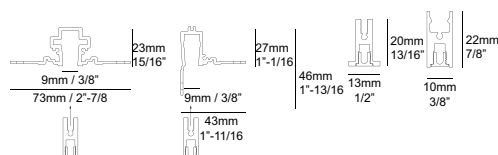





STUDIO DIDEA









# CONNECT

## CONNECT I

Connect I balances on the edge between wall and ceiling or wall and wall, as you like. Mounted directly into the corner, this minimalistic profile generates a soft line of light on one or both sides, transforming bare corners into decorative perimeters.

## CONNECT A

The delicate Connect A is designed to add subtle accents onto vertical surfaces. Emitted from a profile of only 7/16" - 11mm by 2" - 51mm, Connect A can be applied as a linear down-up light.

[www.deltalight.us/connect-profile](http://www.deltalight.us/connect-profile)

[www.deltalight.ca/connect-profile](http://www.deltalight.ca/connect-profile)

## FAMILY OVERVIEW

### CHOOSE YOUR FINISH



Black / White

### CHOOSE YOUR INSTALLATION

Surface mounted  
ceiling / wall

### POWER

820 lm/m

### CHOOSE YOUR COLOR TEMPERATURE

2700K / 3000K / 3500K / 4000K

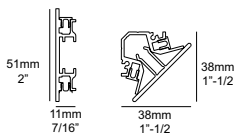



# DOT.COM WALLWASH

Our Dot.Com family is not only limited to spotlight beam angles, it also has linear wallwashers in its range for a soft, even light effect on vertical surfaces. These come as single luminaires, as modules to fit in the magnetic profiles and as a bespoke trimless or surface mounted profile solution, perfect to adapt the light to your specific desires.

[www.deltalight.us/dot-com-profile](http://www.deltalight.us/dot-com-profile)

[www.deltalight.ca/dot-com-profile](http://www.deltalight.ca/dot-com-profile)

## FAMILY OVERVIEW

### CHOOSE YOUR FINISH



Black / White

### CHOOSE YOUR INSTALLATION

Recessed - Trimless /  
Surface mounted / Suspended

### CHOOSE YOUR SETTING

Straight lines or with 90° corners

### CHOOSE YOUR POWER

5W up to 20W/m – 550 up to 2470lm/m

### CHOOSE YOUR COLOR TEMPERATURE

2700K / 3000K / 3500K / 4000K

Soft Dim / RGB / RGB TW - Tunable White

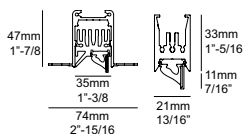

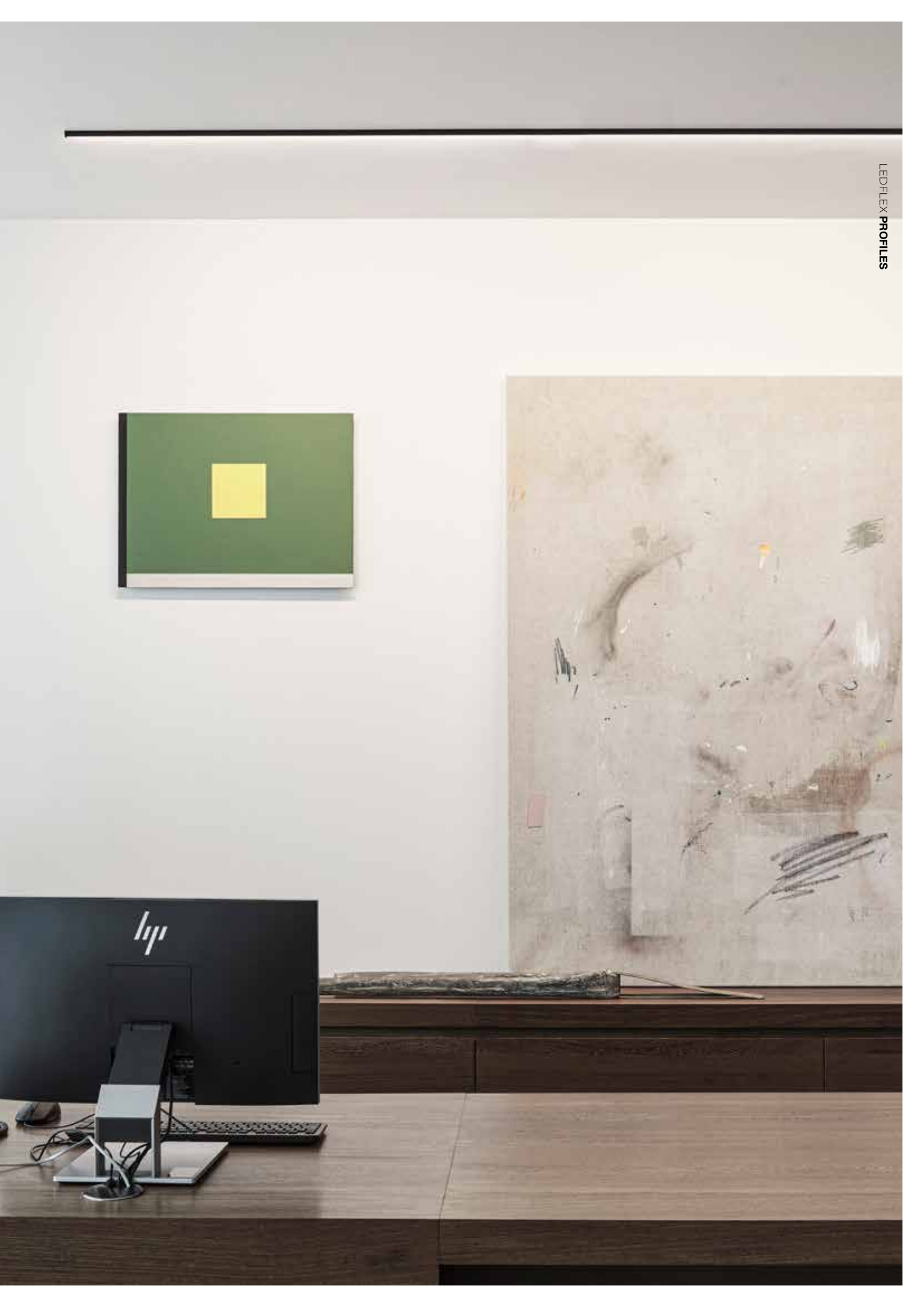

# FEMTOLINE

## FAMILY

The range of Femtoline profiles is very extensive, with each family member having its own specific design and application area. Small or wider profile design, down or down-up lighting, wall, ceiling or floor mounted, flush or tilted plexi ... the Femtoline family offers a solution to any lighting problem.

**[www.deltalight.us/femtoline-profile](http://www.deltalight.us/femtoline-profile)**  
**[www.deltalight.ca/femtoline-profile](http://www.deltalight.ca/femtoline-profile)**





# FEMTOLINE 25

The smallest of the range for surface mounted lighting solutions. Femtoline 25 offers 3 ways of general lighting: standard with a semi-recessed plexi that creates both direct and indirect lighting, Femtoline 25 F with a flush plexi for direct lighting and Femtoline 25 T with a tilted plexi to create an asymmetric light effect.

[www.deltalight.us/femtoline-profile](http://www.deltalight.us/femtoline-profile)  
[www.deltalight.ca/femtoline-profile](http://www.deltalight.ca/femtoline-profile)

## FAMILY OVERVIEW

### CHOOSE YOUR FINISH



Anodized / Black / White

### CHOOSE YOUR VERSION

25 & 25F – General downlight  
 25T & 25TP – Asymmetric light

### CHOOSE YOUR SETTING

Straight lines or with 90° corners

### CHOOSE YOUR LOCATION

Interior / Exterior

### CHOOSE YOUR POWER

5W up to 20W/m – 550 up to 2470lm/m

### CHOOSE YOUR COLOR TEMPERATURE

2700K / 3000K / 3500K / 4000K  
 Soft Dim / RGB / RGB TW - Tunable White

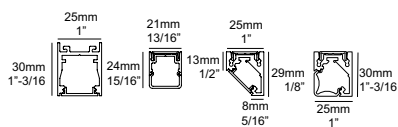









STUDIO2 ARCHITECTS / PHOTOGRAPHY SIMON DEVITT



INTERIOR DESIGN OMAR ABDELGHAFOUR - LIGHT SPACE DESIGN / CONCEPT BLACK FOR GREEN SCAPE



A play of light and shadow

# FEMTOLINE 35 WALLGRAZER





The in-house developed lens extrusion is designed to fulfill multiple functionalities to create the optimal grazing effect. First of all, its specific shape generates a double light effect: in one direction it produces a small light beam to graze along the surface, even for higher walls, in the other direction the purpose is to widen the beam to obtain the same effect as wide as possible. Its second task is to do all of this without losing sight of the visual perception. Thanks to a special treatment of the lens, the LED dots of the LEDflex are being transformed into a uniform line of light without any obtrusive effect to the eye.

[www.deltalight.us/femtoline-profile](http://www.deltalight.us/femtoline-profile)  
[www.deltalight.ca/femtoline-profile](http://www.deltalight.ca/femtoline-profile)

#### FAMILY OVERVIEW

#### CHOOSE YOUR FINISH



Anodized / Black / White

#### CHOOSE YOUR POWER

5W up to 20W/m – 550 up to 2470lm/m

#### CHOOSE YOUR COLOR TEMPERATURE

2700K / 3000K / 3500K / 4000K

#### CHOOSE YOUR ACCESSORY

Add a tilting set for a perfect alignment of the beam



# FEMTOLINE 35

The most versatile of the range. Similar as with Femtoline 25, one can opt for direct lighting with Femtoline 35 or a more indirect general lighting with Femtoline 35 F. Furthermore, Femtoline 35 can be used within the trimless Femtoline 35 TR profile, creating a black cove filled with strokes of light. As a pendant for down or down-up lighting, one can opt for the straightforward Femtoline 35 F HE D-U with its H-shaped design that hides away the plexi from below.

[www.deltalight.us/femtoline-profile](http://www.deltalight.us/femtoline-profile)  
[www.deltalight.ca/femtoline-profile](http://www.deltalight.ca/femtoline-profile)

## FAMILY OVERVIEW

### CHOOSE YOUR FINISH



Anodized / Black / White

### CHOOSE YOUR INSTALLATION

Recessed - Trimless /  
Surface mounted / Suspended

### CHOOSE YOUR VERSION

35TR / 35 / 35F HE – General downlight  
35F HE D-U – General down- & uplight

### CHOOSE YOUR SETTING

Straight lines or with 90° corners

### CHOOSE YOUR LOCATION

Interior / Exterior

### CHOOSE YOUR POWER

5W up to 20W/m – 550 up to 2470lm/m

### CHOOSE YOUR COLOR TEMPERATURE

2700K / 3000K / 3500K / 4000K  
Soft Dim / RGB / RGB TW - Tunable White

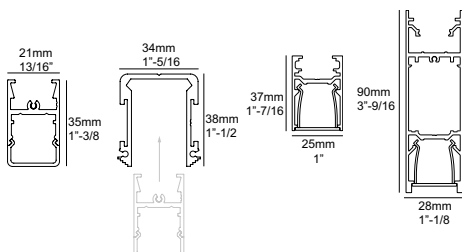

ARCHITECT TETRIS





ARCHITECT ATELIER SILHOUETTE URBAINE



# FEMTOLINE 45

The recessed solution. Femtoline 45 complements the Femtoline 25 range in applications that allow recessed installation.

[www.deltalight.us/femtoline-profile](http://www.deltalight.us/femtoline-profile)  
[www.deltalight.ca/femtoline-profile](http://www.deltalight.ca/femtoline-profile)

## FAMILY OVERVIEW

### CHOOSE YOUR FINISH



Anodized / Black / White

### CHOOSE YOUR SETTING

Straight lines or with 90° corners

### CHOOSE YOUR LOCATION

Interior / Exterior

### CHOOSE YOUR POWER

5W up to 20W/m – 550 up to 2470lm/m

### CHOOSE YOUR COLOR TEMPERATURE

2700K / 3000K / 3500K / 4000K

Soft Dim / RGB / RGB TW - Tunable White

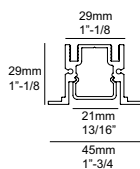







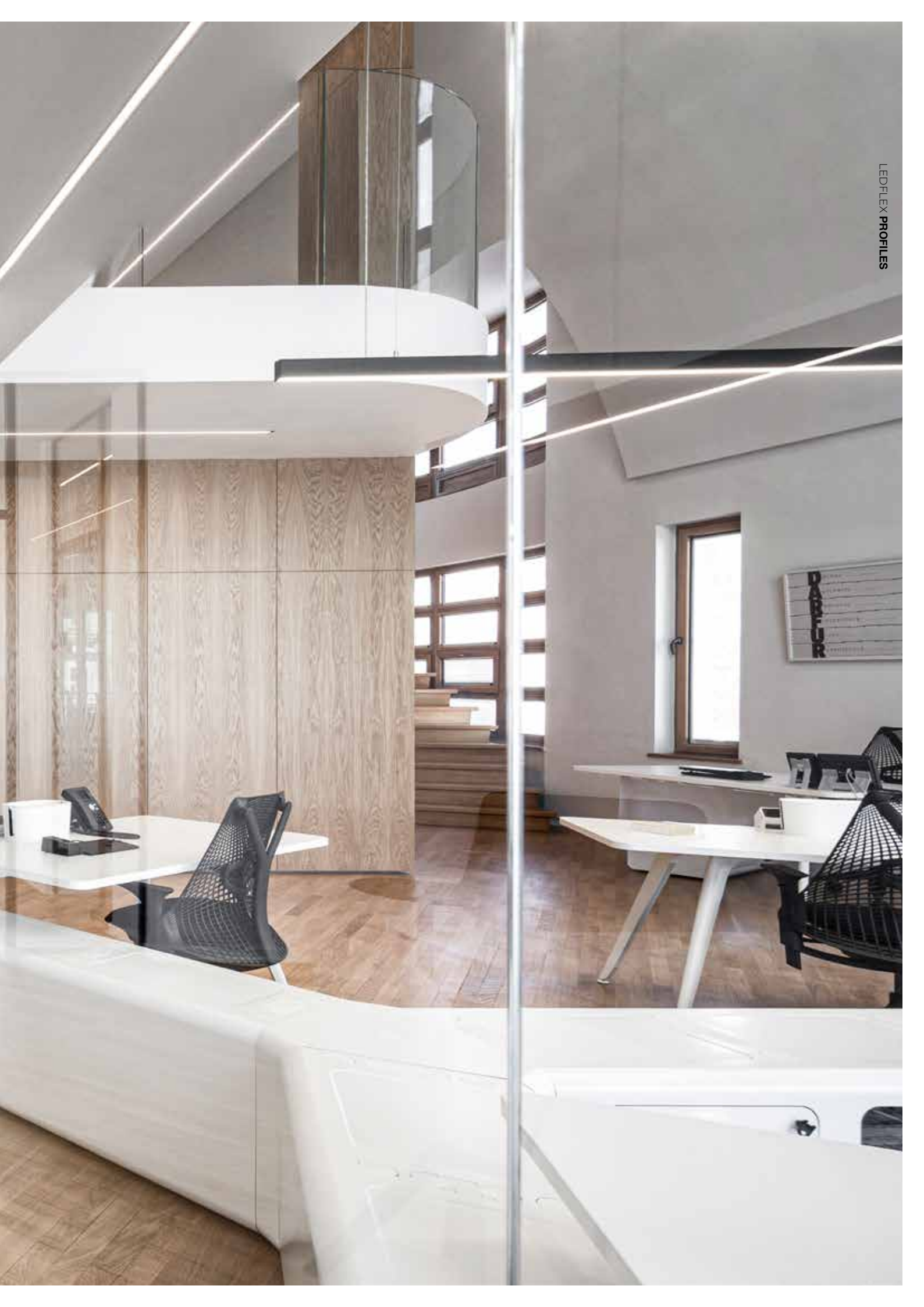

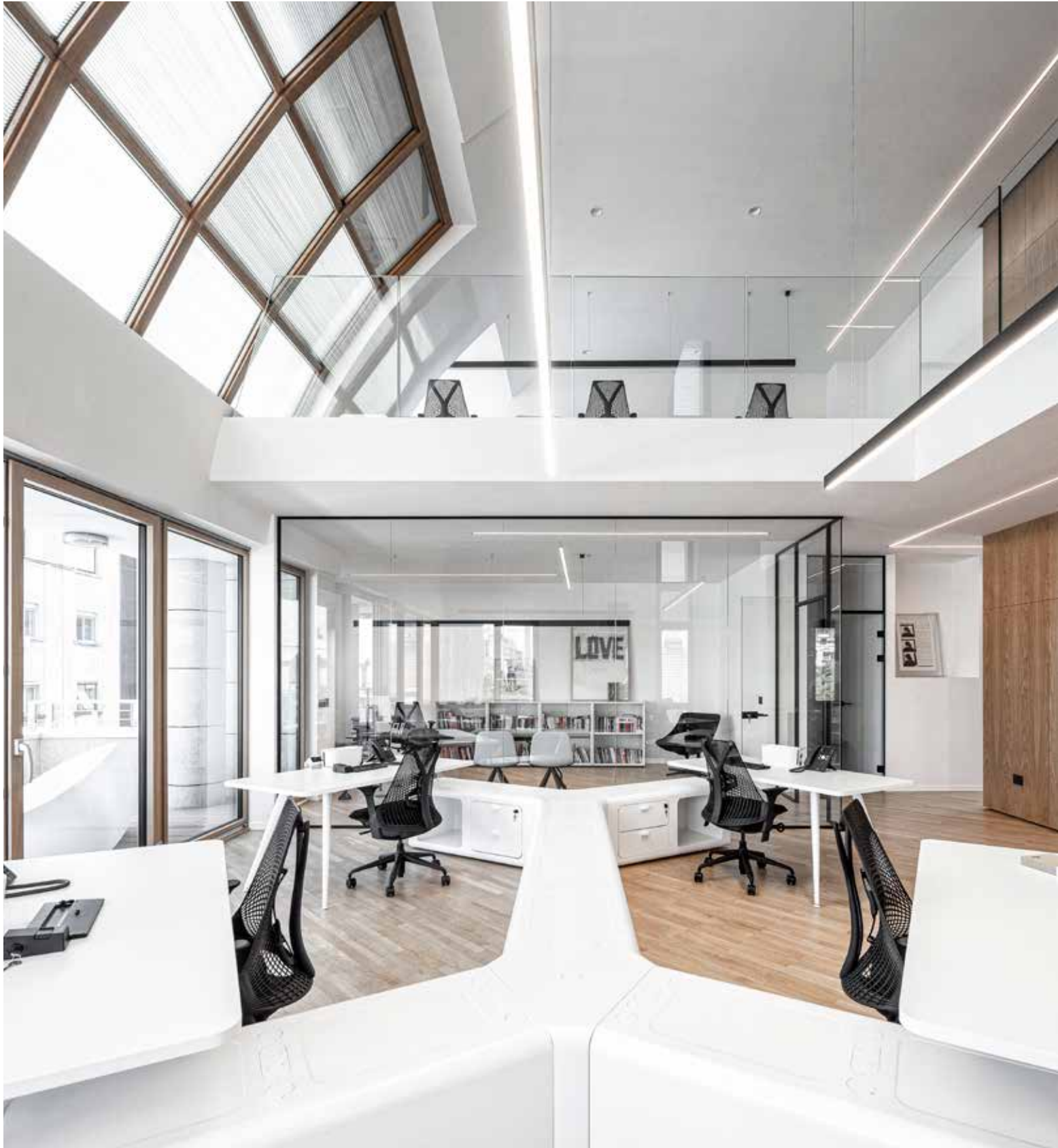

ARCHITECT MILENA VUKMIROVIĆ DARCH





# ONE AND ONLY

A peculiar profile, both functional as decorative. The design of the body allows you to have up to 5 lines of light out of 1 profile, 3 for direct and 2 for indirect lighting. The soft glow of the light along the sides of the profile makes the One-And-Only float through the air, a powerful blend of light for an eye-catching look.

[www.deltalight.us/one-and-only-profile](http://www.deltalight.us/one-and-only-profile)  
[www.deltalight.ca/one-and-only-profile](http://www.deltalight.ca/one-and-only-profile)

## FAMILY OVERVIEW

### CHOOSE YOUR FINISH



Black / Gold Colored / White

### POWER

Down

3 x 1045lm/m

Up

2 x 1045lm/m

### CHOOSE YOUR COLOR TEMPERATURE

2700K / 3000K / 3500K / 4000K

### CHOOSE YOUR CONTROL

Phase Dimming / 0-10V Dim

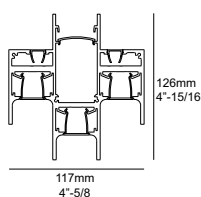



INTERIOR ARCHITECTURE BY @AFC-COLLECTION



I-COR (INTERIOR CONCEPT STORE ROESELARE) WWW.I-COR.BE







BNP ARCHITECTEN / INTERIOR DESIGN CRENEAU INTERNATIONAL

# BORDERLINE

With the Borderline profile Delta Light introduces a generation of recessed led profiles, setting standards in the indirect lighting segment. It features a remarkable trimless finishing, although easy to install and finish.

The Borderline can be used for both wall and ceiling application, enabling you to frame the room with light. Available with RGB, tunable white, warm or cold white LEDs, offering a contemporary indirect lighting solution with exceptional eye for architectural detail.

[www.deltalight.us/borderline-profile](http://www.deltalight.us/borderline-profile)  
[www.deltalight.ca/borderline-profile](http://www.deltalight.ca/borderline-profile)

## FAMILY OVERVIEW

### COLOR



White

### CHOOSE YOUR SETTING

Straight lines or with 90° corners

### CHOOSE YOUR POWER

5W up to 20W/m – 550 up to 2470lm/m

### CHOOSE YOUR COLOR TEMPERATURE

2700K / 3000K / 3500K / 4000K

Soft Dim / RGB / RGB TW - Tunable White

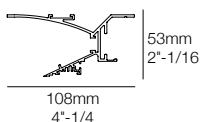





NINA MAYA INTERIORS - PHOTOGRAPHY NICOLE ENGLAND







ARCHITECT NIKOLAS DEBRAUWER

# MICROLINE

A series of slim, made-to-measure LED profiles which stand out for their versatility and clean-cut design. The Microline profiles are designed to create uninterrupted lines of light, ideal to accentuate architectural lines or be used as general lighting.

## MICROLINE TR

The Microline Trimless profiles are the perfect solution for cove lighting. The ability to create lines, internal and external corners allows the designer to draw all perimeters of the room, even those with the most expressive geometrics. An invisible light effect, all without interruption.

## MICROLINE 40/60

The Microline 40/60 profile was created as a high efficiency replacement for the original 30/50 profile. The high-output led array is available with a dimmable power supply with 151lm/W and as a non-dimmable version delivering 167lm/W. In addition, the 40+ features a protruding polycarbonate for extra wide light output.

[www.deltalight.us/microline-profile](http://www.deltalight.us/microline-profile)  
[www.deltalight.ca/microline-profile](http://www.deltalight.ca/microline-profile)

### MICROLINE TR

#### CHOOSE YOUR FINISH



Anodized

#### CHOOSE YOUR SETTING

Straight lines or with 90° corners

#### CHOOSE YOUR POWER

5W up to 20W/m – 550 up to 2470lm/m

#### CHOOSE YOUR COLOR TEMPERATURE

2700K / 3000K / 3500K / 4000K

Soft Dim / RGB / RGB TW - Tunable White

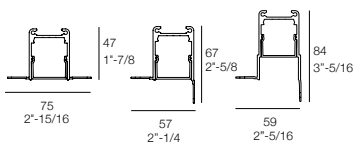

### MICROLINE 40/60

#### CHOOSE YOUR FINISH



Anodized / Black / White

#### CHOOSE YOUR INSTALLATION

Recessed / Surface mounted / Suspended

#### CHOOSE YOUR SETTING

Straight lines or with 90° corners

#### CHOOSE YOUR POWER

1900 lm/m / 3600 lm/m

#### CHOOSE YOUR COLOR TEMPERATURE

3000K / 3500K

#### CHOOSE YOUR CONTROL

0-10V Dim / Lutron ECO

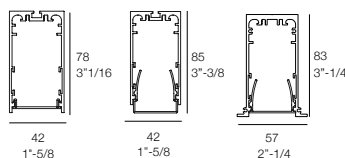







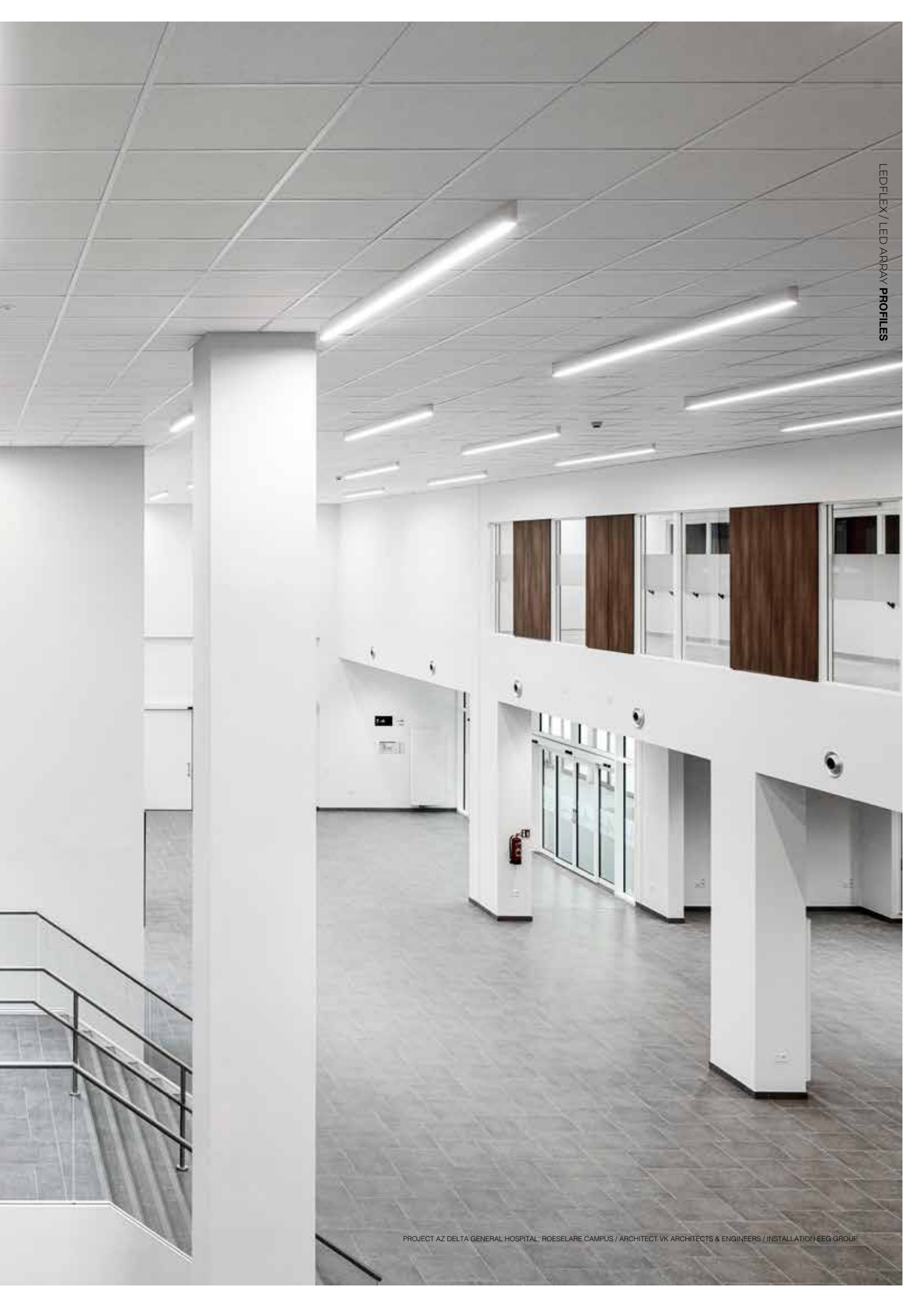



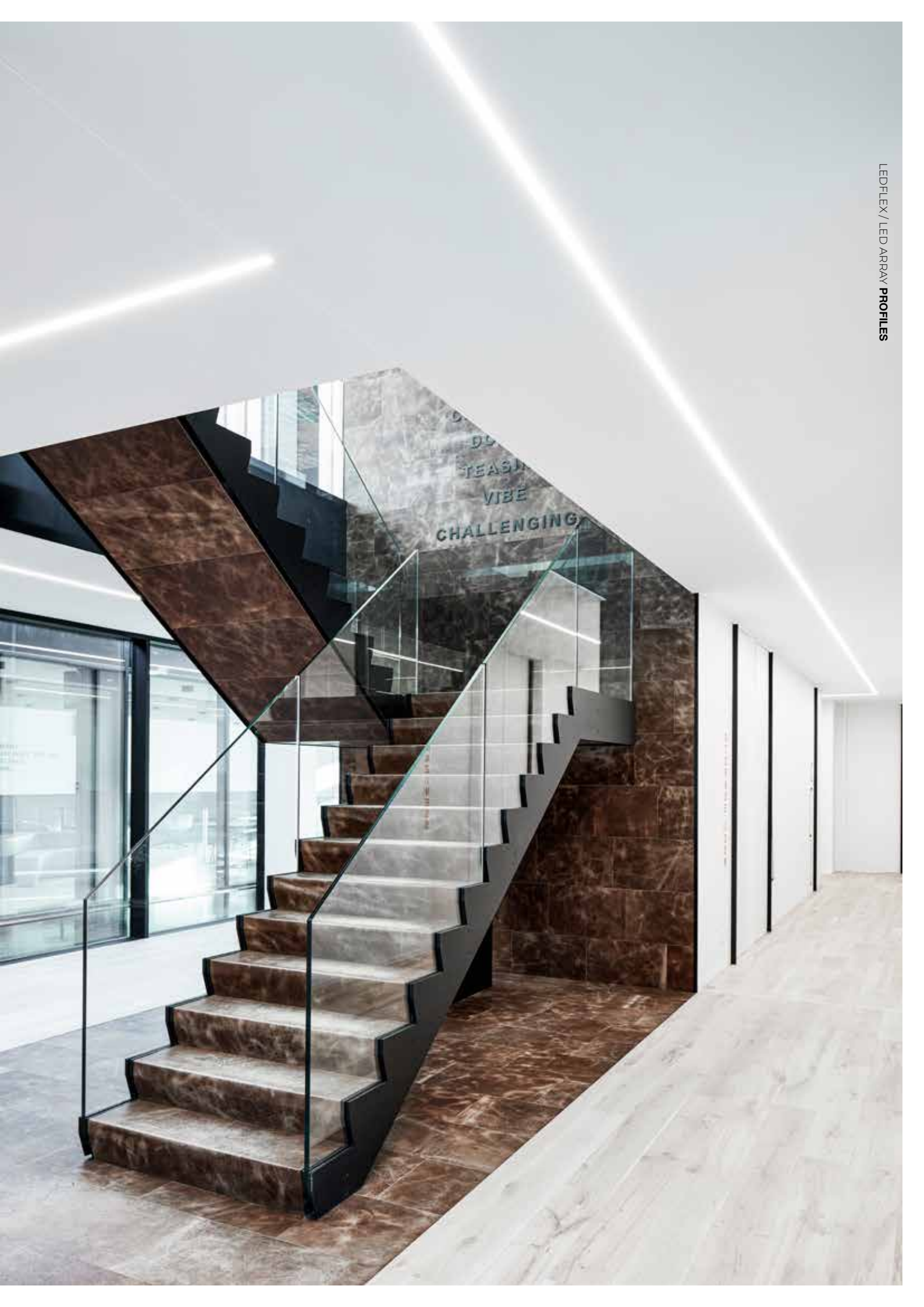











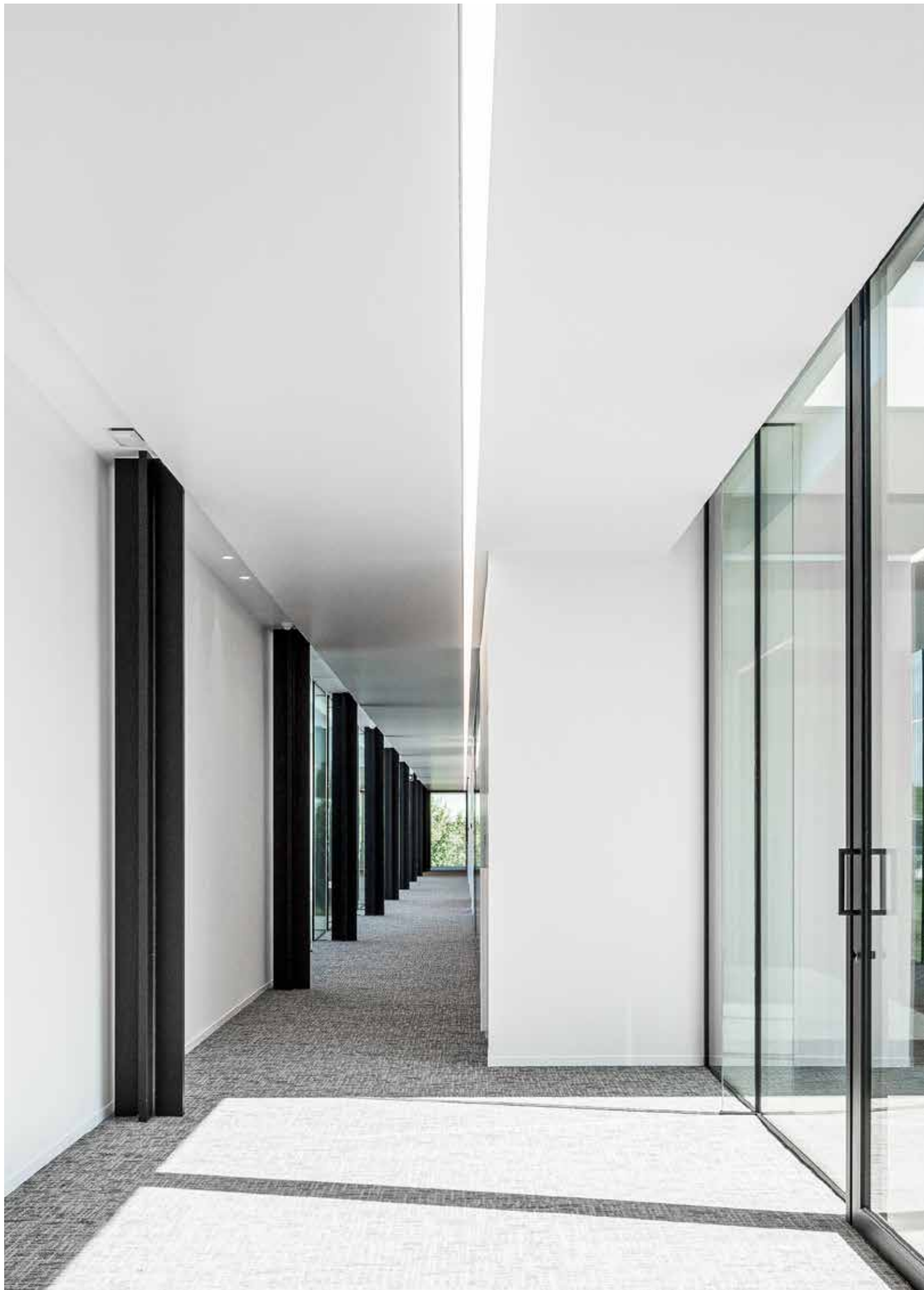

The made-to-measure Streamliner is a very versatile LED-focused profile family. Its multiple installation options combined with the possibility to add spots and downlights, allow Streamliner to be used in various applications. Inside, the LED array is available in 2 different output levels and can be finished with an opal or prismatic cover. The possibility to use Tunable White further adds to the flexibility of Streamliner

Streamliner can be recessed mounted, with (Streamliner 85) or without trim (Streamliner TR), surface or pendant mounted. As a pendant version, the profile can be used with only direct light or there is also the opportunity to have it direct-indirect. To give the profile even more flexibility, also integrated downlighters and additional spots are available.

#### STREAMLINER TR / STREAMLINER 85

Streamliner TR and Streamliner 85 are the recessed solutions within the Streamliner range. Streamliner TR can be finished without any visible trim, while Streamliner 85 has a small trim covering the hole in the ceiling. In both cases a homogenous line of light is all you see, as the profile completely disappears into the ceiling.

Fully lit corners allow you to play around with lines of light, creating unique patterns that strengthen the architecture of the building.

#### STREAMLINER 70S / 70L

Streamliner 70S and 70L can be used for surface mounted or suspended applications, both offering the possibility to be used as a direct-indirect or purely direct line of light. With its Dimensions of 2"-3/4 - 70mm by 3"-3/8 - 85mm, Streamliner 70S has a more minimalistic look, while Streamliner 70L (2"-3/4 - 70mm by 4"-1/4 - 108mm) enables to hide away an emergency unit inside its body.

# STREAMLINER

[www.deltalight.us/streamliner-profile](http://www.deltalight.us/streamliner-profile)

[www.deltalight.ca/streamliner-profile](http://www.deltalight.ca/streamliner-profile)

#### FAMILY OVERVIEW

##### CHOOSE YOUR FINISH



Alu / Black / White

##### CHOOSE YOUR SETTING

Straight lines or with 90° corners

##### CHOOSE YOUR INSTALLATION

Recessed: with trim / trimless  
Surface mounted  
Suspended

##### CHOOSE YOUR LIGHT DISTRIBUTION

Down / Down-Up

##### CHOOSE YOUR OPTICS

Sandblasted / Prismatic

##### CHOOSE YOUR POWER

1900 lm/m / 3600 lm/m

##### CHOOSE YOUR COLOR TEMPERATURE

2700K / 3000K / 3500K / Tunable White

##### CHOOSE YOUR CONTROL

0-10V Dim / DALI Dim / Lutron ECO

##### CHOOSE YOUR EXTRA'S

Accent modules: Downlight

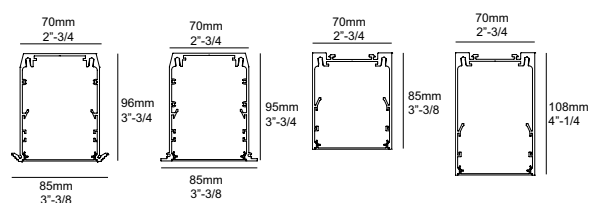

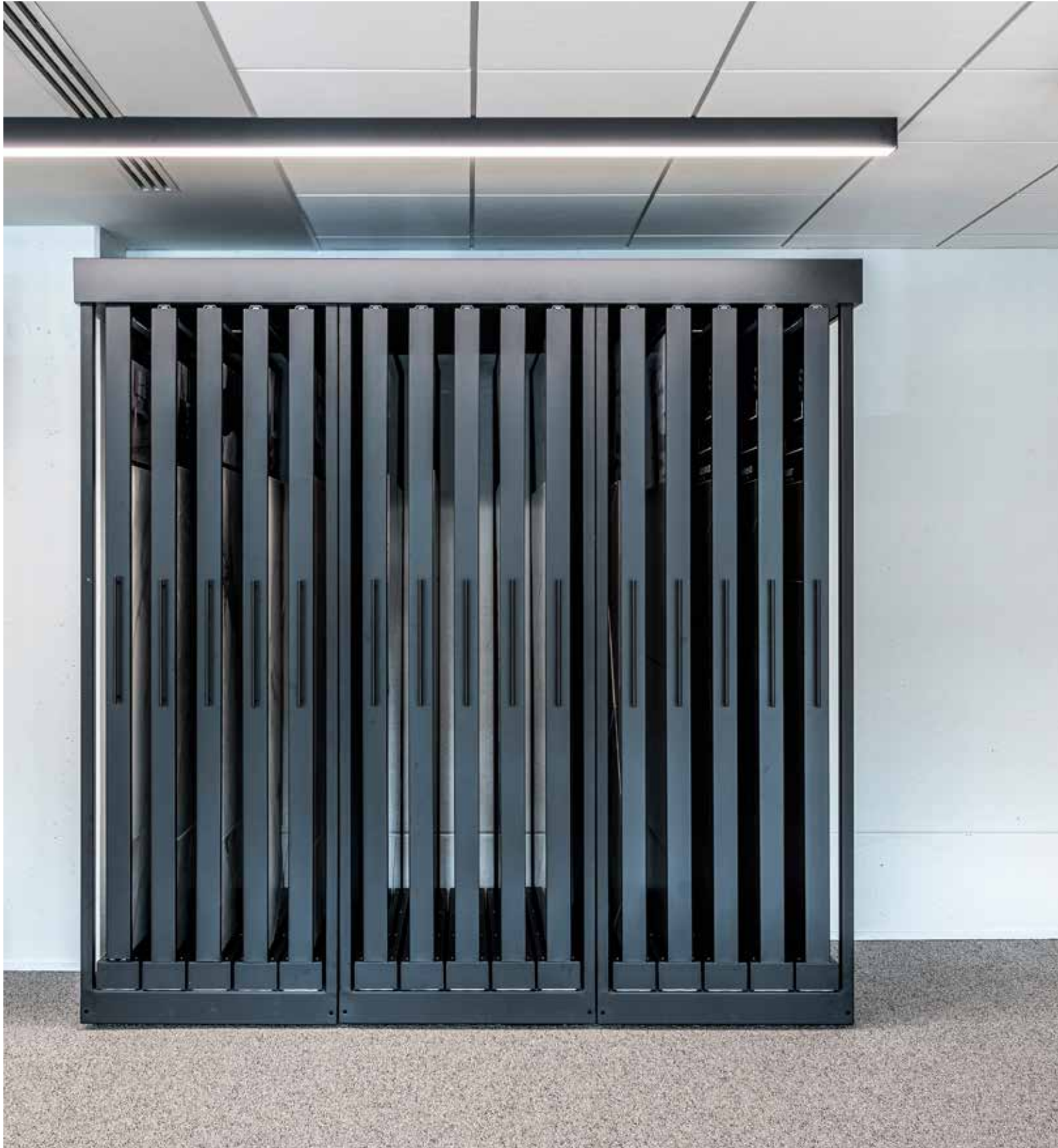



ARCHITECT STUDIO MEULENEERS KREFELD / PROJECT ALENA GIESSEN / PHOTOGRAPHY KIRSTEN BUCHER

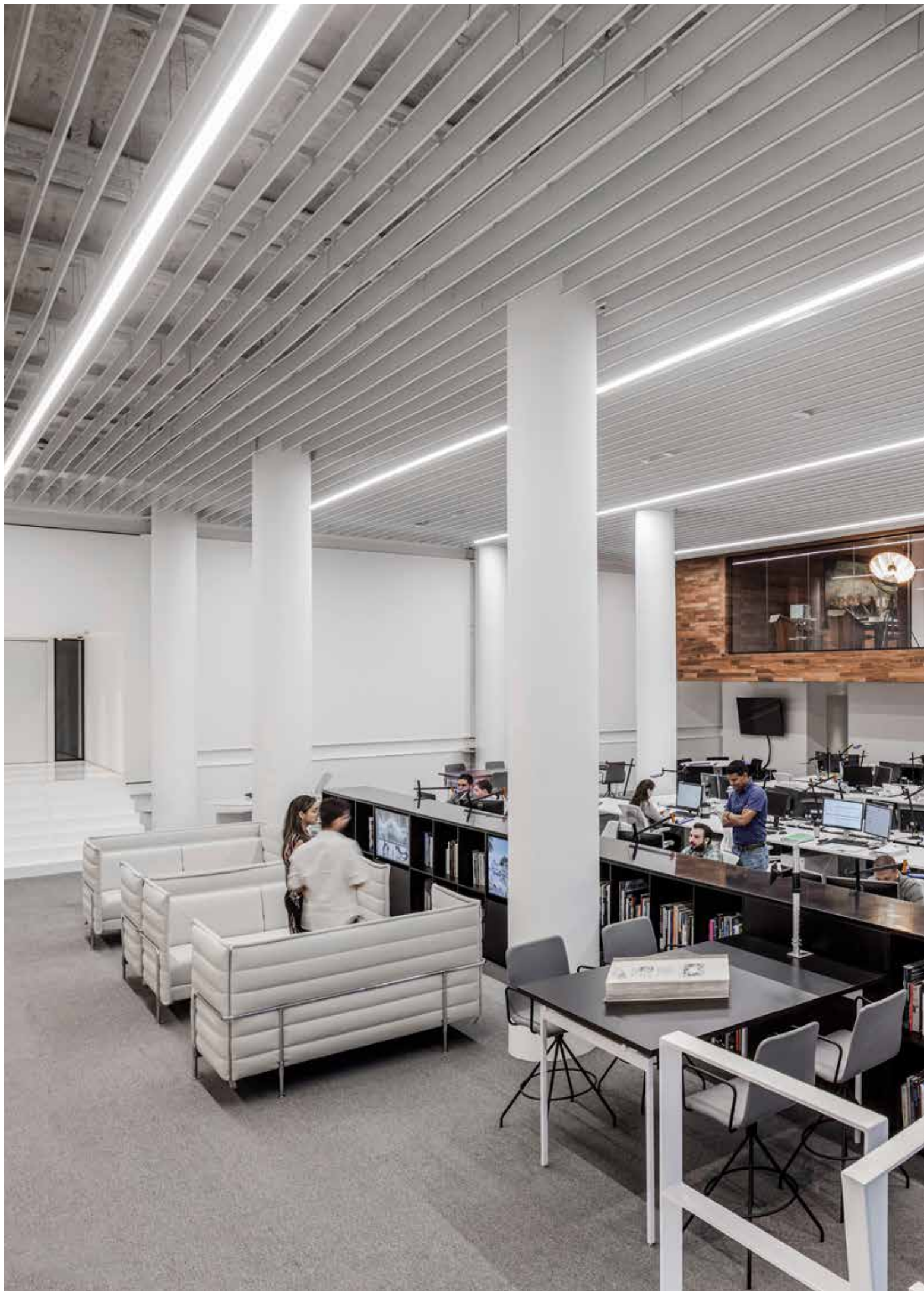

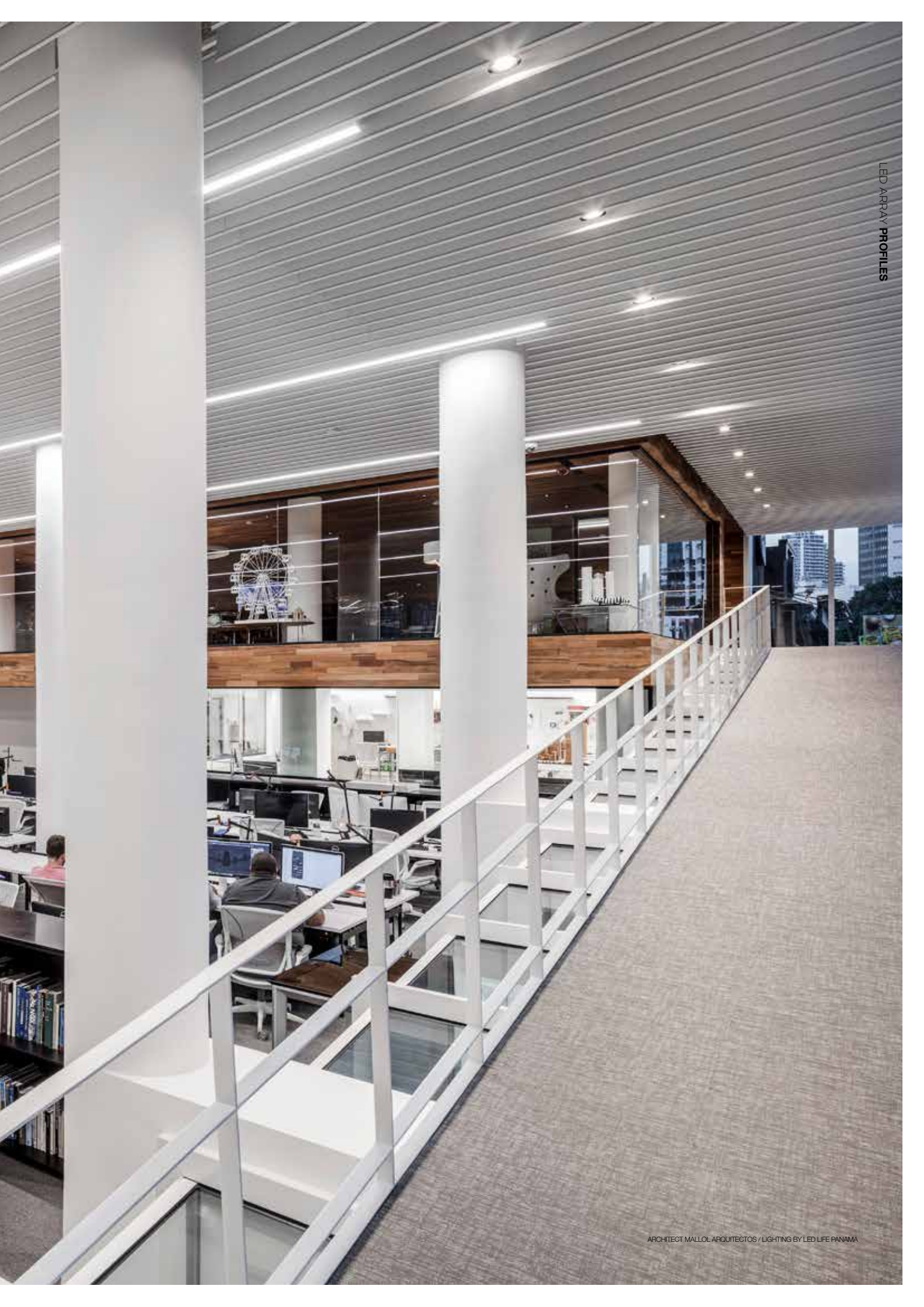

LED ARRAY PROFILES



ARCHITECT ATELIER LEYMARIE GOURDON / PHOTOGRAPHY BERTRAND FOMPEYRINE





ARCHITECT WALL ARCHITECTS / PHOTOGRAPHY IL'YA IVANOV



A series of miniature profiles, to be finished with the ledflex of your choice. Ideal to softly enlighten shelves, cupboards, wardrobes or for other indirect lighting applications.

# SHELFLINE

[www.deltalight.us/shelfline-profile](http://www.deltalight.us/shelfline-profile)  
[www.deltalight.ca/shelfline-profile](http://www.deltalight.ca/shelfline-profile)

**FAMILY OVERVIEW**

**CHOOSE YOUR FINISH**



Anodized

**CHOOSE YOUR INSTALLATION**

Recessed / Surface mounted

**POWER**

9W/m – 610lm/m

**CHOOSE YOUR COLOR TEMPERATURE**

2700K / 3000K / 3500K / 4000K

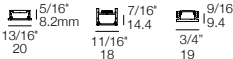



PROFILES PROFILES





EXTERIOR

# CEILING

# RECESSED

<p><b>NEW</b></p> <p><b>ENTERO</b> P 442</p> <p></p>   <p>790 - 3790lm</p> <p> 3 SIZES</p>	<p><b>NEW</b></p> <p><b>REO X</b> P 446</p> <p></p>  <p>780 - 1130lm</p> <p> 2 SIZES</p>	<p><b>NEW</b></p> <p><b>DEEP RINGO X</b> P 452</p> <p></p>  <p>780 - 1130lm</p> <p> 2 SIZES</p>	<p><b>NEW</b></p> <p><b>CARREE X</b> P 458</p> <p></p>  <p>810lm</p>
---	---	---	--

# SURFACE

**BOXY**

P 458



810 - 1620lm

EXTERIOR CEILING

LUMEN OUTPUT mentioned as indicative reach.

### RELIABILITY FOR XTERIOR USE.

The diversity within the Entero family makes it a versatile range, suitable for a multitude of applications and to fulfill various kinds of lighting needs. Apart from interior use, Entero can also be installed in exterior settings, this to create a uniform look and feel throughout the entire project. To ensure a hassle-free answer to these harsh environments, Entero X is designed to perfection in every detail.



- Waterproof IP65 luminaire thanks to seal out of EPDM rubber
- IK06 thanks to 4mm thick glass
- UV-resistant components for extended lifespan
- PC front cover for high impact & weather resistance
- Optimized flexibility: Tilting up to 20° & Rotating up to 355°
- Possibility to add accessories without opening the fixture



### FAMILY OVERVIEW

#### CHOOSE YOUR FINISH



Black / White

#### CHOOSE YOUR INSTALLATION

Trim  
Adjustable

#### CHOOSE YOUR SHAPE



Round / Square  
Small / Medium / Large

#### CHOOSE YOUR POWER

Small 5,8W up to 8,6W – 790 up to 1090lm  
Medium 11,6W up to 17,2W – 1520 up to 2100lm  
Large 11,3W up to 30,8W – 1630 up to 3790lm

#### CHOOSE YOUR OPTICS

Small 10° / 20° / 45°  
Medium 10° / 18° / 30°  
Large 10° / 18° / 30°

#### CHOOSE YOUR APPLICATION

New Construction

#### CHOOSE YOU CONTROL

0-10V / Phase Dimming /  
Lutron Eco / Lutron 2-Wire

#### CHOOSE YOUR COLOR TEMPERATURE

2700K / 3000K / 3500K / Soft Dim / Tunable White

#### CHOOSE YOUR ACCESSORY

Honeycomb / Glass SBL / Linear Spread Lens /  
Softening Lens / Spread Lens

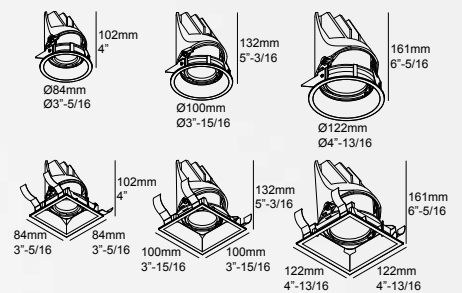



# Interior

Find the other members of this family **INTERIOR CEILING**

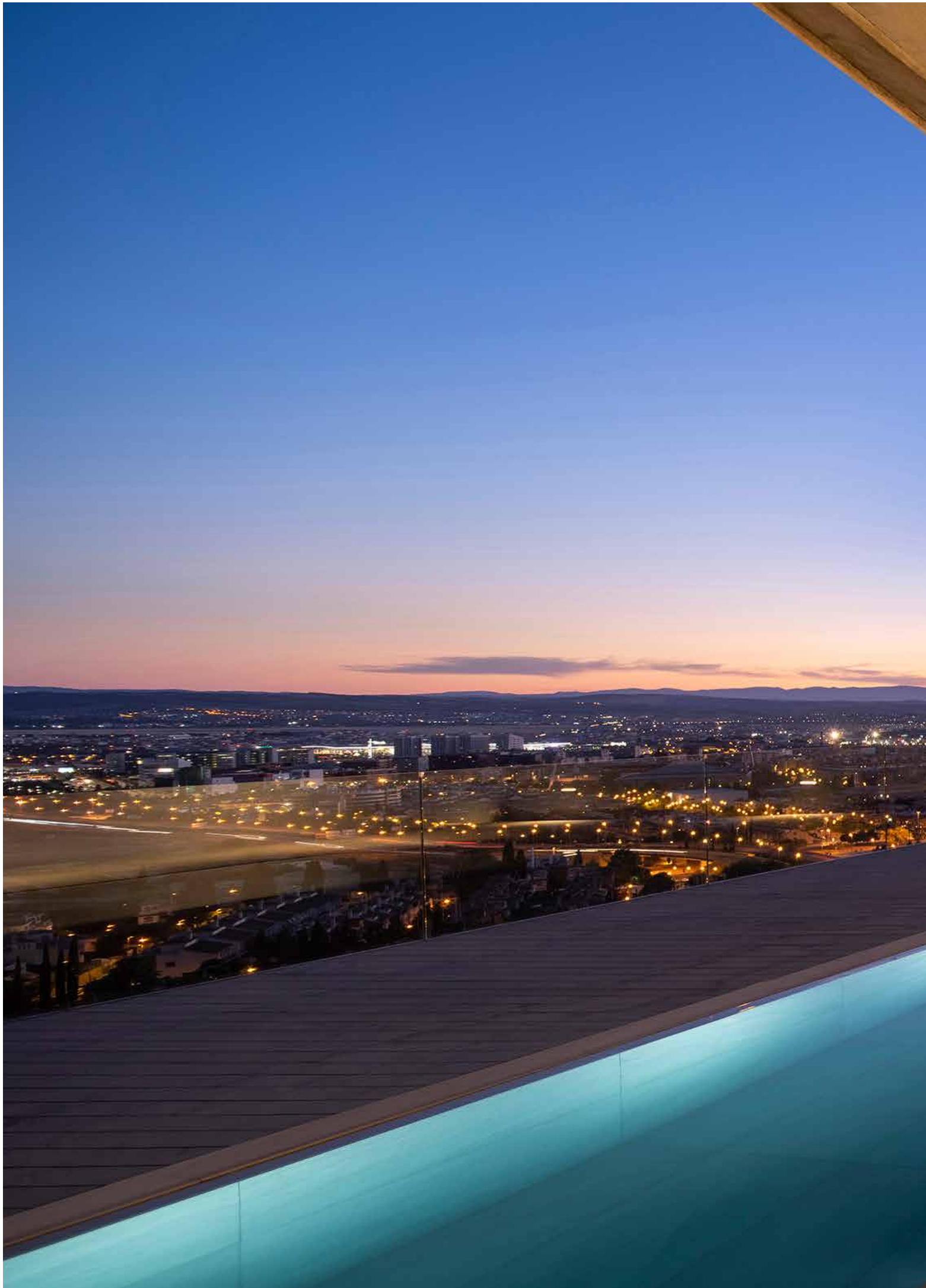

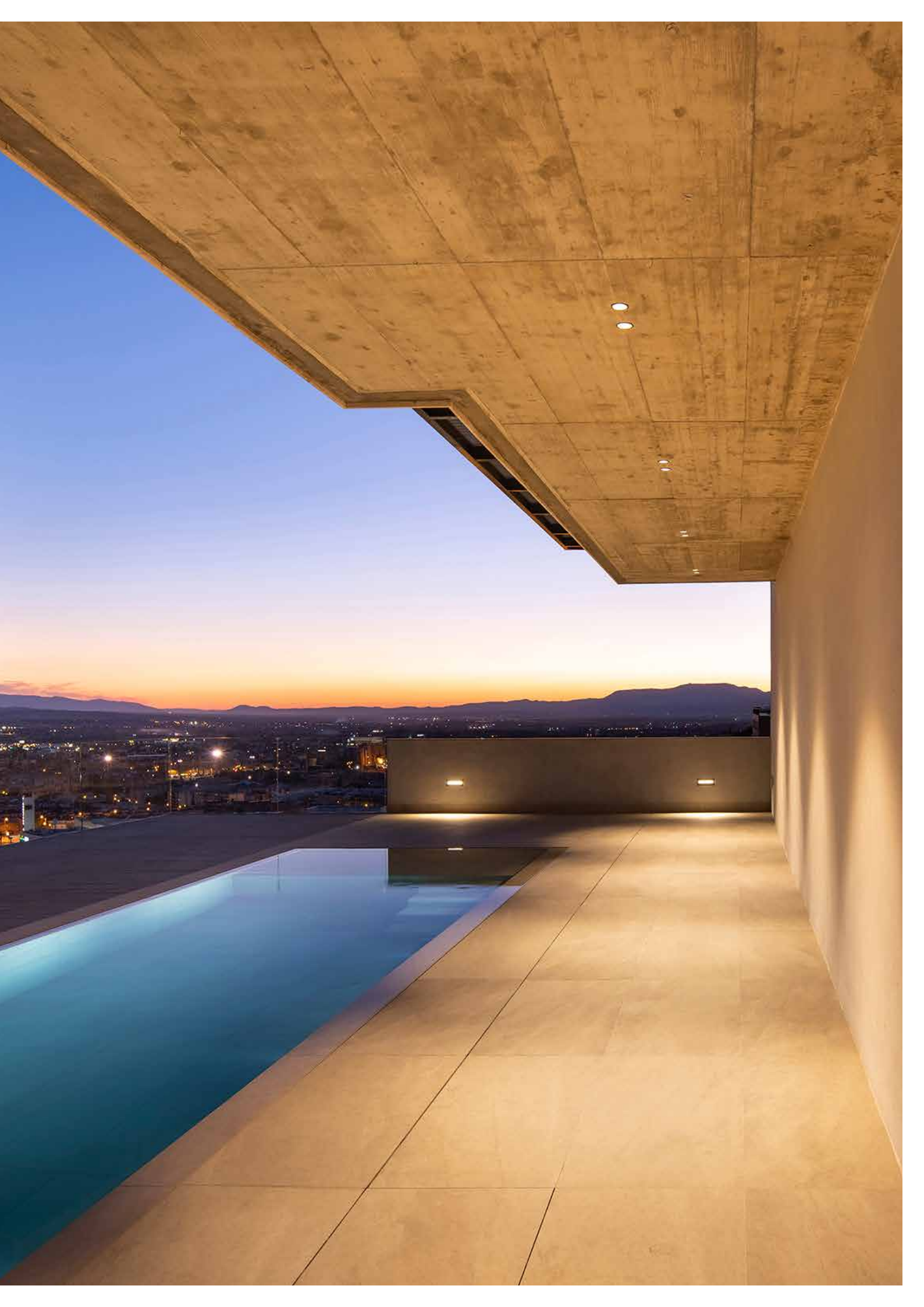



# REO X

The Reo collection is more than one product, it is a family which offers a solution for many lighting demands, from residential to hotel, restaurant to retail and much more. In line with this philosophy, Reo comes in single and double fixtures, round or square, orientable or fixed, in multiple finishing colors, for both indoor and outdoor use. The design of these recessed conical spots delivers a hardly visible transition from the intense light to the ceiling, resulting in a halo-like effect, ideal to give the space an extra dimension.

[www.deltalight.us/reo](http://www.deltalight.us/reo)  
[www.deltalight.ca/reo](http://www.deltalight.ca/reo)

## FAMILY OVERVIEW

### CHOOSE YOUR FINISH



Alu Grey / Black / White

### CHOOSE YOUR SIZE & POWER

Mini

6,1W up to 9W – 780 up to 1080lm

Reo

10.4W up to 15W - 1032lm to 1492lm

### CHOOSE YOUR COLOR TEMPERATURE

2700K / 3000K / 3500K

### CHOOSE YOUR OPTICS

Mini

37°

Reo

33°

### CHOOSE YOUR APPLICATION

Mini

New Construction

Remote Power Supply

Deep Ringo

New Construction

Remodel

### CHOOSE YOUR CONTROL

0-10V / Phase Dimming /

Lutron Eco

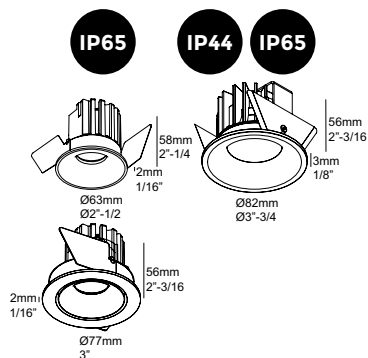



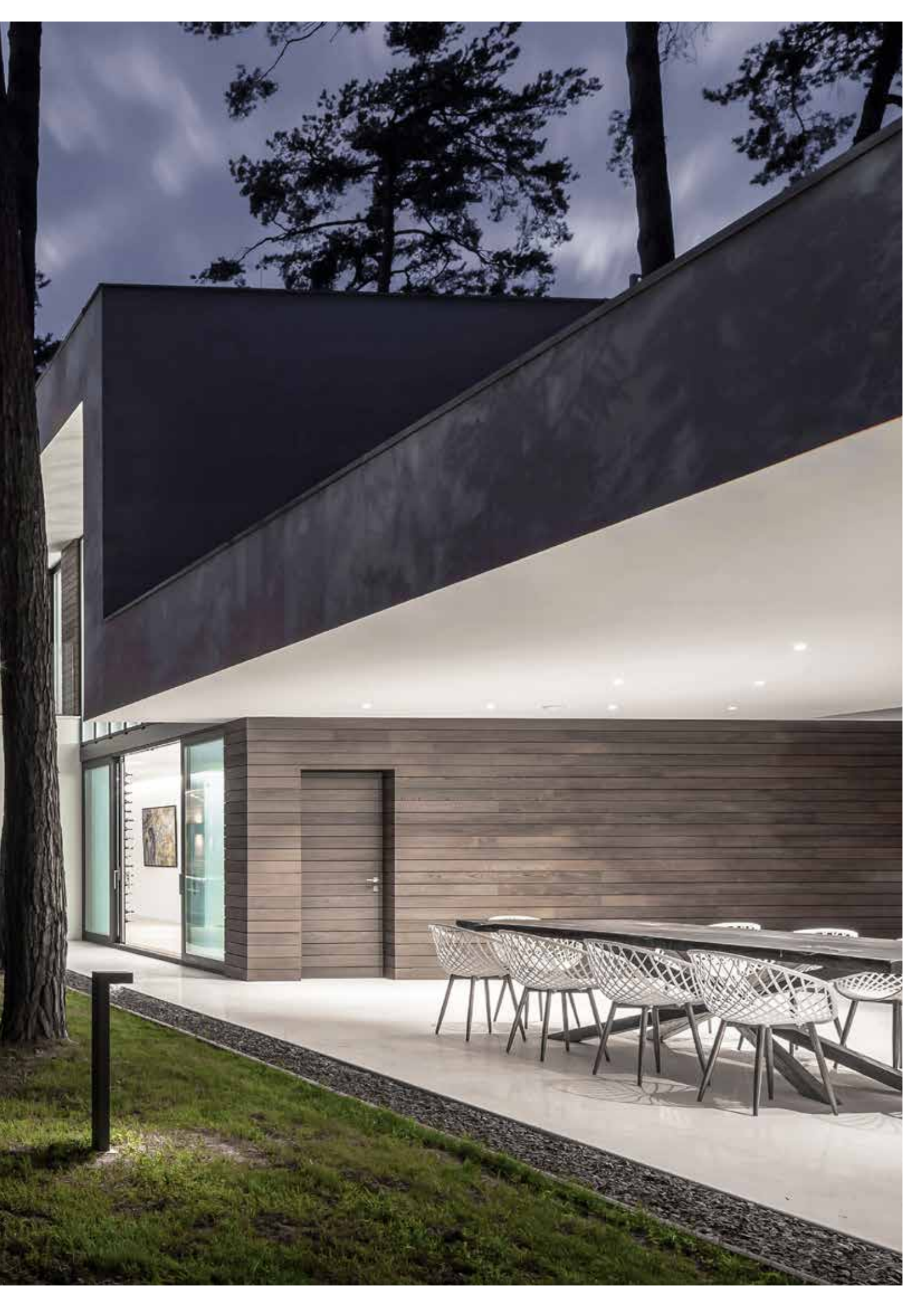







ARCHITECT CIP ARCHITEKTEN, STUTTGART / V8 HOTEL / PHOTOGRAPHY HG ESCH

# DEEP RINGO X

The conical shaped design of the Deep Ringo fixtures and the deeper placed LED source make sure that glare is reduced to a minimum when Deep Ringo is installed in the ceiling. The small trim gives a refined touch to this elegant luminaire.

[www.deltalight.us/deep-ringo](http://www.deltalight.us/deep-ringo)  
[www.deltalight.ca/deep-ringo](http://www.deltalight.ca/deep-ringo)

## FAMILY OVERVIEW

### CHOOSE YOUR FINISH



Black / White

### CHOOSE YOUR SIZE

Mini Deep Ringo II X

Deep Ringo X

### CHOOSE YOUR POWER

Mini

6,1W up to 9W – 780 up to 1080lm

Deep Ringo

7.1W up to 15W - 779 up to 1565lm

### CHOOSE YOUR COLOR TEMPERATURE

2700K / 3000K / 3500K

### CHOOSE YOUR OPTICS

Mini

37°

Deep Ringo

33°

### CHOOSE YOUR APPLICATION

Mini

New Construction  
Remote Power Supply

Deep Ringo  
New Construction  
Remodel

### CHOOSE YOUR CONTROL

0-10V / Phase Dimming /  
Lutron Eco

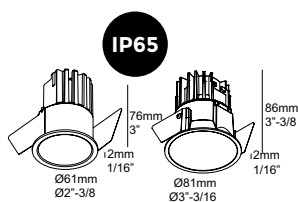

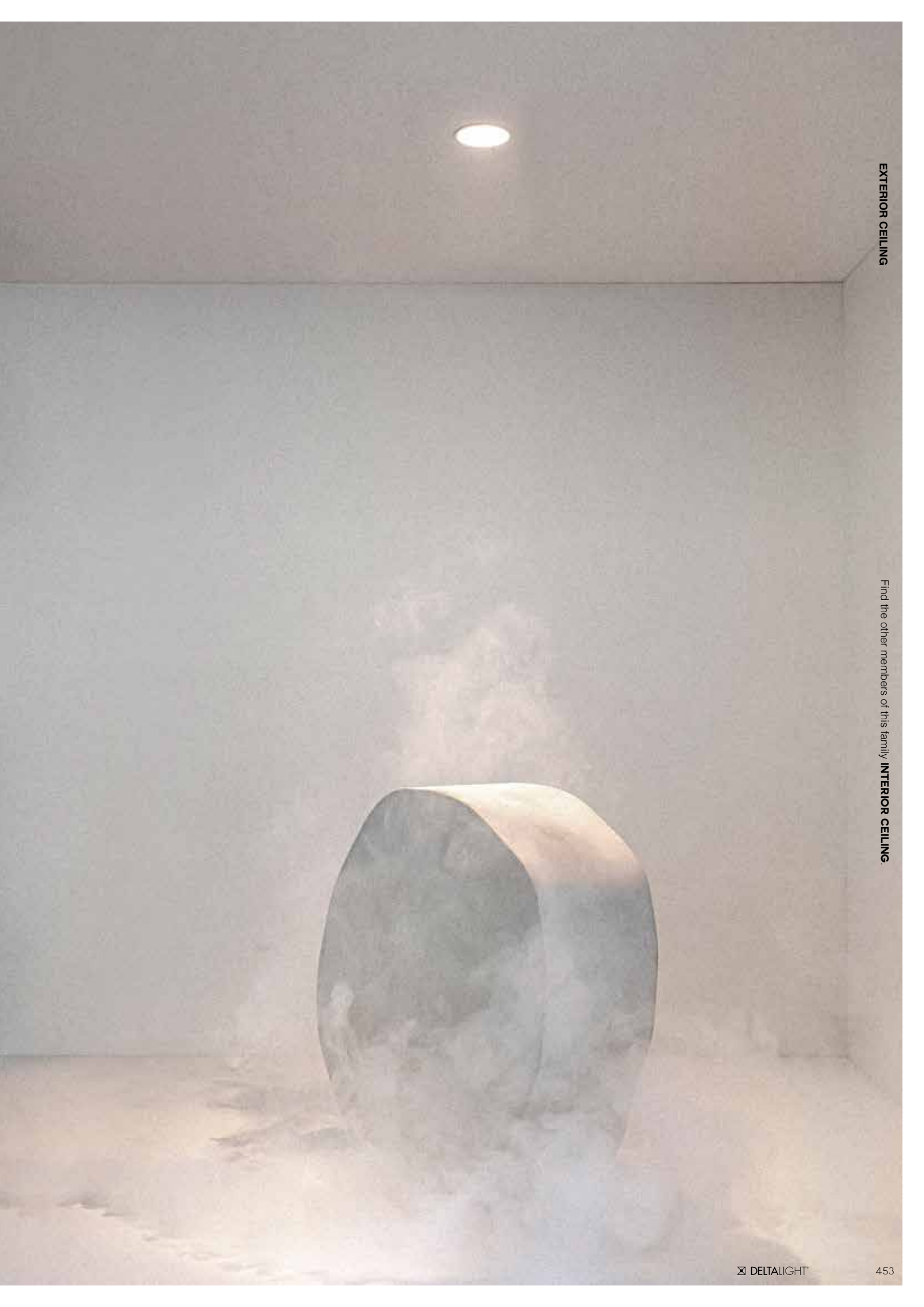

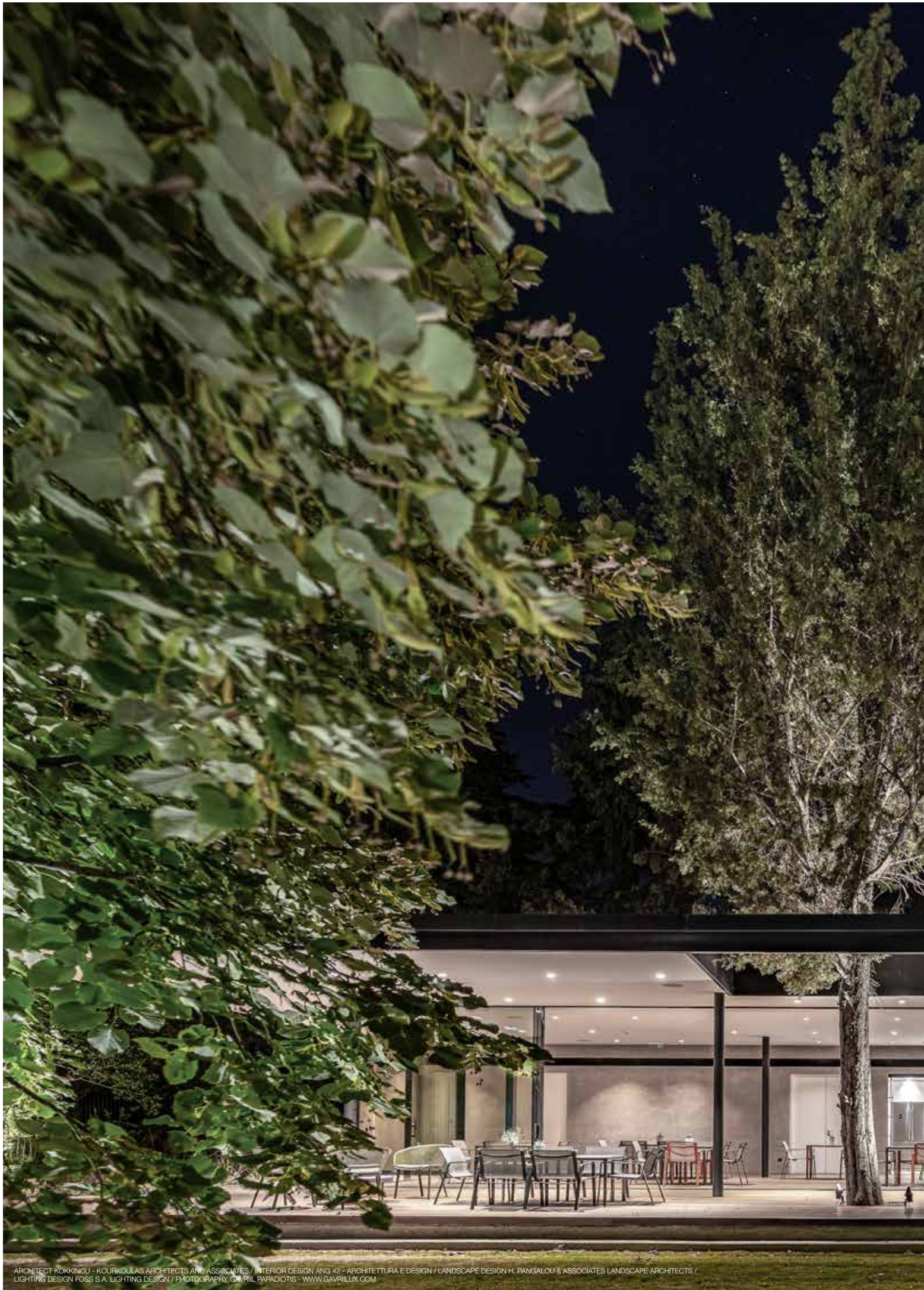





ARCHITECT GEORGE MORENO & PARTNERS / LIGHTING DESIGN LED LIFE PANAMA



# CARREE X

The Carree range is Delta Light's answer for easy-to-install, timeless and functional recessed spots, as it has been a Delta Light classic for many years.

This family of square recessed luminaires offers refined solutions for LED or halogen, either with or without trim. The straight lines in the design make a contemporary spot out of Carree, not only useful in modern architecture but also in many other applications.

Carree can be used throughout the entire project, as it also includes IP44 solutions for bathrooms and IP65 luminaires for outdoor use.

[www.deltalight.us/carree](http://www.deltalight.us/carree)  
[www.deltalight.ca/carree](http://www.deltalight.ca/carree)



## FAMILY OVERVIEW

### CHOOSE YOUR FINISH



Alu Grey / Dark Grey / White

### POWER

10.4W up to 15W - 1032 up to 1492lm

### CHOOSE YOUR COLOR TEMPERATURE

2700K / 3000K / 3500K

### OPTICS

33°

### CHOOSE YOUR APPLICATION

New Construction  
Remodel

### CHOOSE YOUR CONTROL

0-10V / Phase Dimming /  
Lutron Eco

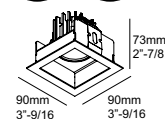



EXTERIOR CEILING



Find the other members of this family **INTERIOR CEILING**.





#### FAMILY OVERVIEW

#### CHOOSE YOUR FINISH



Black / White / White-Black

#### POWER

10,4W - 1120lm

#### CHOOSE YOUR COLOR TEMPERATURE

2700K / 3000K / 3500K

#### OPTICS

33°

#### CHOOSE YOUR CONTROL

Phase Dimming

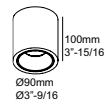

# BOXY

Boxy is a cylindrical mounted luminaire with a deeper recessed LED module with a conical, colored insert in front. While the deeper recessed LED module reduces the glare, the choice in color creates possibilities for playful and attractive lighting solutions.

This family offers indoor and outdoor luminaires, a perfect solution when recessing is not an option.

[www.deltalight.us/boxy](http://www.deltalight.us/boxy)  
[www.deltalight.ca/boxy](http://www.deltalight.ca/boxy)

EXTERIOR CEILING



Find the other members of this family **INTERIOR CEILING**.

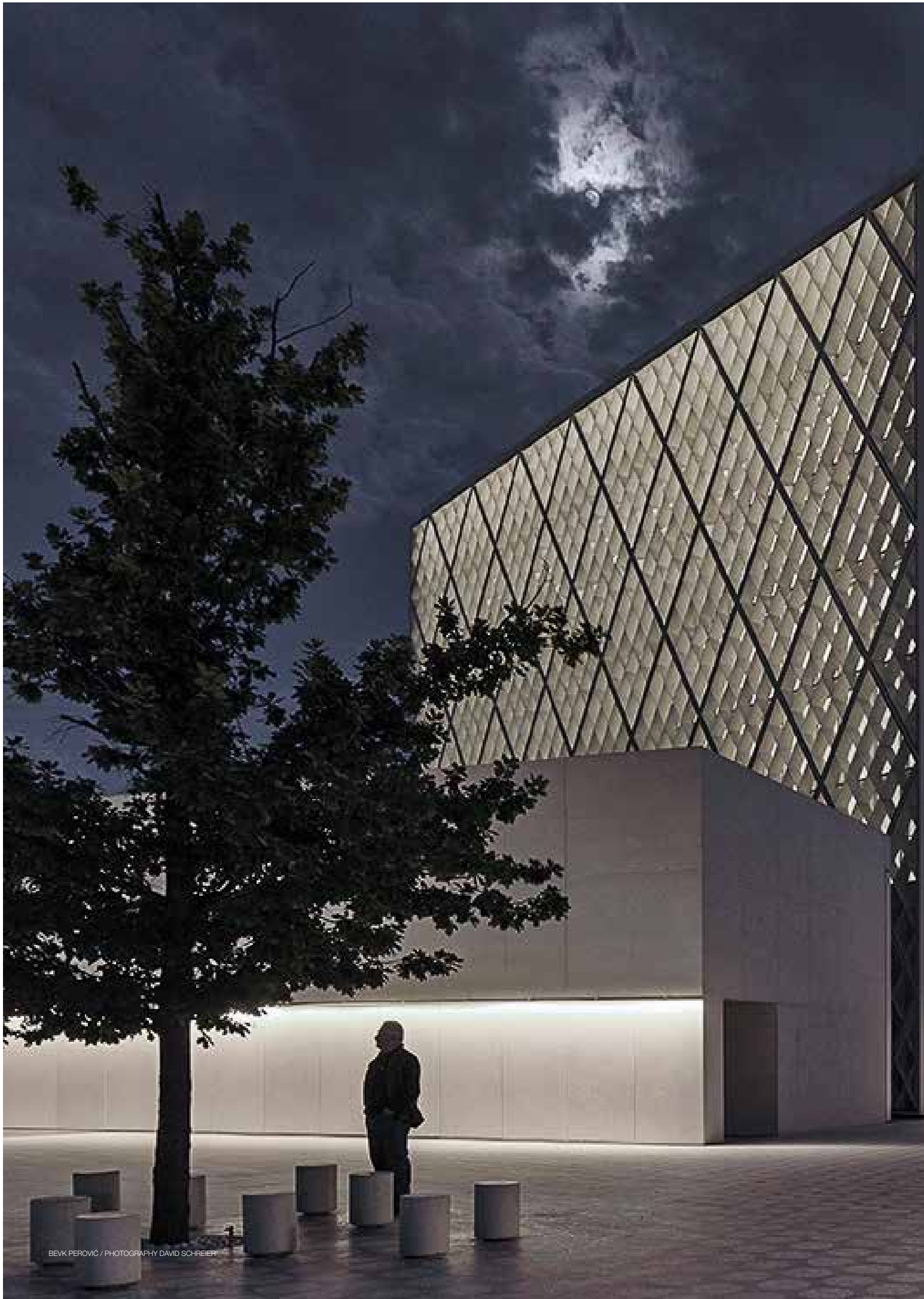









ABCABC

ZEEBRUGGE

BRUGGE CRUISE



EXTERIOR

**WALL**



# RECESSED

## LOGIC W

P 470



## LEDS C / GO

P 476

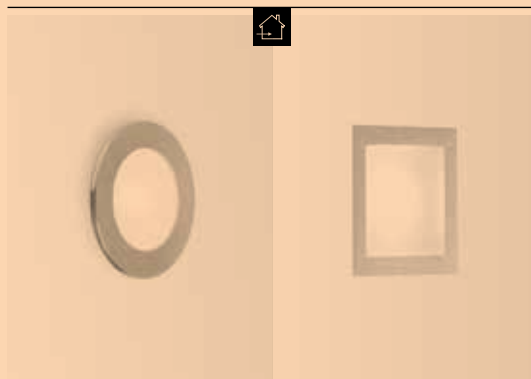

## HELI

P 480



# SURFACE

**TOPIX**

P 486



**TIGA**

P 494



**MOMBA**

P 498



**MONO II**

P 598



**NEW**

**WALKER II**

P 490



2 SIZES

**MONTUR**

P 506

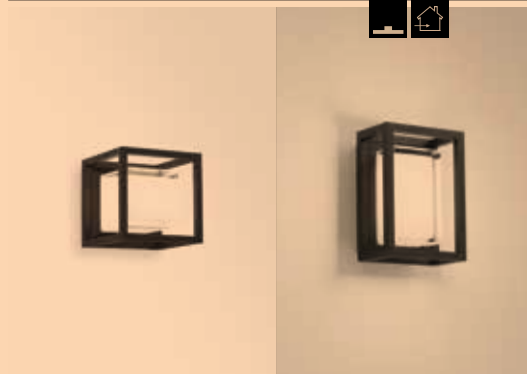

# LOGIC W

As a family of guidance lights, Logic W exists out of small and large wall luminaires to be installed slightly above ground level. As such, they provide a soft glow on the floor to guide you along pathways or in corridors, both in- and outdoors.

[www.deltalight.us/logic-w](http://www.deltalight.us/logic-w)  
[www.deltalight.ca/logic-w](http://www.deltalight.ca/logic-w)

## FAMILY OVERVIEW

### CHOOSE YOUR FINISH



Alu Grey / Dark Grey / White

### CHOOSE YOUR SHAPE & SIZE



Round / Square / Rectangular

Small / Large

### CHOOSE YOUR POWER

Small

0,6W - 40lm

Large

7,1W up to 9W - 800 up to 1480lm

### COLOR TEMPERATURE

3000K

IP54

IP65

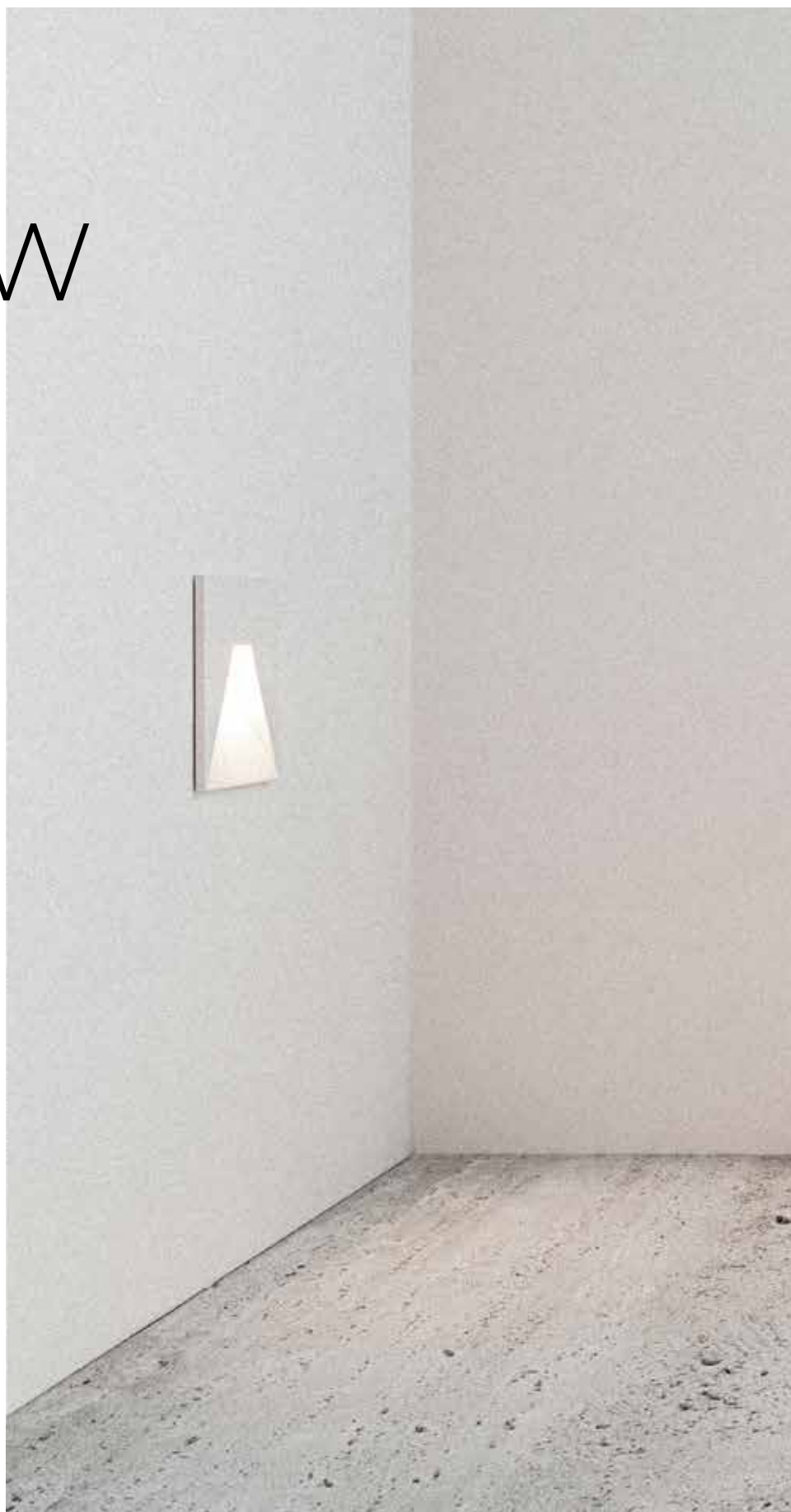
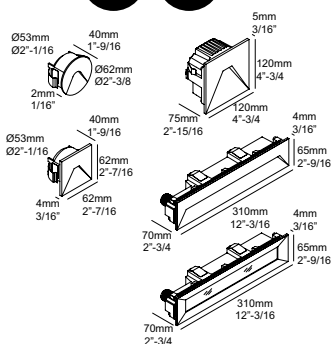





DEHULLU ARCHITECTEN



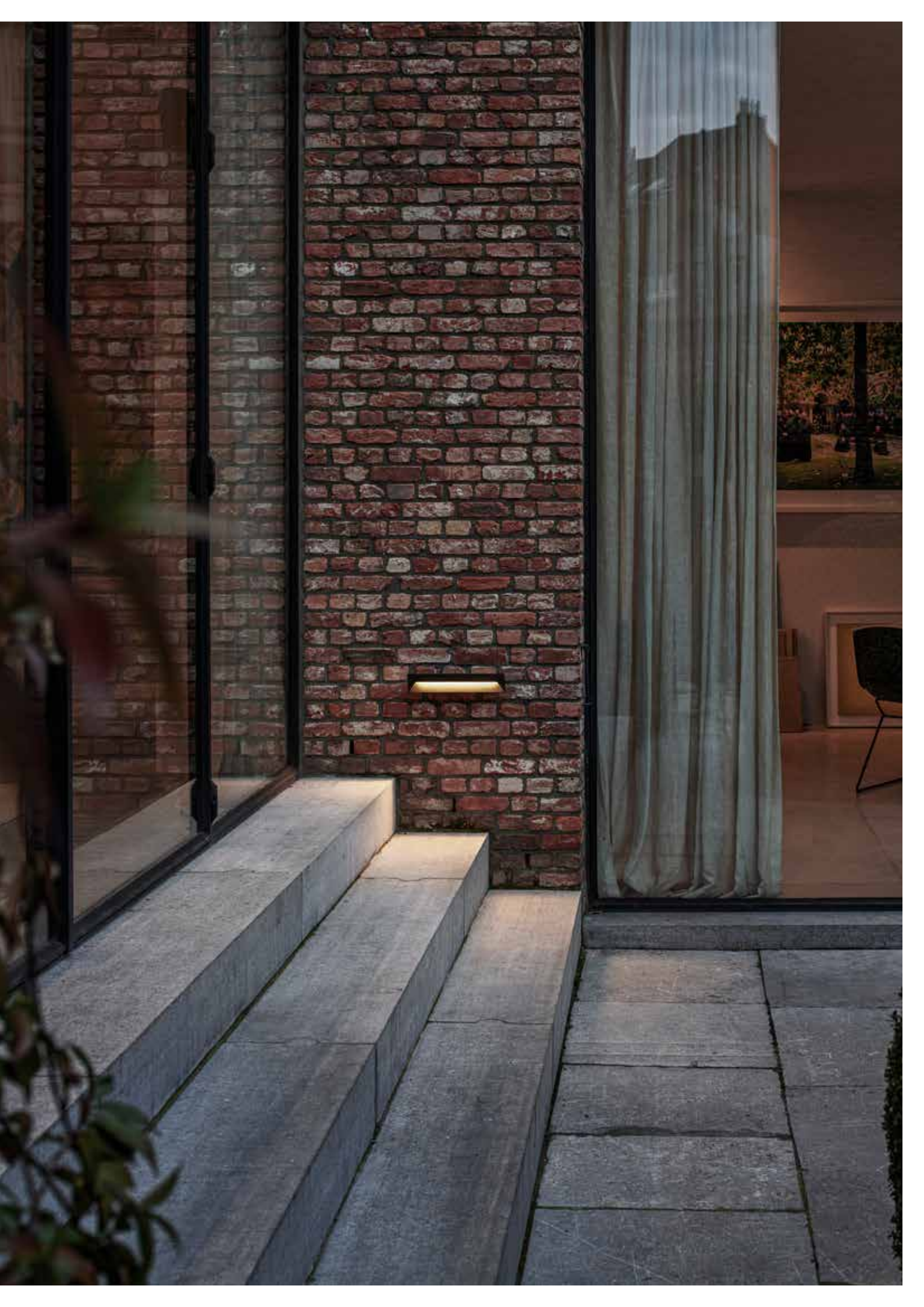

# LEDS C / GO

This family offers some miniature fixtures that serve as orientation and atmosphere lighting. Available in round and square, these little dots of light are perfect as guidance lights. While Leds C II can be used indoors - for example as safety light in corridors and hallways -, Leds C R ST and Leds Go will guide the way outdoors - along paths and driveways.

[www.deltalight.us/leds-c](http://www.deltalight.us/leds-c)  
[www.deltalight.ca/leds-c](http://www.deltalight.ca/leds-c)

[www.deltalight.us/leds-go](http://www.deltalight.us/leds-go)  
[www.deltalight.ca/leds-go](http://www.deltalight.ca/leds-go)



## FAMILY OVERVIEW

### CHOOSE YOUR FINISH



Anodized aluminium

### POWER

1,1W – 130lm

### CHOOSE YOUR COLOR TEMPERATURE

3000K / 4000K

**IP67**

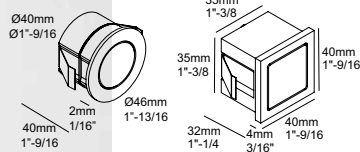

EXTERIOR WALL

Find the other members of this family **INTERIOR WALL / EXTERIOR FLOOR**

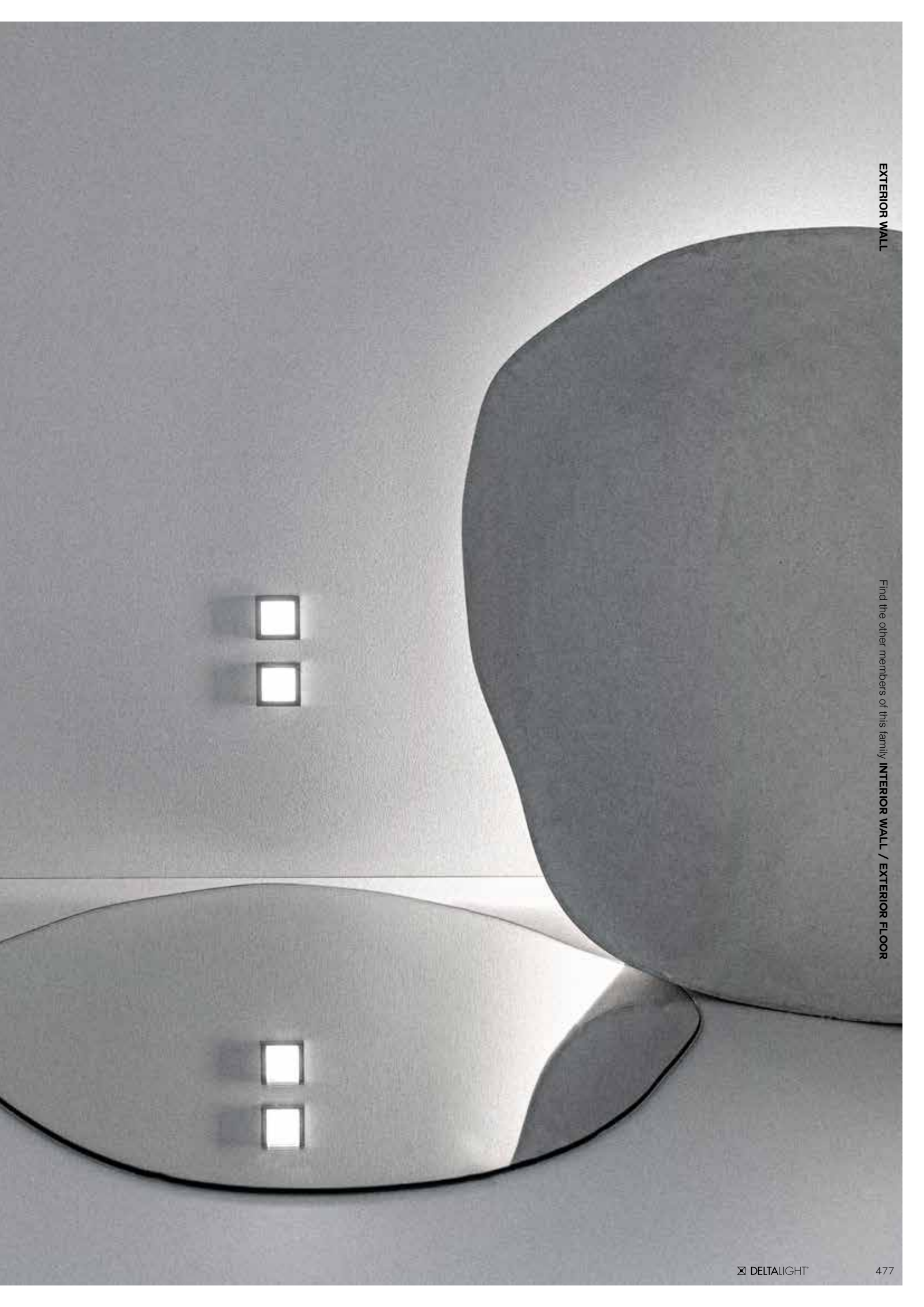





# HELI X

As a small wall recessed luminaire, Heli is perfect as a guidance light. Be it in a corridor or as a safety light for the steps of your stairs at night, Heli does the trick. Also outside, Heli X will guide you the way.

[www.deltalight.us/heli](http://www.deltalight.us/heli)  
[www.deltalight.ca/heli](http://www.deltalight.ca/heli)





**FAMILY OVERVIEW**

**CHOOSE YOUR FINISH**



Alu Grey / Dark Grey

**POWER**

1,1W - 130lm

**CHOOSE YOUR COLOR TEMPERATURE**

3000K / 4000K

**IP54**

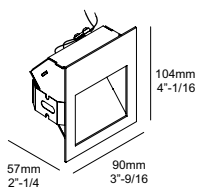







EXTERIOR WALL

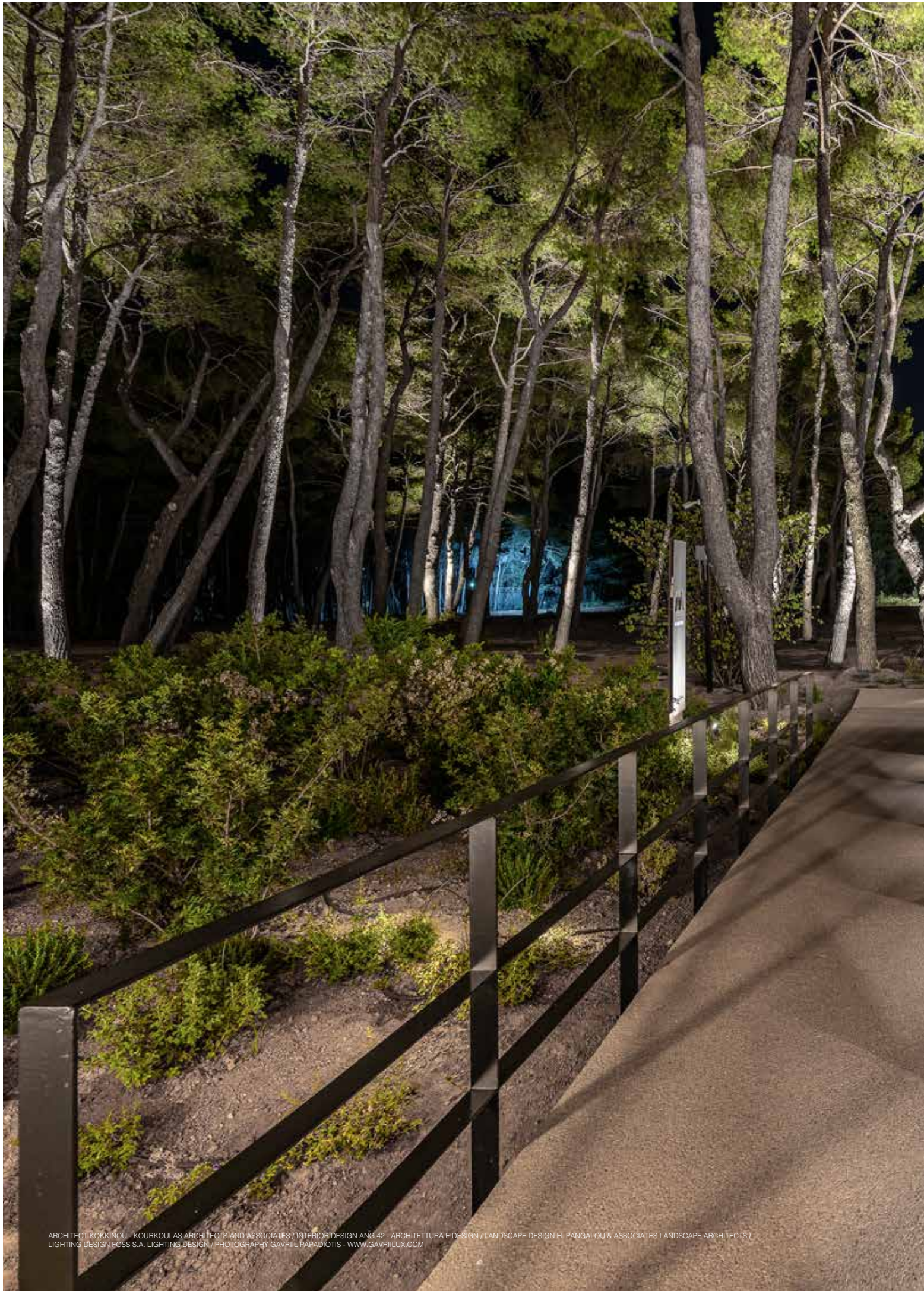

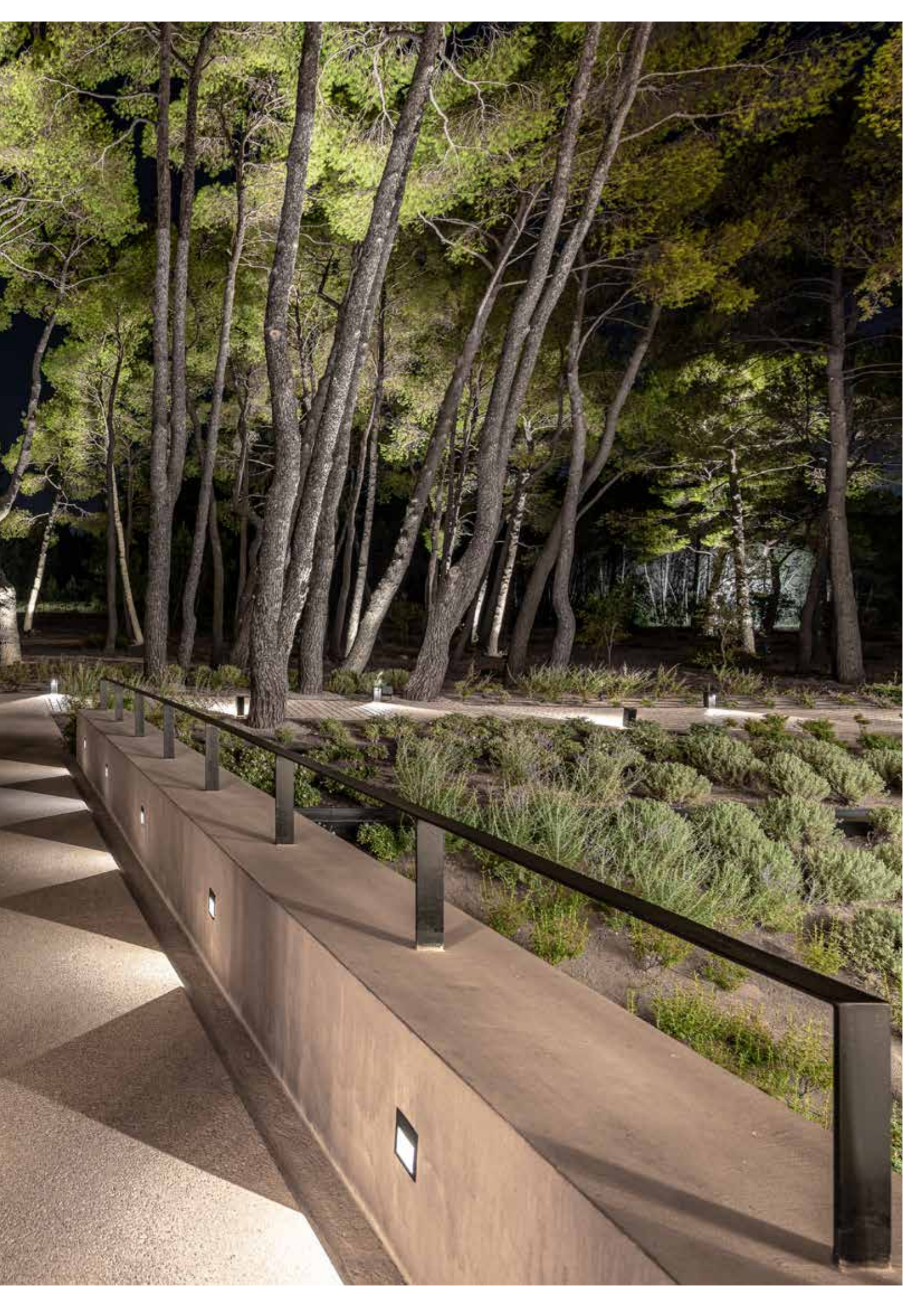



# TOPIX

This multi award-winning luminaire ensures a playful effect and offers a lot of freedom. On its own, Topix wows you with its peculiar yet attractive design, when put together, you can create artistic clusters of light. Topix comes for in- and outdoors, giving you the opportunity to make your façade stand out.

[www.deltalight.us/topix](http://www.deltalight.us/topix)  
[www.deltalight.ca/topix](http://www.deltalight.ca/topix)

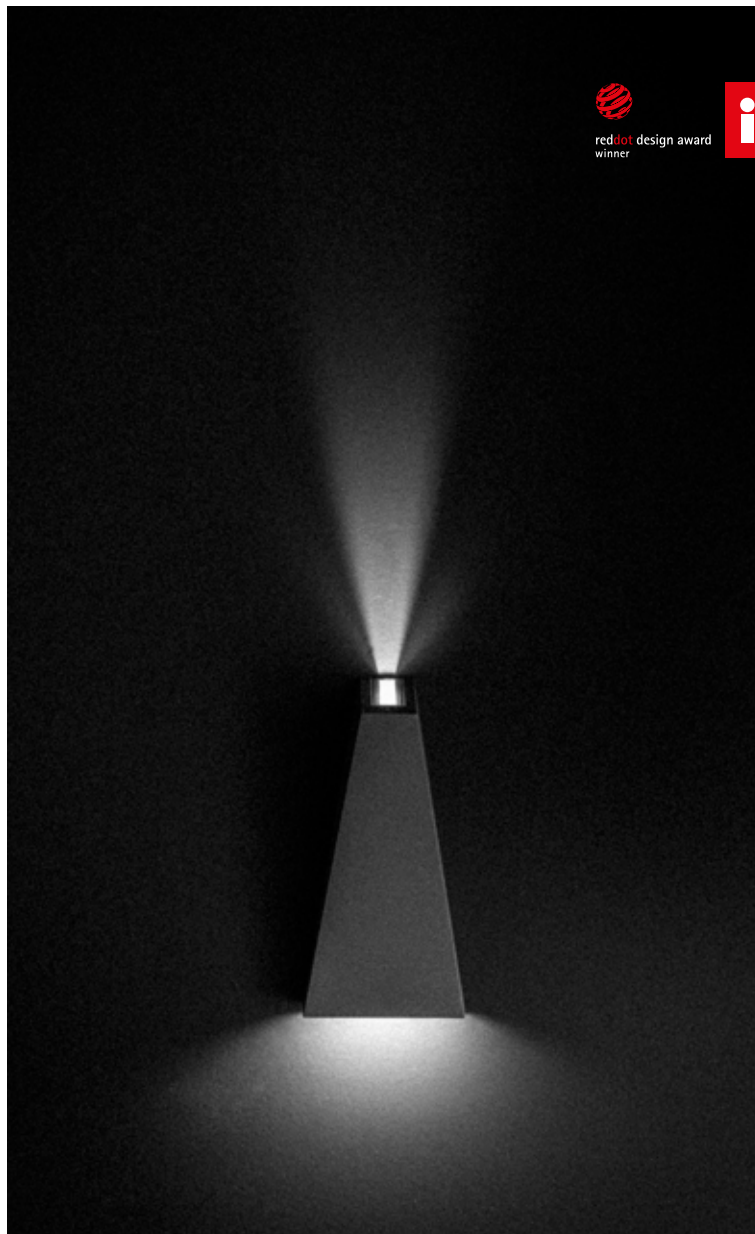

## FAMILY OVERVIEW

### CHOOSE YOUR FINISH



Alu Grey / Grey Brown

### POWER

2 x 3,5W - 270lm

### CHOOSE YOUR COLOR TEMPERATURE

3000K

### FIXATION

Mud Kit

**IP55**

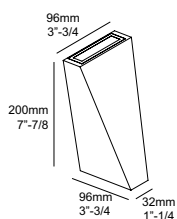



M2 ARCHITECTURAL GROUP, ALEXANDER ZHIDKOV



# WALKER II

## **SPLIT THE LIGHT**

Walker II splits the light open. Starting from 1 light source, Walker II is designed to guide the light into two directions to provide a double light effect on the surface below.

The light falls on the V-shaped inner part of the luminaire, breaking it open and throwing it to the front- and backside of the luminaire.

Walker II can serve as a guiding light on your wall or pathway, as it comes as a wall luminaire and as a bollard.

Different sizes, different heights and multiple color combinations can be combined to your preference to create the perfect setting.

[www.deltalight.us/walker-ii](http://www.deltalight.us/walker-ii)

[www.deltalight.ca/walker-ii](http://www.deltalight.ca/walker-ii)





**FAMILY OVERVIEW**

**CHOOSE YOUR FINISH**



Alu Grey / Dark Grey  
Alu Grey-Dark Grey / Dark Grey-Gold Colored

**CHOOSE YOUR POWER**

3,7W - 480lm / 6,2W - 790lm

**CHOOSE YOUR COLOR TEMPERATURE**

2700K / 3000K

**CONTROL**

Non Dim

**FIXATION**

Coverplate

**IP54**

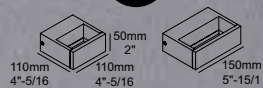



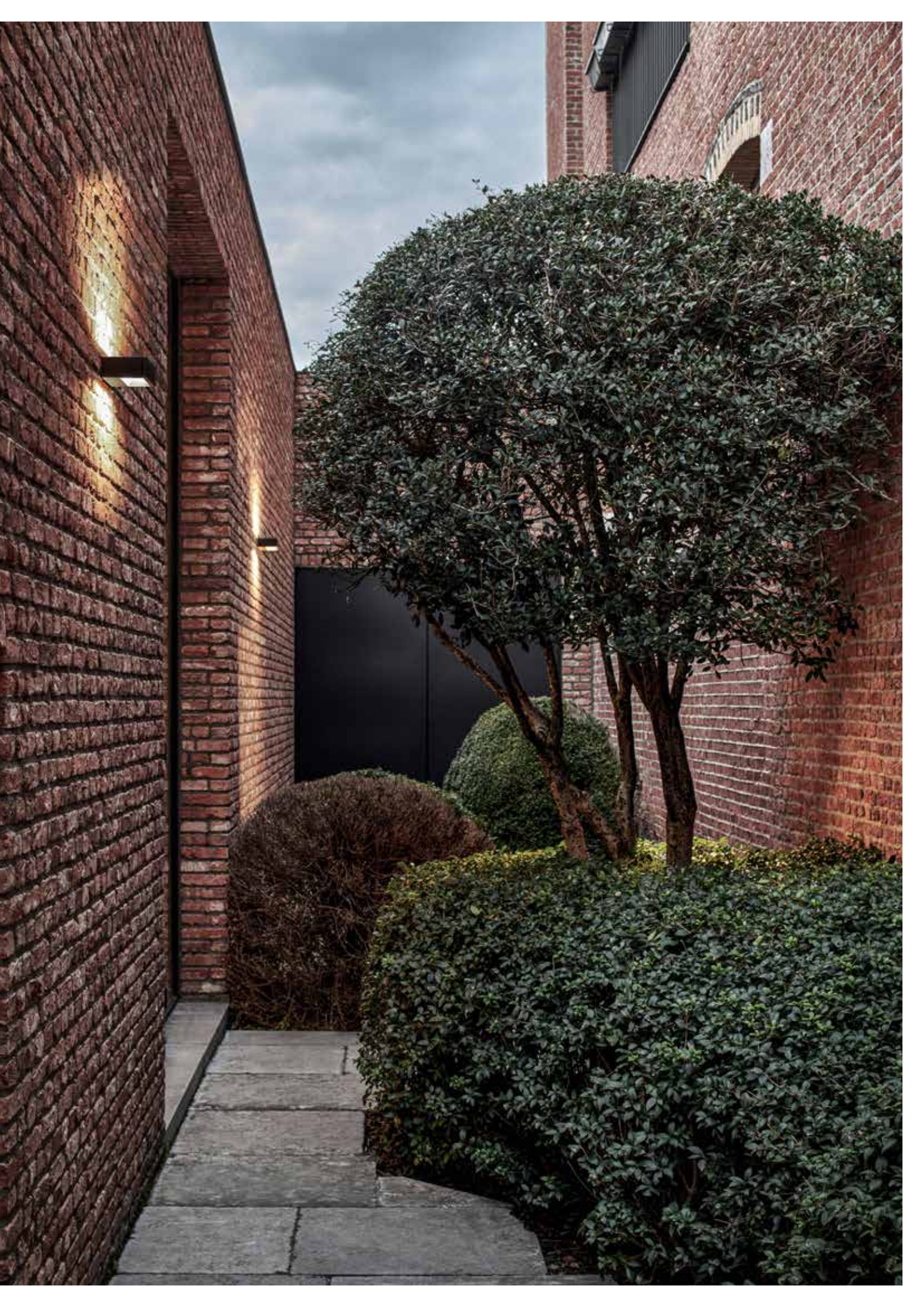

# TIGA

A medium sized rectangular lighting fixture, delivering a pleasant up and downward light effect on your wall. As a surface mounted wall unit, Tiga is perfect for both residential use or for hospitality usage in hotels and restaurants. Standard, Tiga creates a wide beam effect for both down- and uplight, while Tiga BS allow you to play with a combination of a wide and small beam effect within 1 luminaire. Despite its IP65 rating for outdoor use, this unit also feels very comfortable when used indoors.

[www.deltalight.us/tiga](http://www.deltalight.us/tiga)  
[www.deltalight.na/tiga](http://www.deltalight.na/tiga)



## FAMILY OVERVIEW

### CHOOSE YOUR FINISH



Alu Grey / Grey Brown / White

### CHOOSE YOUR LIGHT EFFECT

Wide beam for both down & up

Wide + Small beam combination

### POWER

7,1W - 810lm

### CHOOSE YOUR COLOR TEMPERATURE

2700K / 3000K / 3500K

### CHOOSE YOUR CONTROL

Non Dim

IP65

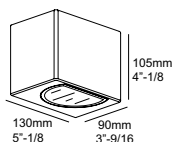

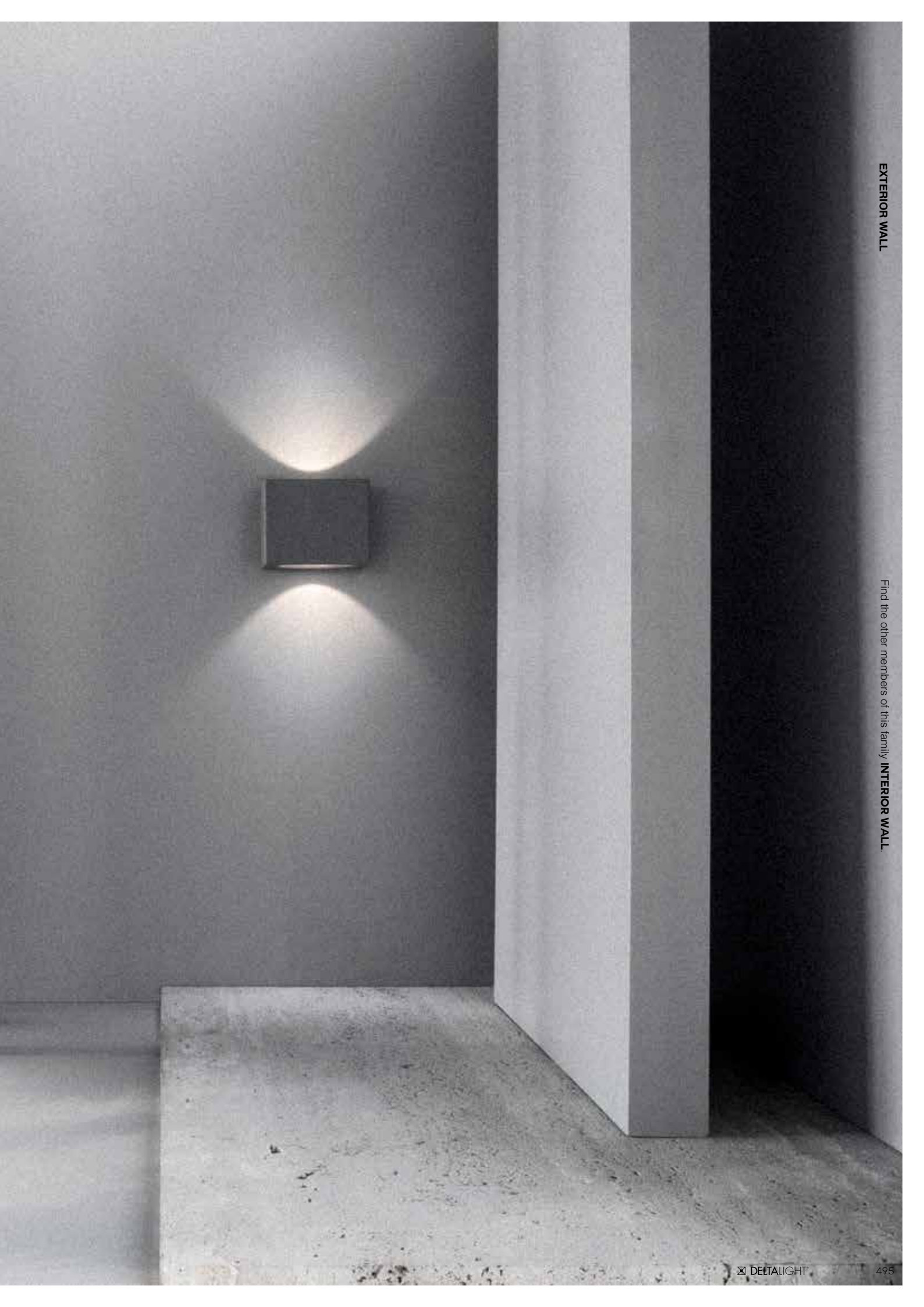

EXTERIOR WALL

Find the other members of this family **INTERIOR WALL.**





EXTERIOR WALL

# MOMBA

At first sight, Momba looks very straightforward. But despite its simple looks, Momba offers more than meets the eye. Its outer shell shows some sophisticated detailing, visible in the rounded corners and its optical compartment. The convex lenses create a small line of light or a general wide beam, as downlight only or down-up light.

[www.deltalight.us/momba](http://www.deltalight.us/momba)  
[www.deltalight.ca/momba](http://www.deltalight.ca/momba)

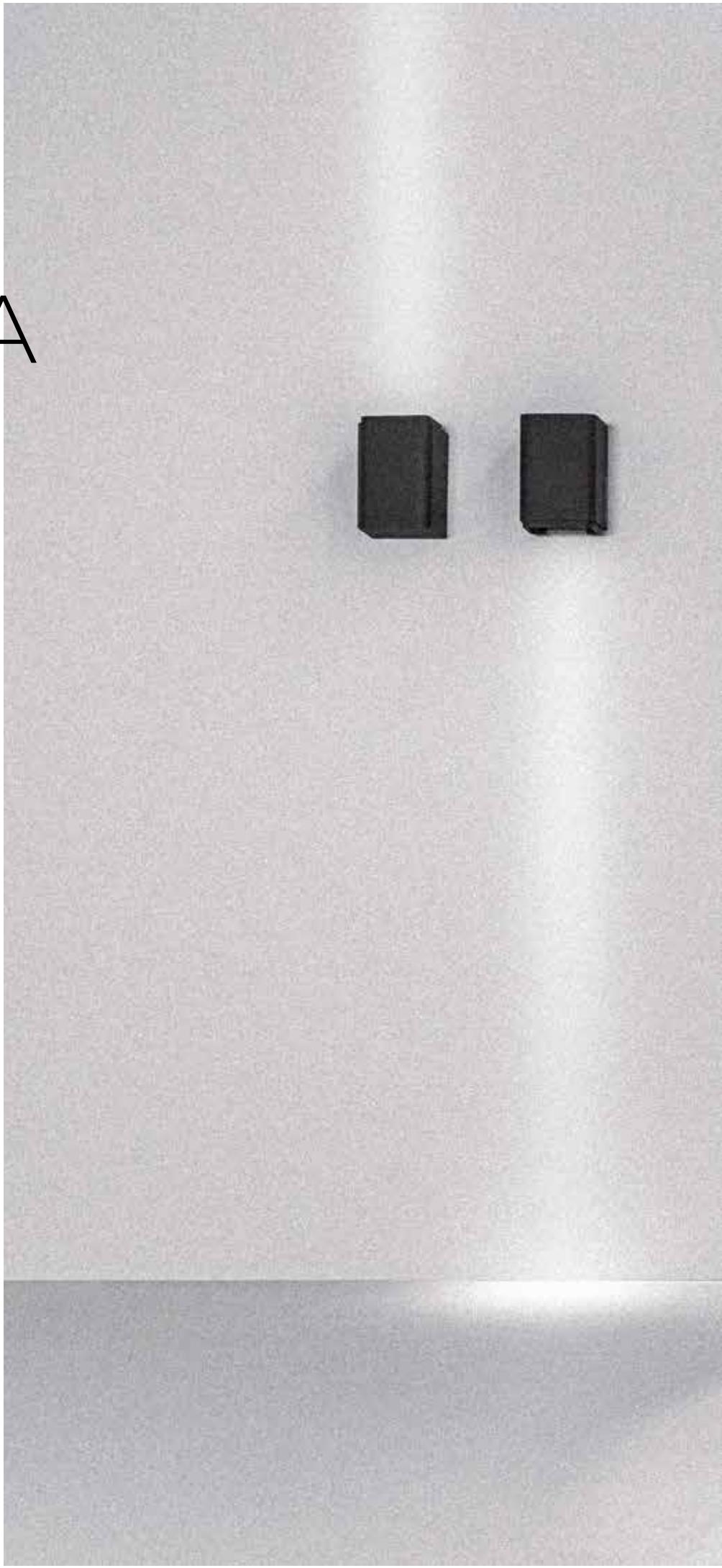

## FAMILY OVERVIEW

### COLOR



Dark Grey

### CHOOSE YOUR LIGHT EFFECT

Down / Down-Up

Wide beam / Small beam

### POWER

Down

2W up to 7,1W – 245 up to 810lm

Down-Up

2 x 2W up to 7,1W – 245 up to 810lm

### CHOOSE YOUR COLOR TEMPERATURE

3000K / 3500K

### CONTROL

Non Dim

### CHOOSE YOUR LED FIXATION

Mud Kit / Coverplate

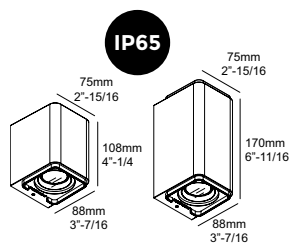



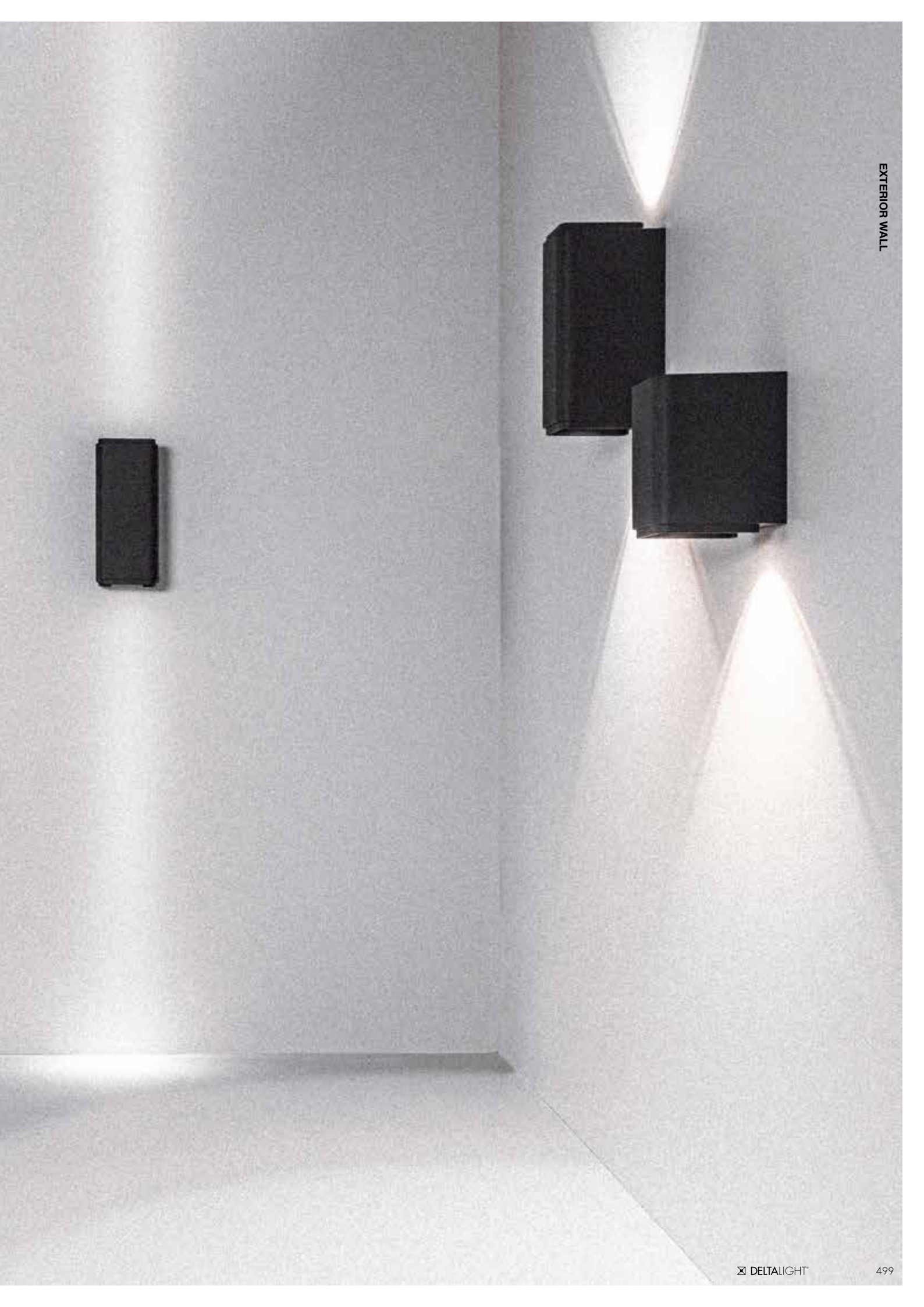





# MONO II

Mono is a well-known member of the Delta Light outdoor range. It was the first outdoor wall fixture within the range that combines a LED module with a lens, resulting in a far-reaching and strongly delineated lighting effect. The Mono's timeless and sharp contoured design adds a contemporary touch to any façade.

[www.deltalight.us/mono-ii](http://www.deltalight.us/mono-ii)  
[www.deltalight.ca/mono-ii](http://www.deltalight.ca/mono-ii)

## FAMILY OVERVIEW

### COLOR



Alu Grey / Dark Grey

### CHOOSE YOUR LIGHT EFFECT

Down / Down-Up

### POWER

Down

7,1W – 810lm

Down-Up

2 x 7,1W – 810lm

### CHOOSE YOUR COLOR TEMPERATURE

3000K / 3500K

### CHOOSE YOUR LED FIXATION

Mud Kit / Coverplate

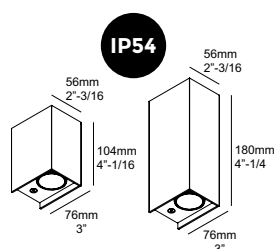









# MONTUR

With Montur we offer a highly original interpretation of an archetypical concept: a light source that is contained within the framing of a 3D square or rectangular shape. The Montur is available in indoor and outdoor versions, as a ground, wall or ceiling fixture, with LED clusters or filament-LED lamps with a rustic look.

The series integrates beautifully in both country-classic and contemporary homes, and is suitable for hotels and public buildings as well.

[www.deltalight.us/montur](http://www.deltalight.us/montur)  
[www.deltalight.ca/montur](http://www.deltalight.ca/montur)



## FAMILY OVERVIEW

### COLOR



Black

### CHOOSE YOUR SHAPE & SIZE



Square / Rectangular  
Small / Medium

### CHOOSE YOUR LIGHT SOURCE

Integrated LED / E26

### CHOOSE YOUR POWER

4,2W up to 14W – 590 up to 2300lm

### CHOOSE YOUR COLOR TEMPERATURE

2700K / 3000K

### CONTROL

Non Dim

IP65

IK07

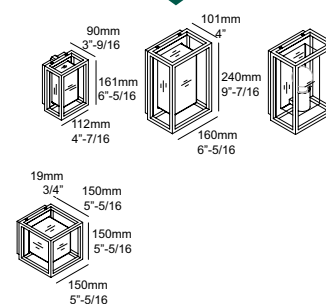





The Montur not only breathes new life into a classic concept, it also adds a detailed element of refinement. The sharply profiled framing in aluminium is utterly devoid of welding seams. For both the indoor and outdoor versions, there is a choice of finishing with either hand pressed transparent or opal glass.

The opal glass version contains a milky, cone shaped core, with a transparent glass surface, creating a pleasantly diffused light that gives the lamp extra cachet.

The indoor version of the Montur is also available as an open cube, with one or two bulbs.

By using them as outdoor fixtures, you can extend your lighting style into the garden or parking area. The outdoor versions are available in the same models as the indoor ones, but always feature a protective cover in glass or polycarbonate. There is also a bollard version, with a choice of various heights.





EXTERIOR WALL



The image features several large, angular, light-brown geometric blocks on a white surface against a light grey background. One block is a large triangle on the left, another is a trapezoid in the center, and a third is a rectangular block on the right. The lighting is soft, creating subtle shadows and highlights on the blocks' surfaces.

EXTERIOR

**FLOOR**

# RECESSED

**NEW**  
**LOGIC**  
P 514

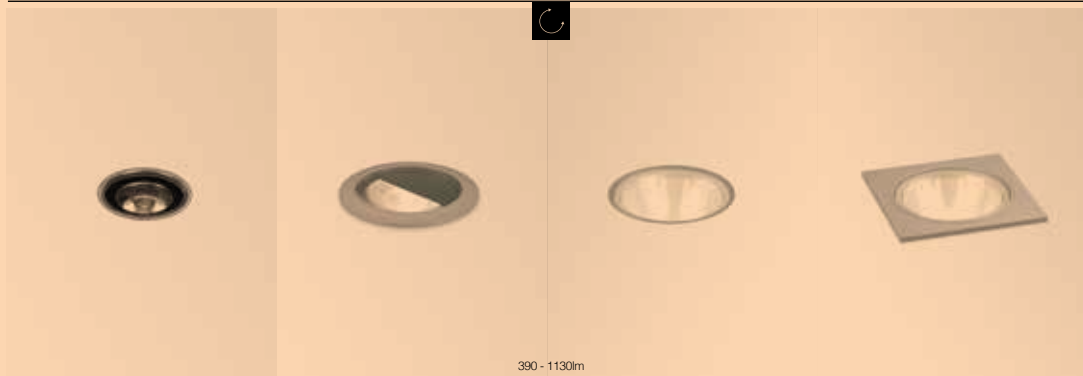

**LOGIC F**  
P 516



**LEDS C / GO**  
P 524

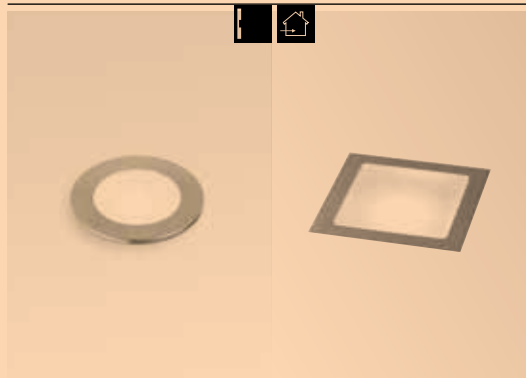

# SURFACE

EXTERIOR FLOOR

**KIX**  
P 528

**NEW**  
**FRAX**  
P 538



**MONTUR**  
P 546

**NEW**  
**WALKER II**  
P 552

**MONOPOL**  
P 556



**SPYKER**  
P 560

**BAZIL**  
P 564



LUMEN OUTPUT mentioned as indicative reach.



# LOGIC

Thanks to its multiple reflector options, Logic can be used to accentuate trees or sculptures, to light up facades or large garden features, to create a sense of depth or indicate the right direction along paths and driveways. The choice of installation – trimless or with trim – and its round or square shape allow you to match look & feel with the design of the building.

Within the same family, Logic W can be used as guidance light, built into the wall.

[www.deltalight.us/logic](http://www.deltalight.us/logic)  
[www.deltalight.ca/logic](http://www.deltalight.ca/logic)



## LOGIC 40

The Logic range stands for a complete family of water and shock resistant lighting fixtures. Logic 40 is the smallest of the family, a minimalistic recessed uplight with a diameter of only 40mm. With its small beam angle of 15°, it perfectly serves as an accent light to highlight any architectural aspect you want. Available with trim or as a trimless installation for an even more minimalistic look. To take care of the visual well-being, Logic 40 either comes with a micro vizor inside or as a Moon version, shielding off the light that is thrown backwards. The perfect addition to accentuate green or sculptures, to highlight façade or small garden features, to create a sense of depth or indicate the right direction along paths and driveways.

## LOGIC 60

With a diameter of only 2"-3/8" - 60mm, Logic 60 can easily be integrated in any landscape design, without disturbing the visual perception of it. Its smallest beam angle is ideal for highlighting, while the wallwash versions emphasize façades and bring depth into the architecture. The specific Moon version cuts off the light spill going backwards, ideal to accentuate trees or reduce the glare for passers-by.

## LOGIC 90

The bigger version of Logic allows for more choice in beam angles, letting the designer be creative and play with light effect and light intensity. Similar to Logic 60 also wallwash versions are available within the bigger range to offer multiple light effects within the same design language.





**FAMILY OVERVIEW**

**CHOOSE YOUR FINISH**



Anodized aluminium / Black / Inox

**CHOOSE YOUR POWER**

Ø 1"-5/8 - 40mm

3,9W - 390lm

Ø 2"-3/8 - 60mm

2W up to 7,1W - 230 up to 810lm

Ø 3"-9/16 - 90mm

2W up to 10,4W - 230 up to 1130lm

**CHOOSE YOUR COLOR TEMPERATURE**

3000K / 3500K

**CHOOSE YOUR OPTICS**

Ø 1"-5/8 - 40mm

15° / moon version

Ø 2"-3/8 - 60mm

6° / 20° / wallwash / moon version

Ø 3"-9/16 - 90mm

6° / 11° / 30° / 55° / wallwash

**IP67**

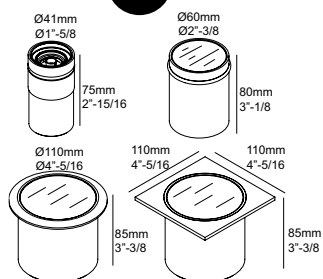

# LOGIC F

Logic F creates a playful effect on your path or driveway, perfect to enhance the architectural character of your project and landscape.

[www.deltalight.us/logic](http://www.deltalight.us/logic)  
[www.deltalight.ca/logic](http://www.deltalight.ca/logic)





**FAMILY OVERVIEW**

**CHOOSE YOUR FINISH**

●  
Alu Grey

**CHOOSE YOUR TYPE & POWER**

Single  
0,6W - 40lm  
—  
Double  
2 x 0,6W - 40lm

**CHOOSE YOUR COLOR TEMPERATURE**

3000K

●  
**IP67**

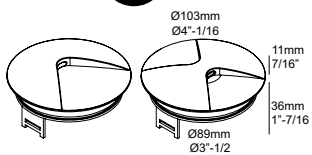







GOVAERT & VANHOUTTE ARCHITECTS









# LEDS C / GO

This family offers some miniature fixtures that serve as orientation and atmosphere lighting. Available in round and square, these little dots of light are perfect as guidance lights.

While Leds C II can be used indoors - for example as safety light in corridors and hallways -, Leds C R ST and Leds Go will guide the way outdoors - along paths and driveways.

[www.deltalight.us/leds-c](http://www.deltalight.us/leds-c)  
[www.deltalight.ca/leds-c](http://www.deltalight.ca/leds-c)

[www.deltalight.us/leds-go](http://www.deltalight.us/leds-go)  
[www.deltalight.ca/leds-go](http://www.deltalight.ca/leds-go)

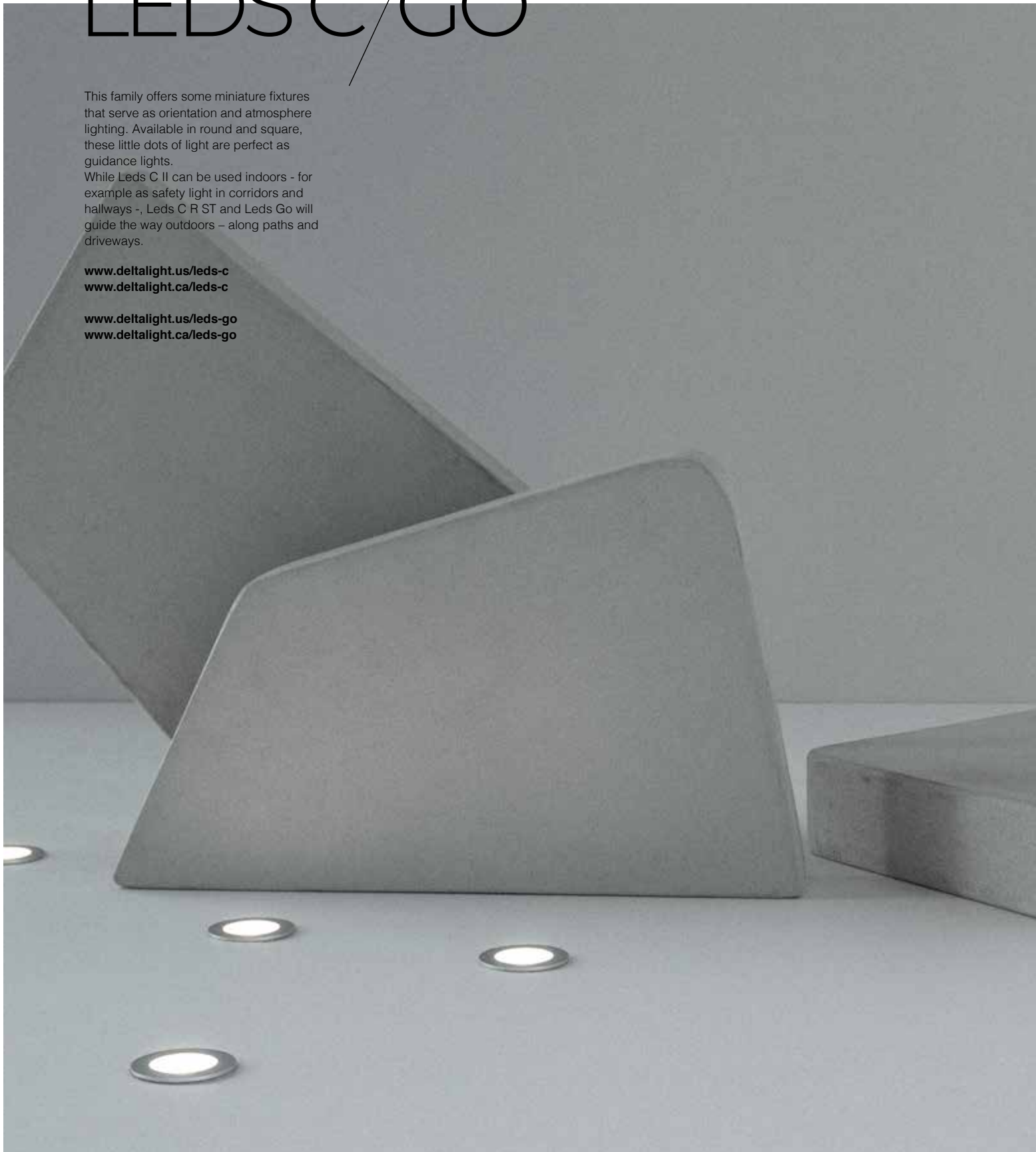

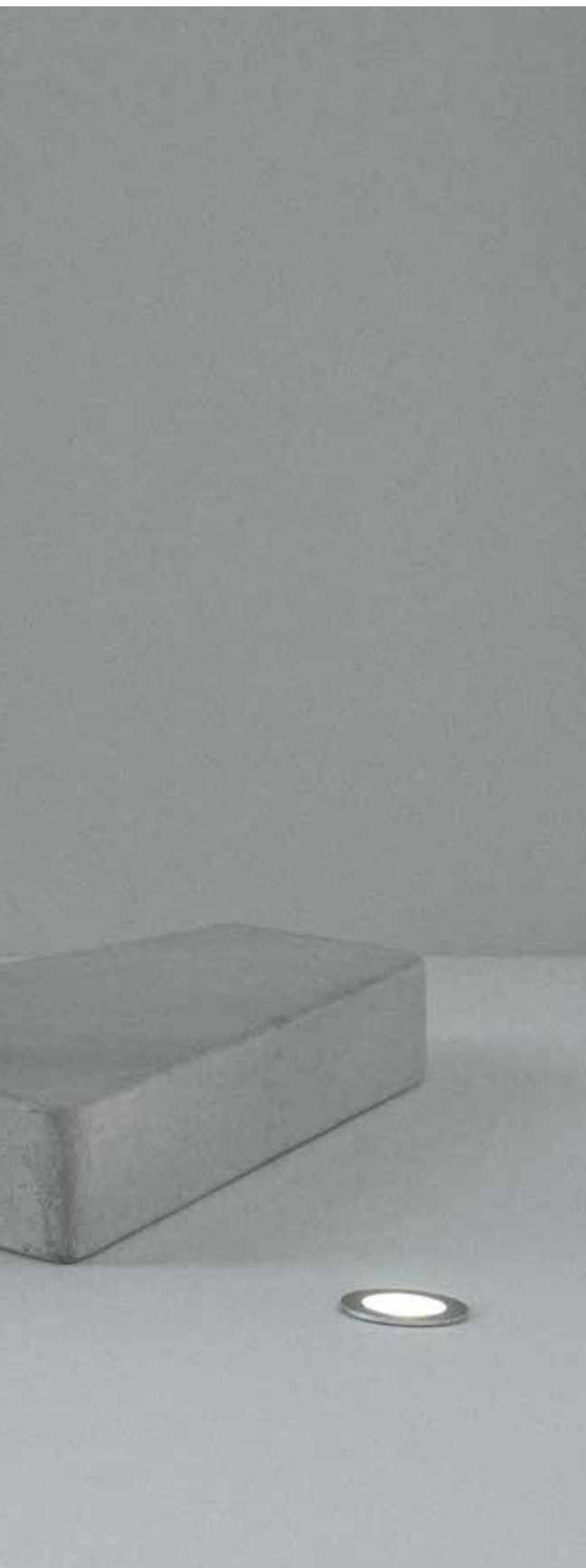

**FAMILY OVERVIEW**

**COLOR**



Anodized aluminium

**POWER**

1,1W – 130lm

**CHOOSE YOUR COLOR TEMPERATURE**

3000K / 4000K

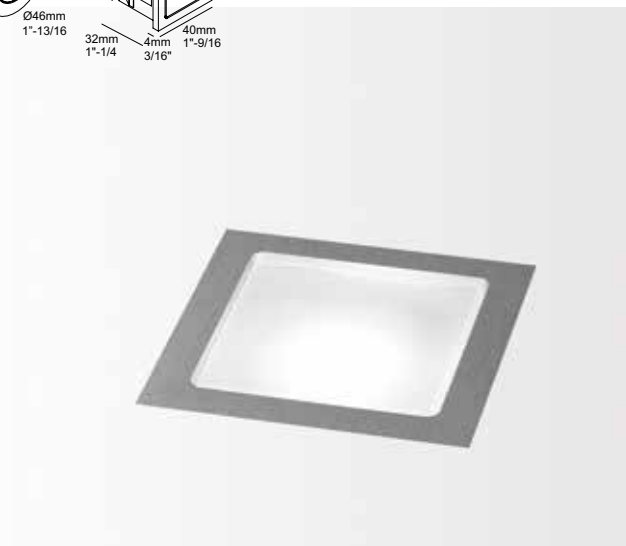
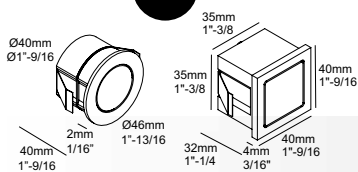

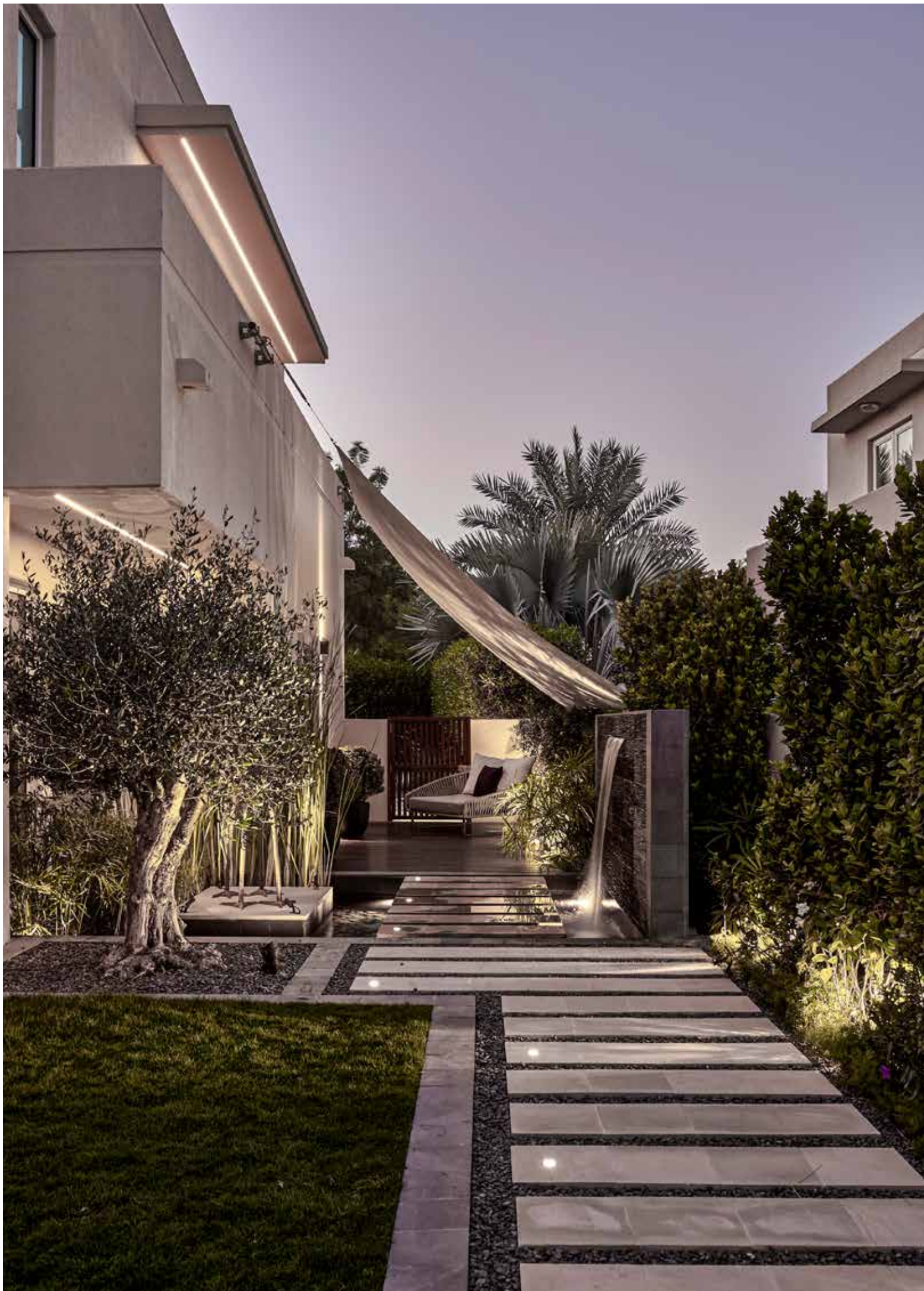



# KIX

Flexible, subtle, elegant and powerful: these are the keywords that describe the Kix perfectly. Despite its low-profile appearance, Kix excels in light output and quality, ideal for walkway lighting or other landscape applications. Kix is easy and flexible to use thanks to the adjustable head, designed to provide optimal cooling and eliminate glare.

Kix is available for installation on wall or floor, to strap around a tree or to mount in soft green areas with a pin. In addition to the more robust version of Kix, there is also a S(mall) and M(edium) version available. Kix S combines a powered led with a lens, resulting in a nice 10° light beam. All models have an IP65 rating and are available in alu grey or dark grey.

[www.deltalight.us/kix](http://www.deltalight.us/kix)  
[www.deltalight.ca/kix](http://www.deltalight.ca/kix)



**FAMILY OVERVIEW**

**CHOOSE YOUR FINISH**



Alu Grey / Dark Grey

**CHOOSE YOUR POWER**

Small

1W up to 2W - 130 up to 250lm

Medium

6,4W - 590lm

Large

7,1W up to 16,3W - 810 up to 2310lm

**CHOOSE YOUR COLOR TEMPERATURE**

3000K / 3500K

**CHOOSE YOUR OPTICS**

Small

10°

Medium

30°

Large

11° / 30° / 55° / 120°

**CHOOSE YOUR ACCESSORY**

Honeycomb / Kap

**CHOOSE YOUR INSTALLATION**

Surface mounted on paved surfaces

On a pin between the green

Strapped around a tree

**IP65**

**IK07**

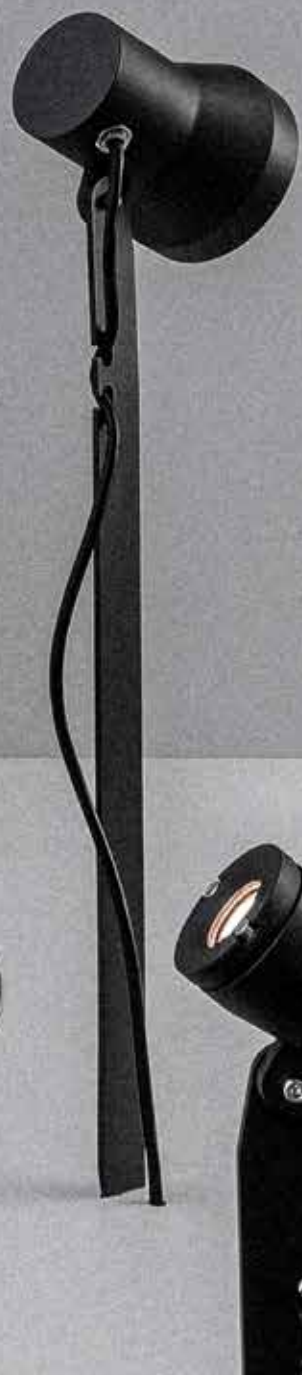
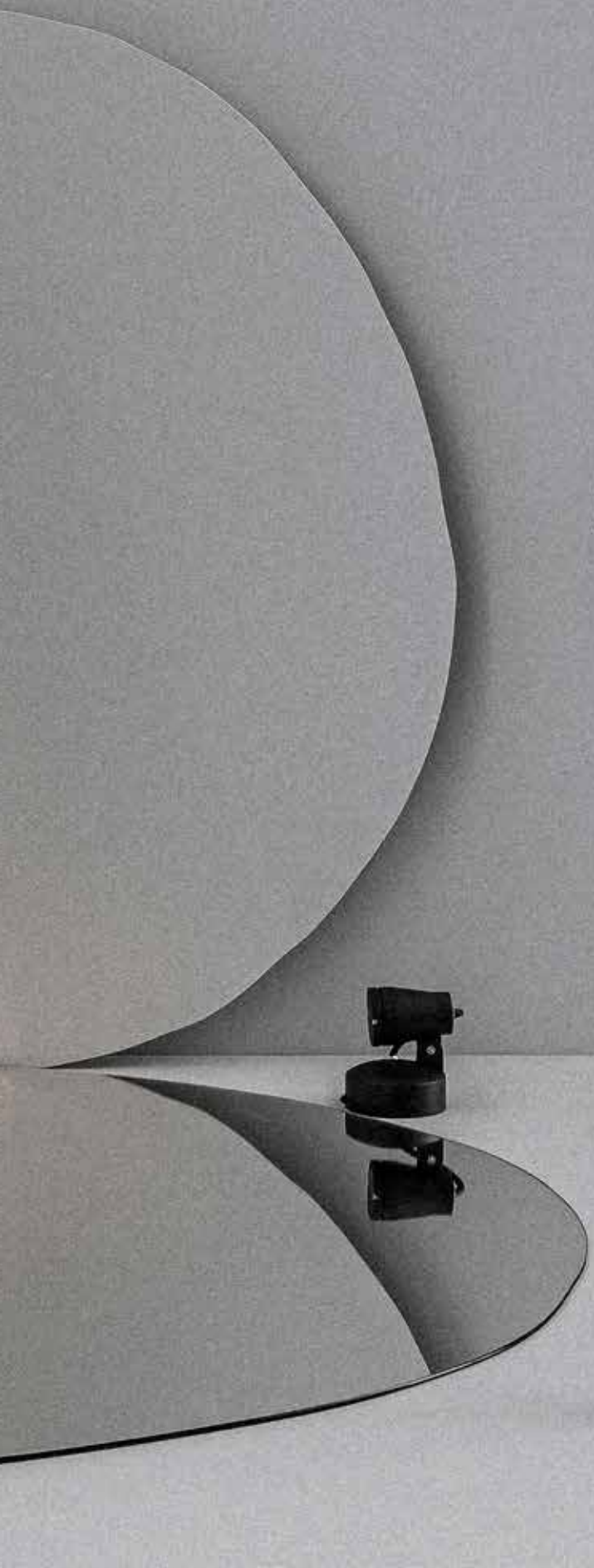
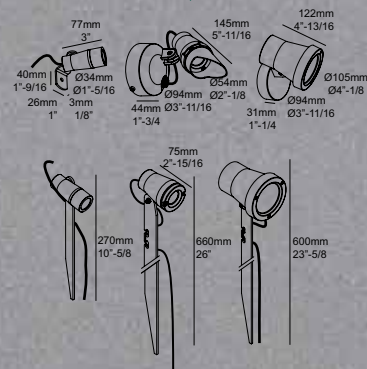





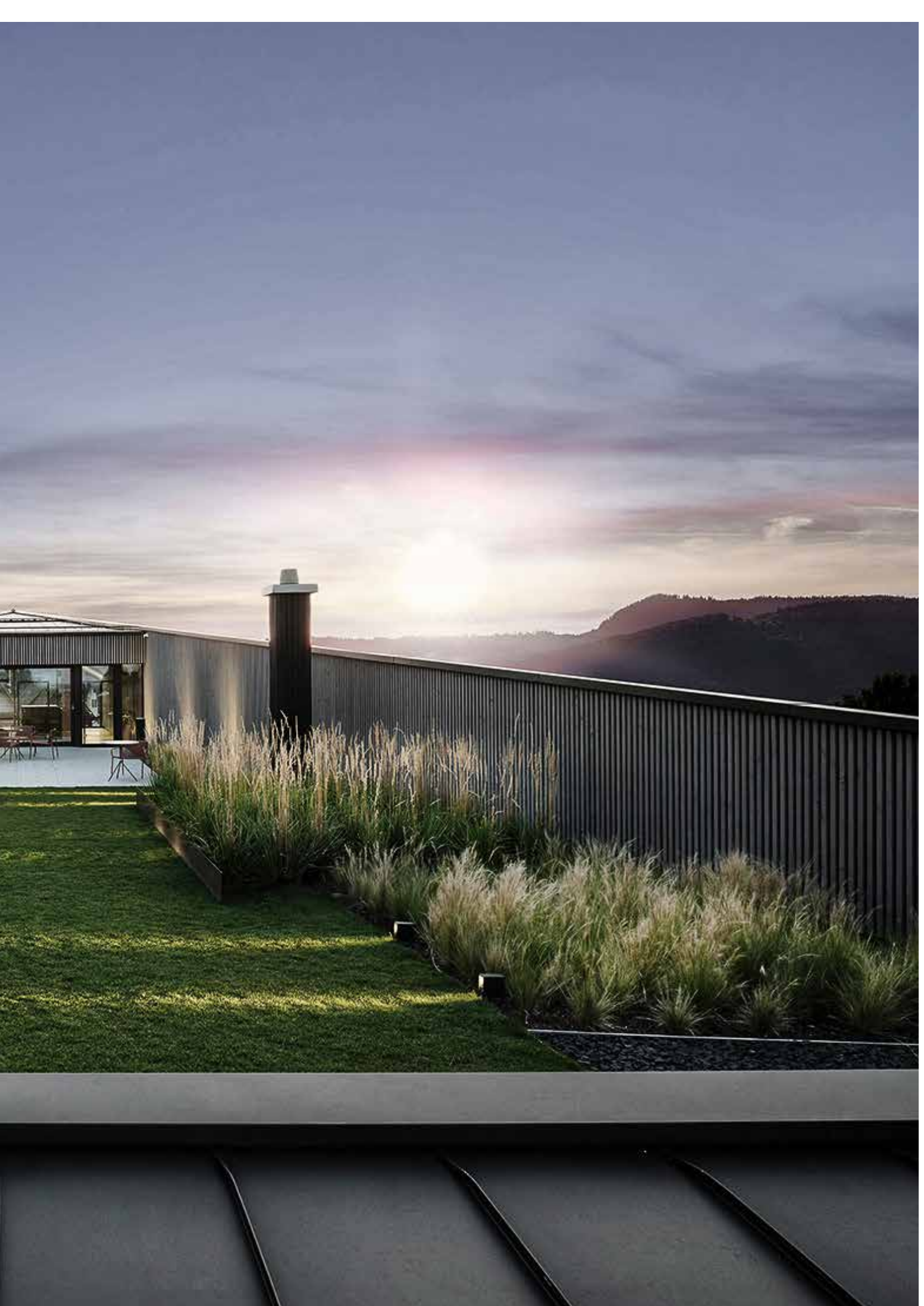



ARCHITECT ANARCHITECT - PHOTO LUCA CIOCI





PHOTOGRAPHY GAVRIIL PAPADIOTIS - GAVRIILLUX









Light and ambiance is not only for indoors, by combining light and architecture in outdoor settings, the city also remains vibrant at night. With its 7 different light effects and its multiple installation options, Frax has been designed for every aspect of the urban architecture: any form, any material or any composition.

# FRAX

[www.deltalight.us/frax](http://www.deltalight.us/frax)  
[www.deltalight.ca/frax](http://www.deltalight.ca/frax)



**OPTICAL PRECISION  
LED Caset Technology**

Frax is based on Delta Light's LED Caset technology, which combines multiple LEDs with individual collimator lenses per LED to generate a clean-cut light distribution.

The individual lenses create a multi-layered light distribution to generate a clean 8° or 14° beam angle.

Other beam angles or other light effects are being obtained by adding microlenses in front, sculpting the light into a 26° or 47° beam angle or into a linear or wallwash effect.



**VISUAL WELL-BEING**

Frax not only cares about the perfect light effect, it takes care about the passer-by as well.

Frax can be provided with an additional honeycomb or a snoot to reduce the possibility from directly looking into the light source.

Both of them reduce any undesired light effect and the glare associated with it.



**MADE FOR HARSH ENVIRONMENTS**  
**IP65**

IK06 thanks to 3/16" - 5mm thick glass for Frax S  
IK08 thanks to 5/16" - 8mm thick glass for Frax M

UV-resistant components for extended lifespan

Thermal protector inside to prevent the luminaire from overheating

D-Lock: in-house designed moisture lock to prevent humidity entering the luminaire

**FAMILY OVERVIEW**

**CHOOSE YOUR FINISH**



Dark Grey / Grey

**CHOOSE YOUR POWER**

Small: 5,9 up to 7,9W - 650 up to 870lm  
 Medium: 17,9W up to 23W - 1800 up to 2400lm

**COLOR TEMPERATURE**

3000K

**CHOOSE YOUR OPTICS**

8° / 14° / 26° / 47°

Other effects:  
 linear spread / wallwash

**CHOOSE YOUR CONTROL**

Non Dim / Phase Dimming

**CHOOSE YOUR ACCESSORY**

Honeycomb

**CHOOSE YOUR INSTALLATION**

Surface mounted on paved surfaces  
 On a pin between the greenery  
 Strapped around a tree  
 Mounted on a pole

**IP65**

**IK06 IK08**



**INSTALLATION MADE EASY**

Apart from the extensive optical possibilities, Frax also offers a range of different mounting options. Standard, the luminaire comes on a round base, but one can also opt to install the luminaire head on a pin, on a strap or on a simplified bracket. In this way, Frax can easily be transformed to install in between the greenery, around a tree, a pole or any other surface. To facilitate the installation of multiple Frax luminaires, a degree scale is integrated on the hinge, perfect for precise aiming and a proper repetitive light effect.



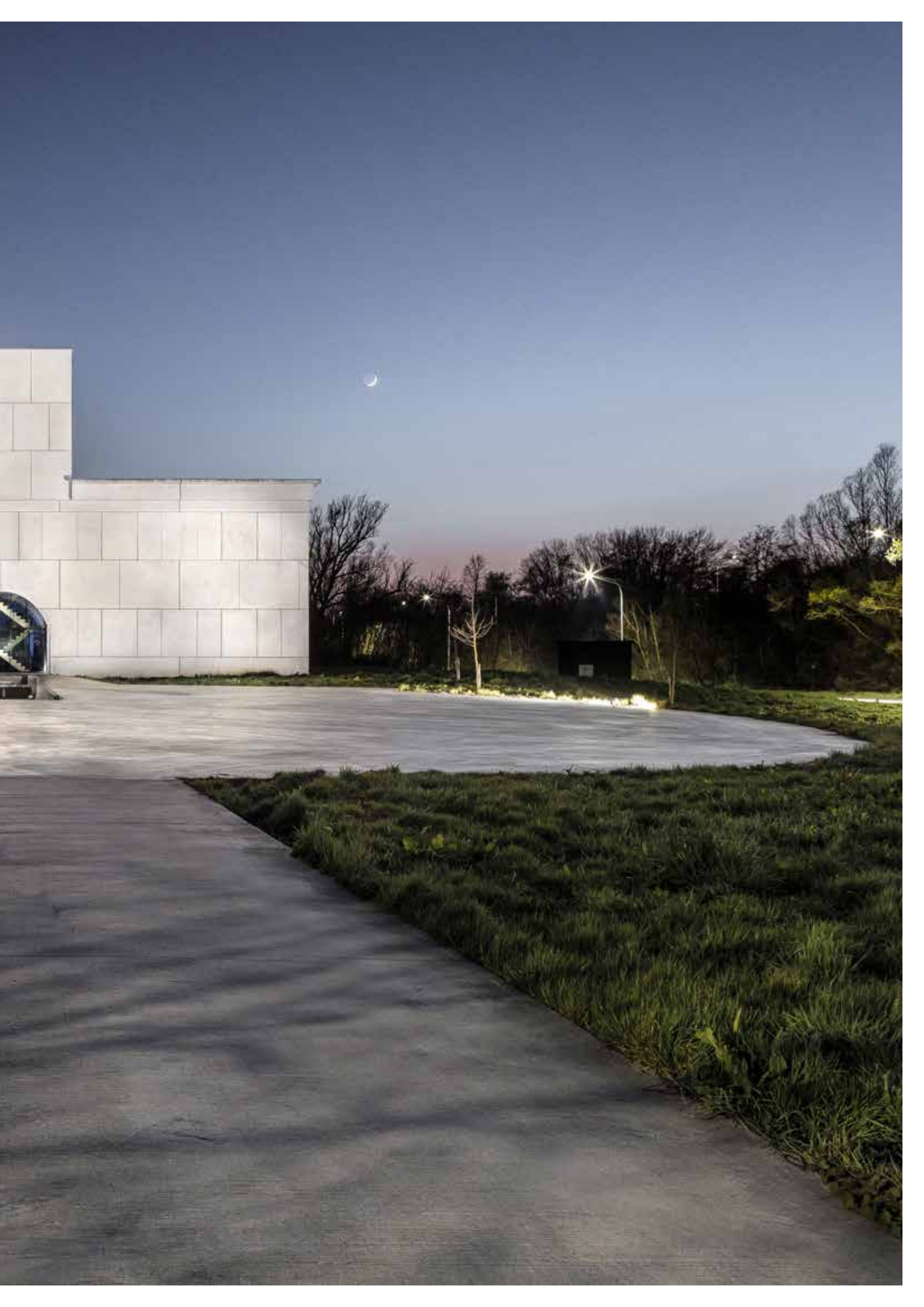





With Montur we offer a highly original interpretation of an archetypical concept: a light source that is contained within the framing of a 3D square or rectangular shape. The Montur is available in indoor and outdoor versions, as a ground, wall or ceiling fixture, with LED clusters or filament-LED lamps with a rustic look. The series integrates beautifully in both country-classic and contemporary homes, and is suitable for hotels and public buildings as well.

The Montur not only breathes new life into a classic concept, it also adds a detailed element of refinement. The sharply profiled framing in aluminium is utterly devoid of welding seams. For both the indoor and outdoor versions, there is a choice of finishing with either hand pressed transparent or opal glass. The opal glass version contains a milky, cone shaped core, with a transparent glass surface, creating a pleasantly diffused light that gives the lamp extra cachet. The indoor version of the Montur is also available as an open cube, with one or two bulbs. By using them as outdoor fixtures, you can extend your lighting style into the garden or parking area. The outdoor versions are available in the same models as the indoor ones, but always feature a protective cover in glass.

There is also a bollard version, with a choice of various heights.

[www.deltalight.us/montur](http://www.deltalight.us/montur)  
[www.deltalight.ca/montur](http://www.deltalight.ca/montur)





**FAMILY OVERVIEW**

**COLOR**



Black

**CHOOSE YOUR VERSION**

Milky glass / Without glass

**CHOOSE YOUR POWER**

6W up to 13,3W - 1000 up to 1250lm

**CHOOSE YOUR CONTROL**

Non Dim / Phase Dimming

**COLOR TEMPERATURE**

3000K

**CHOOSE YOUR HEIGHT**

12"-5/8 - 320mm

17"-3/16 - 436mm

26"-3/8 - 670mm

36"-1/4 - 920mm

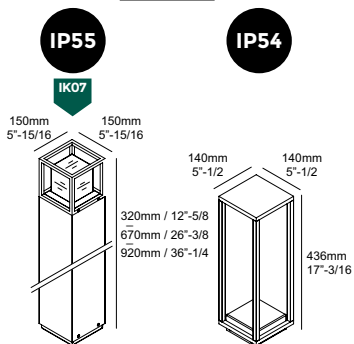

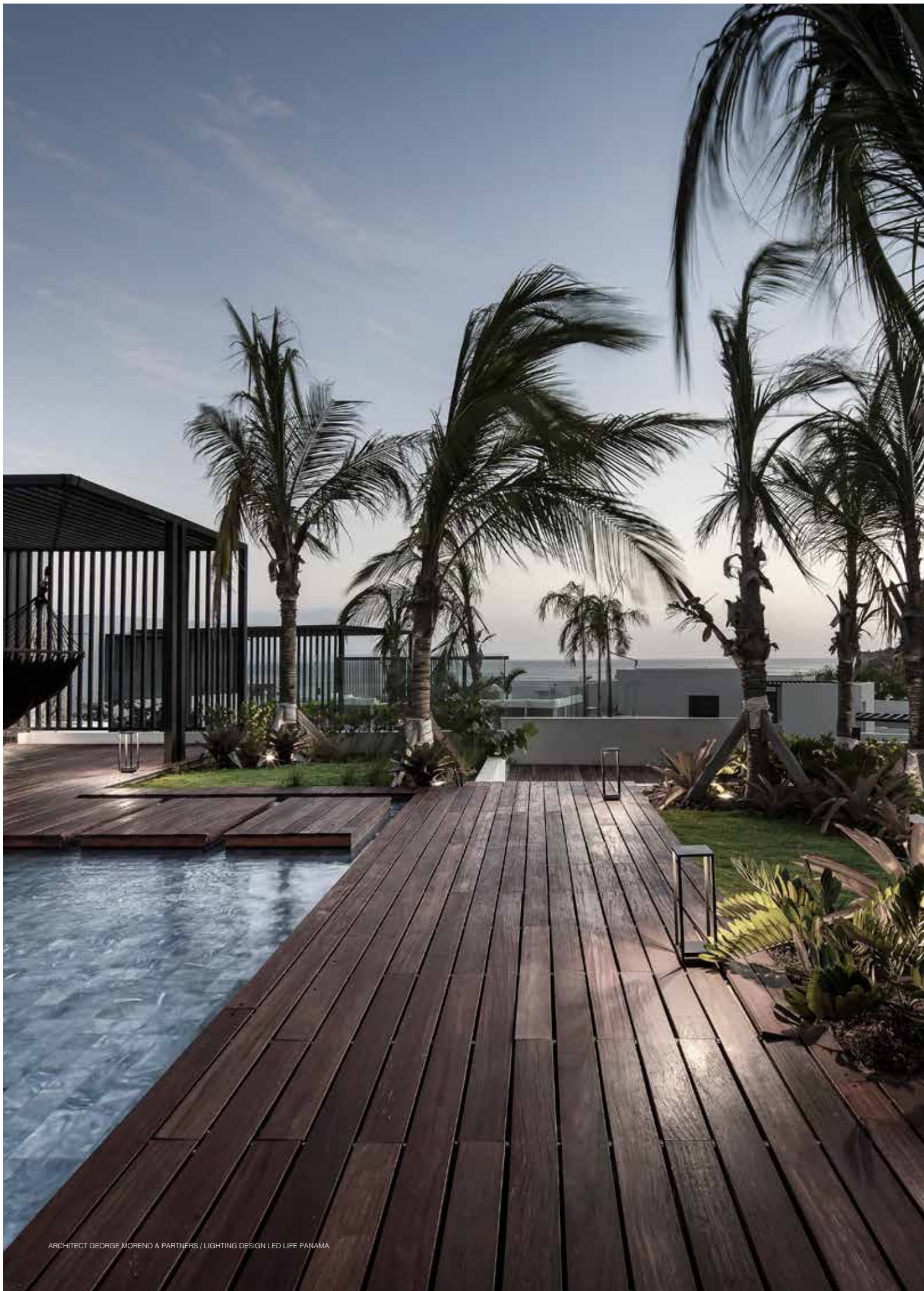



GOVAERT & VANHOUTTE





# WALKER II

## SPLIT THE LIGHT

Walker II splits the light open. Starting from 1 light source, Walker II is designed to guide the light into two directions to provide a double light effect on the surface below.

The light falls on the V-shaped inner part of the luminaire, breaking it open and throwing it to the front- and backside of the luminaire.

Walker II can serve as a guiding light on your wall or pathway, as it comes as a wall luminaire and as a bollard. Different sizes, different heights and multiple color combinations can be combined to your preference to create the perfect setting.

[www.deltalight.us/walker-ii](http://www.deltalight.us/walker-ii)

[www.deltalight.ca/walker-ii](http://www.deltalight.ca/walker-ii)

## FAMILY OVERVIEW

### CHOOSE YOUR FINISH



Dark Grey / Alu Grey

Dark Grey-Gold Colored / Alu Grey-Dark Grey

### CHOOSE YOUR POWER

5,2W - 670lm

6,2W - 790lm

### CONTROL

Non Dim

### CHOOSE YOUR COLOR TEMPERATURE

2700K / 3000K

### CHOOSE YOUR HEIGHT

15"-3/4 - 400mm

27"-9/16 - 700mm

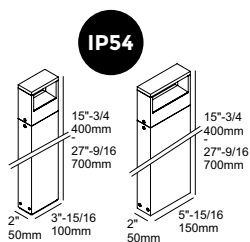

EXTERIOR FLOOR

Find the other members of this family **INTERIOR / EXTERIOR WALL**











# MONOPOL

Monopol is a bollard taking on the shape of a slender girder, rising from the ground up. Minimalistic in design, straightforward in functionality as it produces a very focused spread of light through its narrow opening at the front. Available in 2 sizes, 2 colors and perfect to create a play of light on paths or driveways.

[www.deltalight.us/monopol](http://www.deltalight.us/monopol)  
[www.deltalight.ca/monopol](http://www.deltalight.ca/monopol)

## FAMILY OVERVIEW

### CHOOSE YOUR FINISH



Alu Grey / Dark Grey

### POWER

7,1W – 810lm

### CONTROL

Phase Dimming

### CHOOSE YOUR COLOR TEMPERATURE

3000K / 3500K

### CHOOSE YOUR HEIGHT

10"-1/4 - 260mm / 27"-9/16 - 700mm

**IP55**

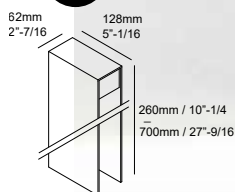







# SPYKER

The Spyker is characterized by a circular base and a wider aluminium disc on top, holding a circular cluster of LEDs. This outdoor lighting solution is available in 2 heights and comes in alu grey or dark grey. Thanks to 2 different optics, Spyker offers 2 different light effects: the first optic creates a general light, uniform around the luminaire, while the second optic results in a circular line of light embracing the luminaire like a halo.

[www.deltalight.us/spyker](http://www.deltalight.us/spyker)  
[www.deltalight.ca/spyker](http://www.deltalight.ca/spyker)

## FAMILY OVERVIEW

### CHOOSE YOUR FINISH



Alu Grey / Dark Grey

### CHOOSE YOUR OPTICS

General light effect  
 Centric light effect

### POWER

7,1W – 810lm

### CONTROL

Phase Dimming

### CHOOSE YOUR COLOR TEMPERATURE

3000K / 3500K

### CHOOSE YOUR HEIGHT

14"-5/8 - 371mm / 26"-7/16 - 671mm



IK08

Ø100mm  
 Ø3"-15/16

18mm  
 11/16"

14"-5/8 - 371mm  
 26"-7/16 - 671mm

Ø60mm  
 Ø2"-3/8

15mm  
 9/16"

Ø92mm  
 Ø3"-5/8



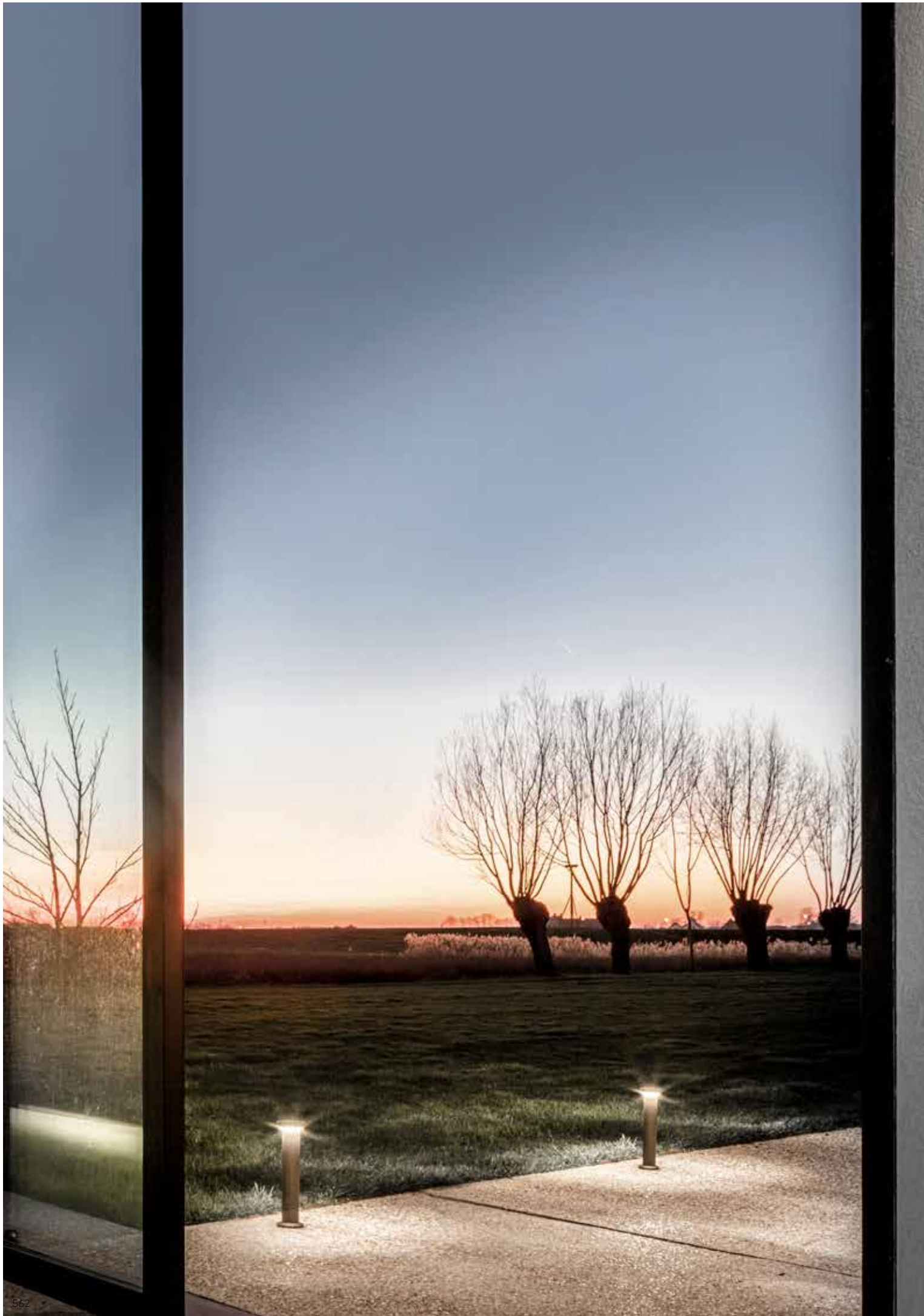







# BAZIL

Bazil is characterized by an aluminum disc which holds a ring of leds, supported by a softly curved body that serves as a reflector, combining design and functionality. The result is a pleasant, soft light that poses no risk of dazzling. The large and more robust model fits perfectly around office buildings, public buildings, hotels and grand houses. Bazil comes in different color combinations, including Delta Light's unique dark grey.

[www.deltalight.us/bazil](http://www.deltalight.us/bazil)  
[www.deltalight.ca/bazil](http://www.deltalight.ca/bazil)



**FAMILY OVERVIEW**

**CHOOSE YOUR FINISH**



Alu Grey-Anodized / Dark Grey-Anodized

**CHOOSE YOUR POWER**

11W - 730lm  
15W - 1020lm

**CONTROL**

Non Dim

**CHOOSE YOUR COLOR TEMPERATURE**

3000K

**CHOOSE YOUR HEIGHT**

14"-3/8 - 365mm  
28"-3/16 - 715mm



Ø140mm

Ø5"-1/2

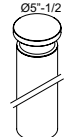

Ø120mm

Ø4"-3/4

120mm

13/16"

14"-3/8 - 365mm

28"-3/16 - 715mm



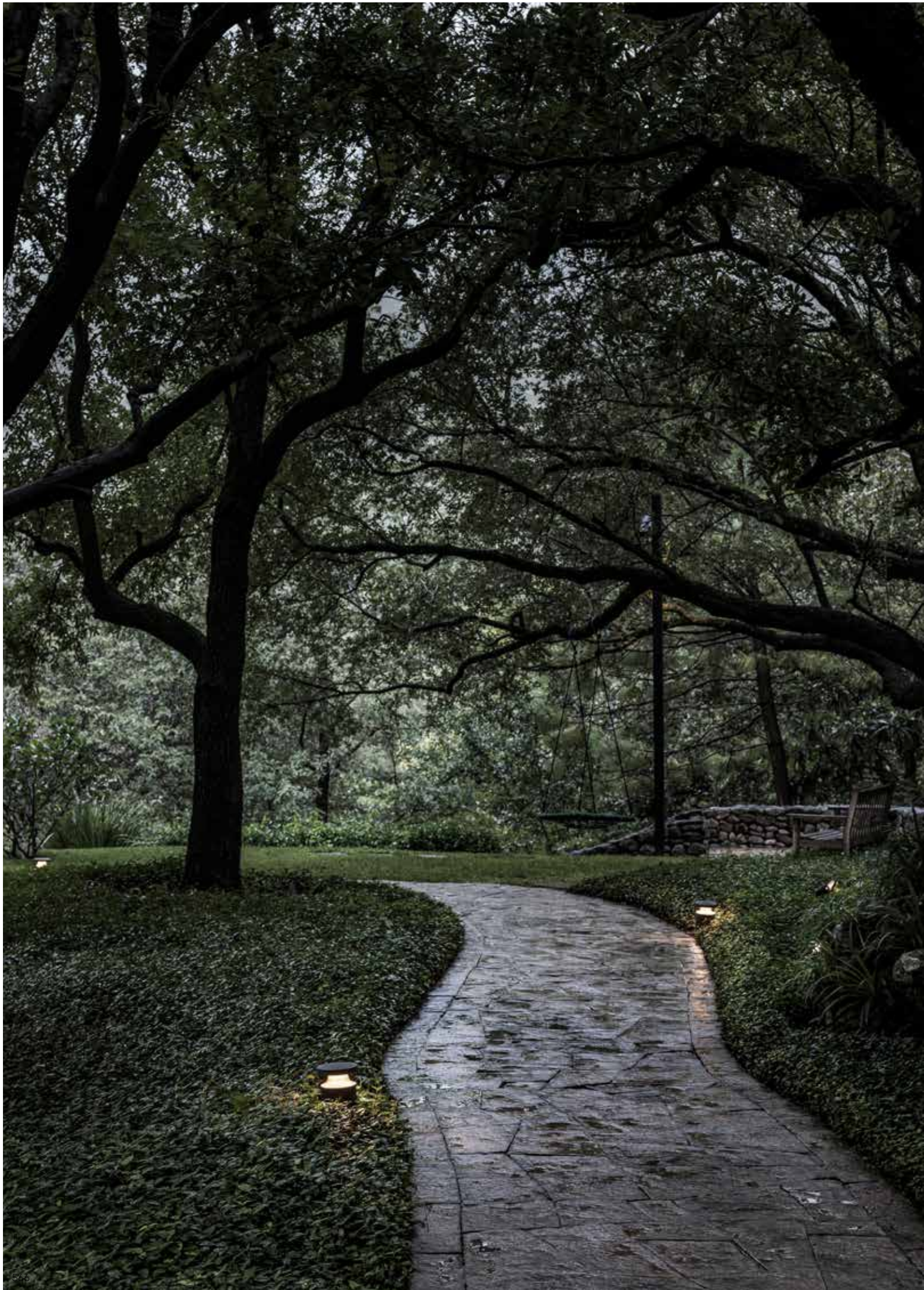

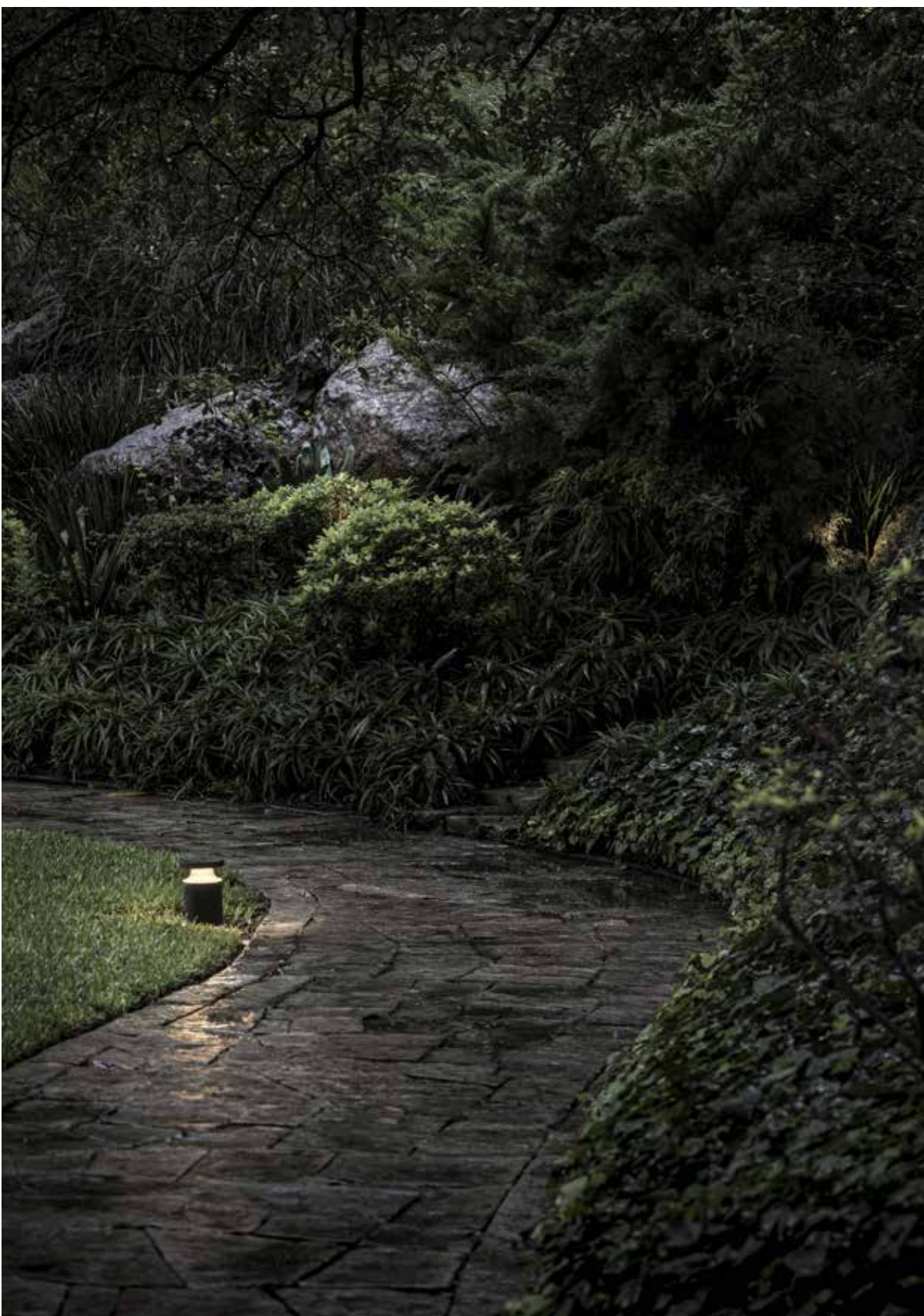

ATRIO INTERIORES





# A FAMILY BUSINESS

Delta Light's success is built on the determination, passion, and talent of our global team. We hereby thank all of our colleagues and partners for their invaluable work.

The lighting industry is evolving and growing at very high speed.

As a family run business, we have a personal stake in keeping our clients happy. As such we are committed in making a difference through original designs, outstanding service levels, an eye for detail and personal contact and striving to be the best in all we do.

Our product development process is based on a combination of creativity and technological innovation. It is our mission to present to the world a portfolio of lighting solutions that satisfy people's desires and needs, realise peoples visions, whilst creating a perfect symbiosis between architecture, function and atmosphere.





# THE MAKING OF THE LIGHTING BIBLE

**THE LIGHTING BIBLE 14** is entirely created in-house, by a dedicated team, supported by colleagues from all departments. Are you wondering how it all went down? We lift a tip of the veil with this behind-the-scenes footage.

No photographers were harmed during this period.

A special thank you to our coffee machine,  
who was always there for us.

We were instructed by our Art Director  
to write a kind thank you note towards him...  
So here it comes:

Lorem ipsum dolor sit amet, consectetur adipiscing elit. Donec in justo eu quam ultrices commodo. Vivamus posuere orci congue tortor pellentesque viverra. Pellentesque pharetra, mauris ut consectetur placerat, purus ex feugiat nibh, a commodo velit nibh a lacus. Hebban olla vogala nestas hagunnan hinase hic enda thu hoe mehr vogala hoe betera. Quisque in volutpat nisi, sed tristique mi. Integer ultrices massa nec sapien tristique suscipit. In pellentesque, leo Frituur Magalie fermentum, magna Sammie blandit nulla, a malesuada justo mauris ut tellus.

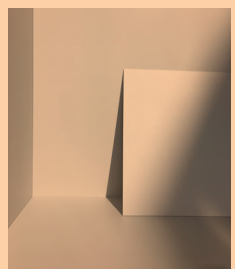
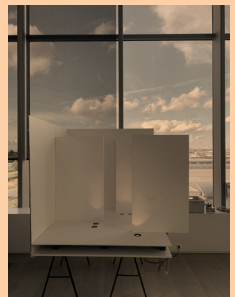
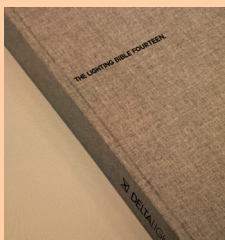
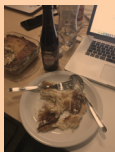
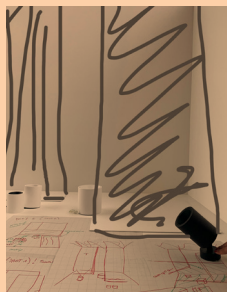
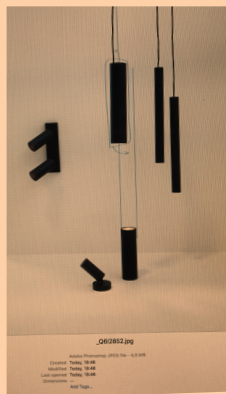
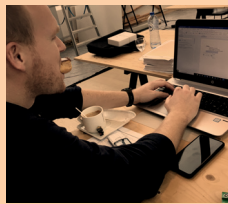



# WORLDWIDE

For additional product information,  
technical downloads, project inspiration,  
contact details and much more... please go to

[www.deltalight.us](http://www.deltalight.us)  
[www.deltalight.ca](http://www.deltalight.ca)

Whether you access the site via your desktop computer or mobile device, an inspiring platform opens up with up-to-date content, exciting images, extensive product information, upgraded user experience... all in a fresh look & feel.

The **product search engine** will quickly guide you to the right product page, where you can download 3D files, Revit files, product data sheets, manual, IES files and drawings.

#### The **My Delta Light Toolbox**

helps you to quickly collect, save, download and share images and product information. Start creating your personal shortlists and share them with your partner, client, architect, electrical installer or other people involved in your project. You are free to use this feature without login, or you can register to save and edit multiple pinlists.

If you are looking for a contact person in your region or country please go to

[www.deltalight.us/contact](http://www.deltalight.us/contact)  
[www.deltalight.ca/contact](http://www.deltalight.ca/contact)

#wearedeltalight

# HQ

**Headquarters  
Delta Light nv**  
Muizelstraat 2  
B-8560 Wevelgem (Moorsele)  
Belgium  
T +32 (0)56 435 735  
F +32 (0)56 435 736  
info@deltalight.com  
www.deltalight.com

# OFFICES

## ASIA

**Delta Light Asia**  
asia@deltalight.com  
www.deltalight.asia

**South East Asia**  
T +65 9832 3753

**North East Asia**  
T +852 9293 0096

## CHINA

**Delta Light China**  
china@deltalight.com  
www.deltalight.com

**Beijing**  
T+86 138 1070 8782

**Shanghai**  
T+86 135 8578 5451

## LATIN AMERICA

**Delta Light Latin America**  
M +32 492 724 070  
latin@deltalight.com  
www.deltalight.com

**Colombia**  
T +57 1 749 5307  
M +57 321 202 5501  
M +57 312 301 3823  
Colombia@deltalight.com

**Mexico**  
Mexico@deltalight.com

**Mexico City**  
M +52 556 204 1203

**Monterrey**  
M +52 181 3081 4196

## RUSSIA / EASTERN EUROPE / MIDDLE ASIA

**Delta Light REEMA**  
reema@deltalight.com  
www.deltalight.ru

**Moscow**  
T +7 926 167 76 98

**Saint-Petersburg**  
T +7 921 79 183 88

## UNITED KINGDOM

**Delta Light UK LTD**  
T +44 (0)20 7960 5030  
uk@deltalight.com  
www.deltalight.co.uk

## BELGIUM / LUXEMBOURG

**Delta Light nv**  
T +32 (0)56 435 735  
F +32 (0)56 435 736  
belux@deltalight.com  
www.deltalight.be

## FRANCE

**Delta Light SAS**  
T +33 (0)9 70 73 52 42  
T +33 (0)9 70 73 52 43  
france@deltalight.com  
www.deltalight.fr

## SLOVAKIA

**Delta Light Slovakia s.r.o.**  
T +421 2 6353 0180  
F +421 2 6353 0181  
slovakia@deltalight.com  
www.deltalight.sk

## USA

**Delta Light USA, LLC.**  
T +1 (954) 677 9800  
F +1 (954) 677 1007  
usa@deltalight.us  
www.deltalight.us

**New York**  
T +1 (646) 973-3284  
nyc@deltalight.us

**Los Angeles**  
T +1 (213) 289-3048  
la@deltalight.us

**Miami**  
T +1 (954) 677-9800  
miami@deltalight.us

## CANADA

**Delta Light Canada Inc.**  
T +1 905 813 6130  
F +1 289 805 7388  
canada@deltalight.com  
www.deltalight.ca

## GERMANY / AUSTRIA

**Delta Light GmbH**  
T +49 (0)2451 4090-0  
F +49 (0)2451 4090-200  
germany@deltalight.com  
www.deltalight.de

## MIDDLE EAST / NORTH AFRICA

**Delta Light Mena**  
T +961 1 491 175  
mena@deltalight.com  
www.deltalight-mena.com

**Dubai  
Delta Light EMEA**  
T +971 52 530 35 90  
uae@deltalight.com

## SPAIN

**Iluminación Delta Light España S.A.**  
T +34 (0)93 586 19 00  
F +34 (0)93 697 95 00  
spain@deltalight.com  
www.deltalight.es

## CZECH REPUBLIC

**Delta Light Czech s.r.o.**  
T<sup>1)</sup> +420 241 740 775  
T<sup>2)</sup> +420 241 740 776  
czech@deltalight.com  
www.deltalight.cz

## INDIA

**Delta Light India**  
T +9111 4056 2720  
india@deltalight.com  
www.deltalight.com

## THE NETHERLANDS

**Delta Light Nederland B.V.**  
T +31 (0)88 80 40 600  
F +31 (0)88 80 40 699  
netherlands@deltalight.com  
www.deltalight.nl

## SWITZERLAND

**Delta Light AG**  
T +41 (0)61 485 99 10  
F +41 (0)61 485 99 11  
switzerland@deltalight.com  
www.deltalight.ch

## ITALY

**Delta Light Italia S.r.l.**  
T +39 02 2305 6210  
F +39 02 2316 6064  
italy@deltalight.com  
www.deltalight.it

## POLAND

**Delta Light Poland**  
T +48 698 33 00 03  
poland@deltalight.com  
www.deltalight.pl

**Manufacturer Delta Light nv**

**Product Design - Research - Development:** Delta Light Team & Nice 2C

**Coordination - Concept:** Delta Light Team & Nice 2C

**Graphic Design - Realisation:** Delta Light Team & Nice 2C

Finally, to everyone who contributed in some way  
to the realisation of this Lighting Bible...

**Thanks.**

Copyright © Delta Light nv  
DOC 100 00013  
Made in Belgium

For the latest edition of the Lighting Bible, please visit

**[www.deltalight.us](http://www.deltalight.us)**  
**[www.deltalight.ca](http://www.deltalight.ca)**

All information in this catalogue is provided for information purposes only and Delta Light NV makes no representations about the accuracy or completeness of the information in this catalogue.

Delta Light NV may, in its sole discretion, revise the information and technical data contained herein at any time without notice. The catalogue does not contain any guarantee on the Delta Light NV products nor any warranty of merchantability or fitness for a particular purpose or use

All Delta Light products are supplied without lamps and any lamp data is given as a mere example.

The general terms & conditions of Delta Light NV shall be applicable on each sale of a Delta Light product.

Any trademarks, texts, images, graphics, designs and other information in this catalogue are the sole property and subject to the intellectual property rights of Delta Light NV and may not be copied, modified or used for any purpose without Delta Light's prior written consent.









~~IMAGINE~~

 DELTALIGHT®

